

Elements of Ammunition

By

Major THEODORE C. OHART

Ordnance Department, Army of the United States

JOHN WILEY & SONS, Inc., New York

CHAPMAN & HALL, Limited, London

BUREAU OF SHIPS LIBRARY



THIS BOOK HAS BEEN MANUFACTURED IN
ACCORDANCE WITH THE RECOMMENDATIONS
OF THE WAR PRODUCTION BOARD IN THE
INTEREST OF THE CONSERVATION OF PAPER
AND OTHER IMPORTANT WAR MATERIALS.

COPYRIGHT, 1946
BY
JOHN WILEY & SONS, INC.

All Rights Reserved

*This book or any part thereof must not
be reproduced in any form without
the written permission of the publisher.*

PRINTED IN THE UNITED STATES OF AMERICA

To My Wife

*Whose help and understanding have
made this book possible.*

FOREWORD

In volunteering to prepare this brief introduction or foreword for Major Ohart's excellent volume, *The Elements of Ammunition*, I feel that I am speaking for that pathetically small group of ordnance officers (of which I was one), and an equally small group of civilian employees, who were charged with the heavy and almost unbearable responsibility of handling the ammunition program during the critical years from 1937 to 1942.

It was realized very early that the gigantic ammunition program which soon would fall upon the Ordnance Department would require, for its successful prosecution, many hundreds of trained ammunition technicians in the various agencies involved in the program. With every available minute devoted to grappling with the myriad details involved in preparing and launching this program, there remained no time for us to properly instruct and assimilate the ever-increasing influx of personnel, yet we realized all too keenly that the job must be done. Somehow we muddled through, as the success of the ammunition program will attest. But how we wished in those early days for a "book" that could be handed to these newcomers to study and absorb quickly the essence of what they would need to know to handle their jobs; a book that would answer most of their many questions and leave us free to work on the big task that confronted us. *The Elements of Ammunition* is such a book.

It remained for the author to undertake the arduous and difficult task of compiling and arranging the wealth of the material which must be presented in a book of this type. The author is uniquely fitted for the task he set for himself, having been connected with the Technical Division at Picatinny Arsenal since 1940, and during much of that time he was directly in charge of a large group engaged in the design and development of the ammunition dealt with in this book. During this period he has from time to time lectured to groups of officers at Picatinny Arsenal and has conducted extension courses in ammunition under the auspices of Rutgers University. Much of the material in his book was prepared for use in these courses and lectures and has therefore had the benefit of an exacting trial run, so to speak.

It may be said then that the author's work represents an attempt to fill a very definite need. The various official training manuals and

technical bulletins are excellent in their field but, of course, do not present information from the ammunition designer's point of view but rather that of the user. Available information of the textbook variety includes two chapters devoted to ammunition in Hayes's *Elements of Ordnance* (1937); also the voluminous and well-known four-volume mimeographed text (1939) prepared at Picatinny Arsenal for use in the short training courses for selected reserve officers reporting for duty in the new mass-production loading plants. Some work has been done by various ordnance engineers at Picatinny Arsenal toward preparing a sort of data handbook for the use of ammunition designers, but the material was fragmentary and had not been published. The author makes no claim of originality. He has drawn freely on the foregoing source material and has augmented his borrowings with material gleaned from the experience and notebooks of his associates at Picatinny Arsenal. Personnel at Frankford, Raritan, and Edgewood Arsenals and the Office of the Chief of Ordnance have made valuable contributions of suggestions and material.

It is my belief that this book definitely fulfills the need envisaged by the author. His book will take its place alongside the other standard technical handbooks. It will not only serve as a basic and invaluable tool for the ordnance engineer but also should prove to be a convenient and definitive source of information for all those, military and civilian, whose work or interests carry them into the maze and complexity of modern ammunition.

MILES W. KRESGE
Colonel, Ordnance Department

PICATINNY ARSENAL
October 1945

PREFACE

Any textbook on ammunition must deal with at least three varieties of ammunition: the conventional older types in existence during World War I, of which small-arms and artillery ammunition are examples; the types developed between World Wars I and II, such as aircraft ammunition, improved types of small-arms, artillery, and pyrotechnic ammunition; and the types developed primarily during World War II, such as rocket ammunition and the many new varieties of all types of ammunition.

I consider this book an effort to reduce to writing my technical ammunition experience of the period 1940 to 1945, in the attempt to make available in one volume a book which the future beginner in ammunition design and development work can use in his efforts to become oriented in a most interesting and complex field. In writing this book I have tried to keep in my mind the beginner rather than the advanced and experienced ammunition man, so that an explanatory sentence here and there may serve to remove some mental barrier and pave the way for better understanding of the subject, or, at the very least, to better coordinate the parts. For example, the ammunition designer looks at military explosives from an entirely different viewpoint from that of the chemist, and the chapter on explosives may prove rather elementary to a chemist because not one chemical formula is mentioned. But it is hoped that the designer of a new ammunition component will be able to select the proper explosives to do a certain job after reading that chapter.

The chapter on rocket ammunition is merely an attempt to give the reader some picture of this new and fascinating subject. It is admitted that in a short time it will need revision.

Many phases of ammunition design are not covered because of security reasons.

My sincere appreciation is hereby given to all those engineers, chemists, and chemical engineers of the Technical Division at Picatinny Arsenal who have instructed me in the science of ammunition and corrected the manuscript. Space does not permit enumeration of all their names, but I owe a particular debt to Colonel Miles W. Kresge, for whom I have worked for the past three and one-half years, and who, in my opinion, has a grasp of this subject of ammunition most fundamental

and complete. Thanks are also due to Colonel L. C. Leonard, Major W. W. Carr, Lt. L. W. Hall, Dr. F. E. Myers, Dr. G. C. Hale, Mr. S. Feltman, Mr. W. L. Lukens, Mr. A. F. Teitscheid, Mr. J. M. King, Mr. D. R. Beeman, Mr. R. H. Wood, and Mr. M. H. Neumann for reviewing the manuscript. My assistant, Capt. C. R. Dean, Jr., has contributed much to this book both directly and by handling a great many routine matters while I gathered material for it. I wish also to express my appreciation to my Commanding Officer, Colonel W. E. Larned, to whose post I have been assigned for over four years. Miss A. Fogelson and Miss June Horning typed the manuscript. Raritan Arsenal furnished the many excellent illustrations.

The ideas and opinions expressed in this book are mine and do not necessarily express the attitude or views of any governmental agency.

If someone becomes interested in ammunition because of reading this book and thereby helps avert World War III by making American ammunition unexcelled, my efforts will have been rewarded.

THEODORE C. OHART

PICATINNY ARSENAL
October 1945

CONTENTS

PART I

EXPLOSIVES, PRIMERS, DETONATORS, AND TRACERS

ART.	CHAPTER 1. INTRODUCTION	PAGE
1.	What is Ordnance?	1
2.	What is Ammunition?	1
3.	General Types of Weapons	3
4.	Modern Relationships between Weapons	6
5.	General Types of Ammunition	6
6.	Nomenclature	10
7.	Specialized Words	12
8.	General Classifications of Ammunition	12
9.	Ammunition Lot Numbers	13
10.	Corrosion Prevention and Sealing	13
 CHAPTER 2. MILITARY EXPLOSIVES		
1.	General	16
2.	High and Low Explosives	17
3.	The Explosive Train	19
 <i>Propellants</i>		
4.	General Requirements	21
5.	Rate of Burning	21
6.	Single-Base Powder	25
7.	FNH and NH Powders	25
8.	Double-Base Powders	27
9.	Blending, Lot Numbers, and Loading Authorizations	28
 <i>Other Low Explosives</i>		
10.	Black Powder	28
11.	EC Blank Powder	30
12.	Nitrostarch Explosives	30
 <i>High Explosives</i>		
13.	General	30
14.	Important Properties of High Explosives	30
15.	General Classification of Important High Explosives	34
16.	Explosives Considered from Viewpoint of Application	35
17.	Summary of Properties of Important Explosives	38
18.	Compatibility of Explosives with Ammunition Materials	39

ART.	<i>The Shaped-Charge Effect</i>	PAGE
19.	General Description	41
20.	Factors Affecting Penetration	43
21.	Application	44

CHAPTER 3. PRIMERS, DETONATORS, AND TRACERS

1.	General Description	45
<i>Primers</i>		
2.	Description and Types	45
3.	Primer Mixtures	46
4.	Fuze Primers	46
5.	Artillery Primers	51
6.	Mortar Ammunition Primers	55
<i>Detonators</i>		
7.	Definition and Description	55
8.	Types	55
9.	Explosive Materials	56
10.	Properties and Testing	57
11.	Commercial-Type Squibs and Detonators	59
<i>Tracers</i>		
12.	General Description	60
13.	Projectile Tracers	61
14.	Fuze Tracers	63

PART II

SMALL-ARMS AMMUNITION

CHAPTER 4. SMALL-ARMS AMMUNITION

1.	General	64
2.	Caliber and Nomenclature	64
3.	Classifications of Small-Arms Ammunition	65
4.	Uses	66
5.	Hangfire	67
6.	Grades of Small-Arms Ammunition	68
7.	Inspections and Tests	69
8.	Ballistics and Stability.	71
9.	Bullet Design	73
<i>The Small-Arms Complete Round or Cartridge</i>		
10.	Components of the Cartridge	78
11.	Cartridge Marking	78
12.	The Cartridge Case	79
13.	Propellent Powder	80

ART.	<i>Base-Detonating Fuzes</i>	PAGE
13.	Uses	138
14.	Fuzes for 37-mm. HE Shell (M38, M58)	139
15.	Fuzes for Medium-Caliber AP Shell (M72, M66, M68)	140
16.	Fuzes for Medium-Caliber HEAT Projectiles (M62)	141
17.	Fuzes for Large-Caliber AP Projectiles (Mk X, M60)	142
<i>Point-Detonating Fuzes</i>		
18.	Uses	143
19.	General Point Fuzing Systems	144
20.	Small-Caliber Point Fuzes	
a.	Fuzes for 20-mm. Projectiles (Mk I, M75)	145
b.	Fuzes for 37-mm. Projectiles (M56, M74)	146
c.	Fuzes for 40-mm. Projectiles (No. 251, M64A1, M71, Mk 27)	147
d.	Fuzes for 57-mm. Projectiles	150
<i>Standard Interchangeable Point Fuzes</i>		
21.	General	150
22.	Impact Fuzes (M57, M48, M51, M78)	151
23.	Time Fuzes (M54, M43, M67, M55, M61)	155
<i>Mortar Fuzes</i>		
24.	Types and Uses	160
<i>Fuzes for 60- and 81-mm. Projectiles</i>		
25.	Fuzes for HE Projectiles (M52, M53, M77)	160
26.	Fuzes for Illuminating Projectiles (M65A1, M84)	163
<i>Heavier Mortar Fuzes</i>		
27.	Fuzes for Larger Mortars (M2, M3)	164
<i>Artillery Boosters</i>		
28.	General	165
29.	Description of Standard Boosters (M22, M20, M21, M24, M25)	166
30.	Fuzes for False-Ogive Projectiles (M51 Mod 3)	169
CHAPTER 7. ARTILLERY COMPLETE ROUNDS		
1.	General	171
2.	Components of the Complete Round	171
3.	Types of Complete Rounds	171
4.	General Requirements	174
5.	Nomenclature	174
6.	Painting and Marking Colors of Artillery Rounds	175
<i>Fixed Ammunition</i>		
7.	General	175
8.	Cartridge Cases	175
9.	Study of 37-mm. Fixed Rounds	176
10.	Study of 75-mm. Fixed Rounds	179

CONTENTS

xv

ART.	<i>Semifized Ammunition</i>	PAGE
11.	General	180
12.	Propelling Charges	181
13.	Ammunition for 75-mm. Howitzers	182
14.	Ammunition for 105-mm. Howitzers	182
 <i>Separate-Loaded Ammunition</i> 		
15.	General	184
16.	Types of Separate-Loaded Propelling Charges	184
17.	Propelling Charge for 155-mm. Howitzer M1	185
18.	Propelling Charge for 155-mm. Gun M1A1	187
19.	Propelling Charge for 14-in. Gun	189
20.	Propelling Charge for 240-mm. Howitzer	189
21.	The 120-mm. (4.7-in.) Complete Round	190
 <i>Mortar Complete Rounds</i> 		
22.	General	191
23.	Parts of Mortar Complete Rounds	192
24.	Functioning of Mortar Rounds	193

PART IV

AIRCRAFT AMMUNITION

CHAPTER 8. BOMBS

1.	General	195
2.	Bomb Ballistics	197
3.	Types of Bombing	200
4.	Bomb Detonation	202
5.	Impact Conditions and Penetration	203
6.	Bomb-Design Formulas	204
7.	Bomb-Design Tests	212
8.	Nomenclature	215
 <i>The Bomb Complete Round</i> 		
9.	Description	216
10.	Components of Bomb Complete Round	216
11.	Explosive Train	218
12.	Sizes and Capacities	220
13.	Painting and Marking of Bomb Complete Rounds	220
14.	Classifications	221
15.	Explosive Capacity	222
16.	Demolition and General-Purpose Bombs	222
17.	Light-Case Bombs	227
18.	Fragmentation Bombs	227
19.	Depth Bombs	231
20.	Armor-Piercing Bombs	232
21.	Semi-Armor-Piercing Bombs	232

ART.	PAGE
22. Chemical Bombs	234
23. Practice Bombs	239
24. Shaped-Charge Bombs	240
<i>Bomb Clusters</i>	
25. Purpose and Description	241
26. Construction	243
27. Cluster Data	247

CHAPTER 9. BOMB FUZES

1. General	248
2. Bomb-Fuze Explosive Train	249
3. General Construction of Bomb Fuzes	249
4. Bomb-Fuze Arming	251
5. Classifications of Bomb Fuzes	254

Nose Bomb Fuzes

6. General	256
7. Air Burst of Bombs	257
8. Nose Fuzes for GP Bombs (M103, M139, M140, M149, M127, M128, M135, M136)	258
9. Nose Fuzes for Fragmentation Bombs (M110, M104, M120, M129 series)	264
10. Nose Fuzes for Chemical, Smoke, and Practice Bombs, and Bomb Clusters (M108, M126, M111, M138, M145, M146, M144, M147)	268
11. Nose Fuzes for Depth Bombs (Mk 219)	271

Tail Bomb Fuzes

12. General	273
13. Primer Detonators	275
14. The AN-M100A2 Series	277
15. The M112A1 Series	279
16. The M115 Series	280
17. The M123A1 Series	280
18. The M132 Series	282
19. Mechanical Time Tail Fuzes (M152, M153)	283
20. The AN-Mk 228 Fuze	285
21. Tail Fuze for GP Parachute Bombs	285

Hydrostatic Bomb Fuzes

22. General	286
23. The AN-Mk 230 Fuze	286

PART V

PYROTECHNIC AMMUNITION

CHAPTER 10. PYROTECHNIC AMMUNITION

1. General	291
2. Classification of Pyrotechnics	292
3. Pyrotechnic Compositions	293

CONTENTS

ART.	PAGE
4. Pyrotechnic Ignition Train	296
5. Color Value	297
<i>Ground Pyrotechnics</i>	
6. General	298
7. Ground Signals	298
8. Ground Illuminants	301
<i>Aircraft Pyrotechnics</i>	
9. General	308
10. Aircraft Signals	308
11. Aircraft Illuminants	315
12. Phetoflash Bombs	318
<i>Miscellaneous Pyrotechnics</i>	
13. Distress Signals	320
14. Marine Marker	321
15. Insecticide Mortar	321
16. Pathfinder Pyrotechnics	321

PART VI

ROCKET AMMUNITION

CHAPTER 11. ROCKETS

1. Introduction	326
<i>Fundamental Considerations</i>	
2. Formation of the Jet	327
3. Thrust	327
4. Propellant Powder	328
5. Efficiency	330
6. Stability and Accuracy	331
7. Classifications of Rockets	332
<i>Rocket Components</i>	
8. General	332
9. Description of Typical HE Rocket	333
10. Rocket Fuzes (M400, M4A2, M81, Mk 137, Mk 146)	334
11. Rocket Igniters	340
12. Rocket Motors	341
<i>Descriptions of Typical Rockets</i>	
13. 2.36-in. Rockets (M6, M7, M10)	341
14. 3.25-in. Antiaircraft Target Rocket (M2)	343
15. 3.5- and 5-in. Rockets	344
16. 4.5-in. Rockets (M8, M9, M16, M20, M21)	345
17. 7.2-in. and Larger Rockets	348

ART.	<i>Rocket Launchers</i>	PAGE
18.	General	349
19.	Descriptions of Important Launchers	350
20.	Advantages and Disadvantages of Rockets	352

PART VII

MISCELLANEOUS AMMUNITION

CHAPTER 12. MISCELLANEOUS AMMUNITION

1.	General	354
	<i>Grenades</i>	
2.	Description and Uses	354
3.	Classification of Grenades	355
4.	Grenade Fuzes (M6, M10, M200, M204, M205)	356
5.	Hand Grenades (Mk I, Mk II, Mk III, M6, M8, M14, M15, M21)	358
6.	Rifle Grenades (M9, M11, M17, M19)	360
	<i>Mines</i>	
7.	Description and Uses	363
8.	Antitank Mines (M1, M4, M5, M6, M7)	364
9.	Antipersonnel Mines (M2, M3)	367
	<i>Destructors and Miscellaneous Ammunition</i>	
10.	Destructors (M1, M2, M3, M4, M5, M6, M7)	370
11.	The M1 Bullet Impact Fuze	374
12.	Demolition Devices	375

PART VIII

AMMUNITION PACKING

CHAPTER 13. AMMUNITION PACKING

1.	Purpose and Necessity	377
2.	Requirements of Satisfactory Packing	377
3.	Laboratory Tests	380
4.	Wood Boxes	382
5.	Palletized Packing	382
6.	Overseas Packing	384
	<i>Artillery-Ammunition Packing</i>	
7.	General	387
8.	Metal-Container Program	389
9.	Fixed and Semifixed Round Packing	391
10.	Separate-Loaded-Ammunition Packing	392

CONTENTS

xix

ART.	<i>Aircraft-Ammunition Packing</i>	PAGE
11.	General	393
12.	Bombs over 100 Lb.	393
13.	100-Lb. Bombs	394
14.	Bombs under 100 Lb.	394
15.	Clusters	394
16.	Small-Arms Packing	396
17.	Miscellaneous Ammunition Packing	396
INDEX	399

PART I

*EXPLOSIVES, PRIMERS, DETONATORS, AND
TRACERS*

CHAPTER 1

INTRODUCTION

1. What is Ordnance?

Strictly speaking, **ORDNANCE** is everything for which the Chief of Ordnance is responsible. Before World War I, ordnance was popularly supposed to mean guns and ammunition, though even then it actually included much more. During World War I the Ordnance Department was responsible for all types of artillery, self-propelled mounts, fire-control apparatus, instruments, small arms, and ammunition of all types. Between World War I and World War II, and during World War II, tanks, motor combat and transport vehicles, rockets and rocket ammunition, as well as many new varieties of the previous categories, have been added to the Ordnance Department. We may therefore say that ordnance is everything the army fights with, except certain specialized equipment for the Air Force, principally aircraft.

By being "responsible" for these items, we mean that the Ordnance Department is responsible for the design, development, procurement, manufacture, inspection, acceptance, packing, shipment, storage, issue, and maintenance of these items. And the actual items involved today, which collectively we may say constitute ordnance, are tanks, tank destroyers, artillery and ammunition, self-propelled mounts, carriages and recoil mechanisms, fire-control apparatus and instruments, motor combat and transport vehicles (trucks, half-tracks, high-speed tractors, armored cars, scout cars, command cars, jeeps, peeps, amphibious vehicles, etc.), small arms and ammunition, rocket launchers and rockets, bombs, pyrotechnics, grenades, mines, machine tools, certain raw materials, explosives, and spare parts for all this equipment.

2. What is Ammunition?

To the civilian whose contact with ammunition consists of shooting a rifle or shotgun several times in the fall during the hunting season, the word "ammunition" connotes either a slug of metal attached to a

cartridge case containing powder, or a series of balls if he happens to be shooting a shotgun. That would be like saying that a shoelace is an article of clothing—a true statement, but hardly one that describes the clothing industry.

AMMUNITION is any material used in attack or defense in warfare intended to inflict damage upon the enemy. It consists of artillery, aircraft, rocket, small-arms, and miscellaneous ammunition. Regardless of the type, it is used to destroy personnel, fortifications, structures, ships, aircraft, ammunition dumps, or any military objective. It is important to remember this, because the purpose for which the ammunition is intended affects its design. An artillery shell may be a solid shot of specially heat-treated alloy steel, or a comparatively thin-walled shell containing high explosive and fitted with an intricate time fuze, depending upon whether we want to pierce a tank or shoot down a plane. A bomb might be a heavy-walled 20-lb. steel container filled with explosive and fitted with a parachute to decrease its rate of fall, and functioned by a very sensitive fuze in order to obtain fragmentation against a column of troops, or it might be a stupendous thin-walled 5-ton "tin can" filled with explosive to blast buildings and fortifications. A mortar shell might be a 2½-lb. high-explosive shell effective at ranges up to 300 yd., or it might be a 100-lb. shell fired at long ranges in place of a howitzer shell because the mortar can be set up in position on newly won ground so much quicker. Yes, it is the result to be accomplished that determines the design. From the customer-designer-manufacturer standpoint, it is the customer that must be satisfied, whether the customer of the Ordnance Department be the Air Forces, the Marines, the Ground Forces, the Navy, or even the recipients of Lend-Lease, because tremendous quantities of ammunition have been shipped to our allies through that medium.

Reduced to its fundamentals, ammunition consists of metals plus explosives. Almost all ammunition components contain explosives, and it is the disruptive force of these explosives that makes ammunition effective. With the exception of solid armor-piercing shot and small-arms bullets, ammunition consists of appropriate explosives in suitable metal components. It follows that the two most important industries from the ammunition standpoint are the explosives industry and the metals industry.

Ammunition, like all ordnance, is cumulative. By that we mean that very few items are completely replaced by newly developed items, but rather we continue to have some use for the old item, and the new one is an addition to our ammunition repertory. We still fight with knives, bayonets, rifles, and grenades, despite the development of automatic

rifles, specialized mortars, and machine guns. We merely added the last group to the first, and use and fight with all of them. Rockets and bombs supplement but do not replace artillery and its ammunition. Hollow-charge armor-piercing projectiles supplement but do not replace solid-shot armor-piercing projectiles. And so it is with all ammunition—we have *just about everything we had before World War II plus all the items developed during World War II*, so that the study of ammunition grows increasingly complex. It is no longer a small matter, but *well-nigh the most important matter for an army to consider*—the kinds and types and efficiency and availability of its AMMUNITION.

3. General Types of Weapons.

A WEAPON is a device for inflicting damage upon the enemy, and this purpose is accomplished by projecting missiles (ammunition) from the weapon. To understand the different types of weapons, we will first discuss them from the older and customary viewpoint.

A CANNON is any large weapon too heavy to be carried by hand. Guns, howitzers, and mortars (except trench mortars) are types of cannon. A RIFLE is any weapon which has rifling in the barrel in order to impart a twist to the projectile to achieve stability. Although used to denote the small-arms types of rifle in particular, the term rifle can correctly be applied to rifled artillery guns as well.

Small Arms. SMALL ARMS are weapons 0.60 in. or under in caliber used primarily by the infantry, and usually operated and carried by one or two men. This category includes rifles, semi-automatic rifles, automatic rifles, pistols, carbines, machine guns, submachine guns, etc. They will not be discussed further in this treatise, but ammunition for them is discussed in Part II.

Guns. GUNS have long been considered long-range, high-velocity, high-pressure weapons fired at low elevations, say under 20°. Because of these characteristics they are the heaviest type of cannon and are not particularly mobile. Table 1 shows three types of 37-mm. guns, with entirely different characteristics, depending upon the tactical requirement. The old field gun used in World War I was a light gun (56 lb.) firing a small high-explosive shell (1.2 lb.) at short ranges and at targets which could usually be seen through field glasses, so that a muzzle velocity of 1100 ft./sec. at a chamber pressure of 18,500 lb./sq. in. was quite satisfactory. It was the low pressure that resulted in light-weight parts and extreme mobility.

Now when the requirement for a 37-mm. antiaircraft gun arose with a range of about 5 miles in the air, a much higher muzzle velocity was needed, which meant a higher chamber pressure (30,000 lb./sq. in.) and

stronger, heavier parts. A gun weighing 370 lb. resulted, and its comparative immobility was consistent with its purpose—a more or less fixed defense against aircraft.

TABLE 1
COMPARISON OF 37-MM. GUNS

Type	Maximum Muzzle Velocity ft./sec.	Maximum Chamber Pressure lb./sq. in.	Maximum Range	Type of Target	Weight (without Carriage) lb.
1916 field gun	1100	18,500	Short	Machine-gun nests, pill boxes, light ground targets, antipersonnel	56
Antiaircraft gun	2600	30,000	8800 yd.	Aircraft	370
Antitank gun	2900	50,000	8800 yd.	Tanks and armor	225

Still another 37-mm. gun was required to defeat the tank, the essential characteristic being a maximum muzzle velocity in order to penetrate the maximum thickness of armor. Yet an antitank gun must have some mobility in order to be effective against mobile tanks in mechanized warfare. Therefore a gun was developed having 2900 ft./sec. as a velocity, and despite its pressure of 50,000 lb./sq. in. the gun weighed only 225 lb.

The accuracy of a gun is due primarily to its rifled bore and high muzzle velocity, which means high chamber pressure. Let us see how these features are varied in the howitzer to achieve mobility.

Howitzers. A HOWITZER is a shorter, lighter-weight weapon, fired at higher elevations, resulting in shorter range, and at targets which cannot be reached by direct fire. Therefore, a howitzer is a lighter-weight, more mobile weapon. Table 2 contrasts a 75-mm. gun and howitzer.

TABLE 2
COMPARISON OF 75-MM. GUN AND HOWITZER

Type	Muzzle Velocity ft./sec.	Chamber Pressure lb./sq. in.	Maximum Range yd.	Length calibers	Weight (without Carriage) lb.
75-mm. gun	1950	36,000	13,500	34.5	1250
75-mm. howitzer	700-1250	29,000	4000-9000	15.9	656

Thus, in order to obtain a more mobile weapon weighing half as much as a gun of the same caliber, we have sacrificed almost half the

range (because of decreased muzzle velocity), with less chamber pressure resulting in lighter-weight parts, but we have also gained in flexibility because the howitzer can be fired at any elevation up to 65° . In spite of its rifling, a howitzer is less accurate than a gun because of its lower muzzle velocity. Figure 1 compares gun and howitzer trajectories.

Mortars. MORTARS are weapons that are even shorter, lighter, and more mobile than howitzers. The muzzle velocity and chamber pressure are less and the angle of fire greater, particularly for trench mortars, which are of the smooth-bore variety. Some of the larger mortars are rifled. Trench mortars are used against troops in trenches and foxholes, machine-gun nests, and obstructions and barriers, and they are adapted to plunging fire at high angles, even up to 85° . They are excellent for firing over local obstructions and hills, preparatory to infantry advance. Table 3 gives the characteristics of some common mortars, and Fig. 1 shows a mortar trajectory compared to gun and howitzer trajectories.

TABLE 3
CHARACTERISTICS OF MORTARS

Type	Maximum Muzzle Velocity ft./sec.	Maximum Chamber Pressure lb./sq. in.	Maximum Range	Weight lb.
60-mm. TRENCH MORTAR (SMOOTH-BORE)	500	6000	2000 yd. at 45°	13
81-mm. TRENCH MORTAR (SMOOTH-BORE)	700	6000	3200 yd. at 45°	45
4.2-in. CHEMICAL MORTAR (RIFLED-BORE)	1000	9000	3200 yd.	300

Rocket Launchers. With the advent of rockets, a new type of weapon known as a ROCKET LAUNCHER was developed. Since the various types of rocket ammunition (or just rockets, as they are called) are complete in themselves, carrying their own propellant powder and requiring only an ignition device and initial guidance, rocket launchers are either guide rails or guide tubes fitted with some electric ignition device. Typical launchers of both types are shown in Figs. 199 and 200. The muzzle or launching velocity is lower than that of artillery, the ranges are less, but mobility is a maximum, as projectiles of artillery caliber can be projected at the enemy from front-line positions from launchers carried upon the back of a man. But, as we shall see in our discussion of rockets, mobility is achieved at the expense of accuracy. A rocket trajectory compared to mortar, gun, and howitzer trajectories is shown in Fig. 1.

4. Modern Relationships between Weapons.

Some of the differences between guns, howitzers, mortars, and rocket launchers as discussed in Art. 3 are summarized in Fig. 1, according to the trajectories shown. Modern weapons more or less minimize these differences of range, velocity, pressure, and angle of fire, but the main differences of WEIGHT and MOBILITY remain. The old definition of a gun being fired at low angles of elevation no longer applies, because antiaircraft guns can be elevated up to 90°. Many howitzers have ranges at full charge approaching those of guns of the same caliber. The modern World War II 240-mm. howitzer has a range exceeding that

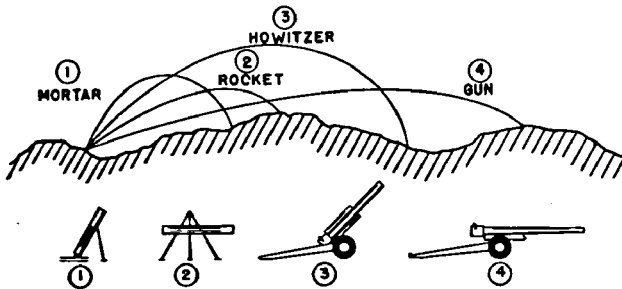

FIG. 1. Comparison of trajectories.

of the M1918 gun but of course is a heavier weapon. The 4.2-in. chemical mortar is rifled like a gun and fires a high-explosive shell weighing 24.6 lb. at a velocity as high as 600 ft./sec. Thus it is seen that the velocities, ranges, and weights of guns, howitzers, and mortars overlap, but the general distinction is based on weight and mobility: the gun is the heaviest and least mobile, the howitzer somewhat lighter and more mobile, the mortar the lightest and most mobile. Rocket launchers are not even in this class, weighing only a few pounds.

5. General Types of Ammunition.

Small-Arms Ammunition. The word "bullet" is associated with small-arms ammunition, and we think of a bullet as a lead slug. Actually, small-arms bullets are used in a variety of forms, including ball (lead core in gilding metal jacket), armor-piercing (steel core in jacket), tracer (like ball except for tracer composition in rear half), incendiary (incendiary inside steel core with jacket), guard (ball with reduced propelling charge), and high-pressure test (ball with excess propelling charge). Small-arms ammunition also includes blank, rifle-grenade, and subcaliber ammunition, and shotgun shell. The complete round of small-arms ammunition is called a CARTRIDGE.

Artillery Ammunition. All the components required to fire a gun once are called collectively a COMPLETE ROUND, whether they are physically attached as a unit or not. The complete round is the ultimate objective in artillery ammunition design and manufacture, and unless the complete round is satisfactory as such (regardless of how well designed and made certain parts may be) the artilleryman has nothing to fire against the enemy.

Artillery ammunition is classified as follows:

1. According to service use.

SERVICE AMMUNITION, to inflict damage upon the enemy.

TARGET OR PRACTICE AMMUNITION, for training troops in actual firing.

DRILL AMMUNITION, for training gun crews in going through the operations of gun firing without actual firing.

BLANK AMMUNITION, for saluting purposes.

2. According to tactical use.

HIGH-EXPLOSIVE, containing a high explosive for bursting a shell for fragmentation or blast effect.

ARMOR-PIERCING, for penetrating armor, such as tank armor.

CHEMICAL, containing chemicals used in chemical warfare.

SMOKE, a variety of chemical shell containing smoke mixture for laying down a smoke screen, or spotting bursts, or against personnel.

ILLUMINATING, for illumination of the enemy or enemy territory at night to disclose movements.

CANISTER, lead or steel balls in a matrix within a can-type container for use against personnel or to clear dense undergrowth in jungle warfare.

SPECIAL, for some special purpose, such as a shell to distribute propaganda leaflets or to propel a grappling hook.

3. According to method of containing the propellant powder.

FIXED, propellant powder contained in a cartridge case permanently attached to the projectile.

SEMIFIXED, propellant powder contained in bags in a cartridge case not permanently attached to projectile, but removable in the field so that the charge may be adjusted.

SEPARATE-LOADED, propellant powder contained in bags which are loaded separately into the breech of the gun behind the projectile.

Aircraft Ammunition. BOMBS and certain pyrotechnics are collectively called aircraft ammunition, which includes anything dropped out of a plane. The BOMB COMPLETE ROUND consists of all the components necessary to drop and function a bomb. PYROTECHNICS are usually considered aircraft ammunition, though some pyrotechnics are used by the ground forces. Bombs may be classified as follows:

1. According to service use.

SERVICE BOMBS, to inflict damage upon the enemy.

PRACTICE BOMBS, for training bombing crews in actual practice, and usually containing a spotting charge.

DRILL BOMBS, for training ground crews in handling, fuzing, and assembling bombs; they are totally inert.

2. According to tactical use.

GENERAL-PURPOSE, containing high explosives, sometimes called **DEMOLITION BOMBS**, and used for general demolition, blast effect, or mining effect.

FRAGMENTATION, combining a fragment-producing container with high explosive, for use against personnel, light ground targets, etc.

CHEMICAL, containing chemicals used in chemical warfare.

SMOKE, a variety of chemical bomb containing smoke mixture for laying down a smoke screen.

ARMOR-PIERCING, for penetrating armor, such as ship side and deck armor, etc.

SEMI-ARMOR-PIERCING, for penetrating lighter armor, concrete, and other resistant targets.

INCENDIARY, containing an incendiary mixture for instituting conflagrations.

DEPTH, for detonating under water against the side of a ship or submarine.

LIGHT-CASE, containing a high percentage of explosive in a light case, primarily for blast effect.

Pyrotechnic ammunition is classified as follows:

1. According to tactical use.

GROUND, devices fired from or used on the ground.

AIRCRAFT, devices released from aircraft.

2. According to type of functioning.

SIGNALS, to be seen by night or day to convey a particular meaning.

ILLUMINANTS, light sources to provide illumination over an area.

3. According to the type of the component.

FLARES, burning candles.

BOMBS, bombs filled with illuminant or smoke material.

SHELL, projectiles containing pyrotechnic compositions.

GRENADES, grenades containing pyrotechnic compositions.

CARTRIDGES, containing pyrotechnic compositions.

4. According to method of projection.

AIRCRAFT TYPES, dropped from aircraft.

PROJECTOR TYPES, fired from a pyrotechnic projector.

PISTOL TYPES, fired from a pyrotechnic pistol.

RIFLE TYPES, fired from a rifle grenade adapter.

HAND TYPES, fired by holding in the hand.

MORTAR TYPES, fired from a trench mortar.

5. According to speed of descent.

FREELY FALLING, without parachute to decrease speed of descent.

PARACHUTE, with parachute to decrease speed of descent.

Rocket Ammunition. Since rockets are really artillery projectiles carrying their own cartridge case and propellant powder with them, they are classified similarly to artillery ammunition, except that the distinction between fixed, semifixed, and separate-loaded ammunition does not exist.

Rocket ammunition is classified as follows:

1. According to service use.

SERVICE AMMUNITION, to inflict damage upon the enemy.

PRACTICE AMMUNITION, for training troops in the operation of rockets and rocket launchers and in marksmanship.

DRILL AMMUNITION, for training troops in the operation of rockets.

2. According to tactical use.

HIGH-EXPLOSIVE, containing a high explosive for fragmentation and blast effect.

ARMOR-PIERCING, for penetration of armor, concrete, and other resistant targets.

CHEMICAL, containing chemicals for chemical warfare.

SMOKE, a variety of chemical rocket for screening and antipersonnel effect.

3. According to the method of stabilization.

FIN-STABILIZED ROCKETS, using fins for stabilization.

SPIN-STABILIZED ROCKETS, using rotation for stabilization.

Miscellaneous Ammunition. Ammunition not strictly classified as small-arms, artillery, aircraft, or rocket ammunition will be classified here, the main types being:

1. MINES.

ANTITANK, for use against tanks, trucks, armored vehicles, etc.

ANTIPERSONNEL, for use against personnel.

BEACH DEFENSE, for use against landing craft, particularly small landing craft carrying personnel.

(Mines are also classified as metallic and non-metallic.)

2. GRENADES.

OFFENSIVE, for use in attack and so designed that their functioning does not impede advance of the attacker.

FRAGMENTATION, for use where cover must be taken by the thrower.

(Grenades are also classified according to the filler, as high explosive, chemical, smoke, incendiary, etc.)

3. DESTRUCTORS.

These devices are similar to Engineer Corps demolition devices, being equipped with demolition explosives, but the controlling equipment is

usually more complicated, inasmuch as the device must not function until certain conditions are fulfilled. Destructors may be classified as:

Destructors for radio equipment.

Destructors for control equipment.

4. MISCELLANEOUS.

This group includes any ammunition component or device not classified above.

6. Nomenclature.

Because of the many sizes and types of present-day ammunition it is essential that we have some system of nomenclature which allows us to describe the individual types and to differentiate between them. The nomenclature of artillery ammunition is most complex because we adopted weapons and ammunition from the French, and the French metric system is still used to denote many sizes and types. Still other sizes and types of ammunition are specified by the English system, particularly large-caliber seacoast ammunition from 6 to 16 in. which we had developed before World War I on a strictly defense basis. Then World War I found us fighting an offensive war requiring trench mortars and regimental size and type weapons and ammunition, and so we adopted the 81-mm. mortar, the 37-, 75-, and 155-mm. guns, and the French-type grenade. Since then we have added other weapons, some expressed in millimeters and some in inches. With either type of measurement, however, it has always been the CALIBER, or diameter of the bore, that has been the distinguishing characteristic of artillery ammunition.

Aircraft ammunition, developed almost entirely since World War I, has always been characterized by WEIGHT instead of caliber or size, because weight is the controlling factor of an airplane's capacity. Thus, we have bombs from 4 lb. to 4000 lb. in weight. Pyrotechnics have always been identified by name—the bombardment flare, the red-green double-star aircraft signal, etc.—except photoflash bombs which are identified by weight.

Rocket ammunition, being similar to artillery ammunition, is also identified by caliber, but since it is a recent development the English system has been applied almost exclusively.

Mines, grenades, destructors, and miscellaneous ammunition are identified by name: *non-metallic antitank mines, radio-beacon destructor, etc.*

Small-arms ammunition is identified by caliber, expressed in the English system in decimals of an inch. Thus, a caliber .30 rifle cartridge bullet is 0.30 in. in diameter.

Regardless of the system—diameter, weight, name—it is desirable to assign arbitrary numbers or nomenclature to all ammunition, and such a system has long been used by the Ordnance Department. Before World War I the number of models of any ordnance item was so small that a standardized model was identified by the year, with or without the letter “M” as a prefix, different models sometimes being denoted by a suffix: the 1895 10-in. seacoast gun, the M1897 75-mm. field gun, the M1905A2 6-in. gun, etc. During World War I and up to 1925, this system was supplemented by the “Mark” system, particularly as applied to ammunition, suffixes being added to denote model variations, such as the Mk III 155-mm. HE shell, the Mk IIA1 155-mm. chemical shell, and the Mk 33 1000-lb. AP bomb. Since 1925 all newly developed ordnance items, including ammunition, have been assigned “T” numbers during their development and “M” numbers after standardization by action of the Ordnance Committee, with appropriate suffixes. Regardless of the nomenclature system used, each caliber or weight carries its own series of numbers; that is, we could have an M1 75-mm. shell, an M1 105-mm. shell, and M1 500-lb. bomb, etc., but the phrase “M1 75-mm. shell” is definitive, as it specifies one particular shell, whereas the phrase “M1 shell” would not.

The present system is as follows:

T number, assigned to an experimental item in process of development, and not standardized.

M number, assigned to an item standardized by action of the Ordnance Committee.

Mk number, standardized Navy item, or old Army item.

E suffix, denotes an experimental variation of either an experimental or standard item.

A suffix, denotes a standardized variation of a standard item, usually in design other than material (not applied to T numbers because an experimental variation of an original experimental design would simply be given an M number upon standardization).

B suffix, denotes a standardized variation of a standard item, usually method of manufacture or material.

AN prefix, denotes a standardized item, standard for use by both Army and Navy.

The following hypothetical example will clarify this method of assigning nomenclature:

T28, nomenclature assigned to a point-detonating superquick fuze for the 60- and 81-mm. mortars during development.

T28E1, a redesign of the same fuze for the same purpose to strengthen certain parts, facilitate arming, etc.

M52, nomenclature assigned to the T28E1 fuze upon standardization.

M52E1, a modification of the standard fuze to permit its use in the 105-mm. mortar.

M52B1, standardized variation of the M52, with the standard 3-part aluminum fuze replaced by the same 3 parts (body, booster cup, head) made from plastic material.

M52A1, the M52 fuze with aluminum head replaced by zinc die-cast head to improve stability by increasing the weight of the nose.

M52B1E1, same as M52B1, except 1-piece plastic instead of 3-piece plastic.

M52B1E2, same as M52B1, except booster cup replaced by a burster tube for chemical shell.

M52A1B1, same as M52A1 except plastic instead of aluminum parts or same as M52B1 except zinc die-cast head instead of plastic.

Needless to say, the number of T numbers assigned far exceeds the number of M numbers, because various designs have to be attempted to produce a satisfactory one worthy of standardization. Furthermore, the demand by the Using Services for certain items has resulted in their being put into production before the routine of standardization could be accomplished, so that some T items are actually in production.

7. Specialized Words.

Certain words have been used for many years in ordnance, and have taken on specialized meanings which have become accepted in ordnance circles. Thus, the word *MATÉRIEL* denotes more or less finished Ordnance items ready to use, as opposed to *MATERIAL*, which is understood to be unfinished items or the actual materials from which items are made. Guns, planes, ammunition, and tanks are *matériel*. Steel, copper, plastics, fuze parts, and gun parts are *materials*. Another popular word is *FUZE*, which means a detonating-type fuze on a piece of ordnance ammunition, as opposed to *FUSE*, which refers to miner's fuse, or slow-burning fuse. The word *PRIMER* is somewhat ambiguous as used in ammunition, and the phrase *ARTILLERY PRIMER* has come to mean the long cartridge-case primer with percussion primer element and black powder-igniting charge, while the word *primer* alone usually means a small-arms or artillery fuze type primer with a priming mixture alone. These terms are sometimes interchanged, and the word *primer* should not be used alone without clarification. In fact, it is essential that ammunition components be expressed in precise language, free from ambiguities, and in this text we shall attempt to do exactly that.

8. General Classifications of Ammunition.

All ammunition is classified as standard, substitute standard, or limited standard, depending upon the status of its design, its availability

for issue and use, and the general situation with regard to the particular type of ammunition in question. Ammunition is classified as **STANDARD** when it is of an advanced and satisfactory design in common use or intended for regular procurement if needed. Ammunition which is quite usable but not of the most satisfactory design, and which would not be used if standard ammunition were available in large quantities, is called **SUBSTITUTE STANDARD**. It is not available for issue in the broad sense of the word. Ammunition is classified as **LIMITED STANDARD** if it is usable but is not of the most satisfactory design. It may be in use with the intent to withdraw it when a more satisfactory design becomes available. Substitute standard ammunition is usually a design based on substitute materials or manufacturing methods, whereas limited standard ammunition is usually an older type once standard being used only until the supply is exhausted.

The M38 BD artillery fuze is limited standard, having been replaced by the M58 BD fuze, although the former will be used as long as older-design shell require it. The M104 bomb fuze is substitute standard, as it is interchangeable with the newer M120-type fuze.

9. Ammunition Lot Numbers.

An **AMMUNITION LOT NUMBER** is a number assigned to a quantity of ammunition items or ammunition components that have been manufactured under conditions as nearly identical as possible and that may be expected to function uniformly. It consists of loader's lot number, symbol, or initials, and date loaded. The lot number establishes the identity of the ammunition and is of value to the designer, particularly from the standpoint of investigation of malfunctioning or accidents. When an undesirable condition is discovered, the existence of lot numbers allows certain ammunition to be recalled from the field, suspended, or destroyed because the lot number is tied up to all the data and the manufacturing history of the lot by means of the **DATA CARD**, on which all such information is carefully recorded at the time of manufacture. A copy of the data card is forwarded with each shipment, and it ties up the final lot number with the lot numbers of all the components from which the ammunition was assembled and loaded, together with the drawing numbers and any variations from the drawings.

10. Corrosion Prevention and Sealing.

In addition to proper packing to protect ammunition components, some type of treatment is given many components, like painting, plating, or other surface treatment. Before such treatment is given, it is essential that the surfaces to be treated are clean, so that any residues

such as perspiration from handling, residual fluxes, cutting or cooling compounds, or metallic particles are absent. The usual rust preventative and lubricating oil preservation compounds are not used on ammunition components because they might prevent proper functioning, and because ammunition components contain many inaccessible cavities from which these materials could not easily be removed. The common surface treatments may be classified as plating, dipping, and coating.

Plating. Aluminum, copper, and brass parts are usually not plated. Fuze, booster, and small parts of steel are usually plated with zinc or cadmium, and they may be dipped as well. Plating is intended to withstand a 24-hour salt spray test. It is important that the plating be properly applied, as poor plating results in rust and corrosion in a comparatively short period of storage, depending on the conditions of storage and packing. Ammunition may be stored for 20 years before use.

Dipping. Various chromate dippings have been used, especially when plating is first applied. Solutions known as "Cronak," "Irridite," and "yellow ano-zinc" are used. The usual requirement is that the 24-hour salt spray test must be met. These dipping solutions may be applied to the same types of parts as are plated.

Coating. A common type of coating is paint. The outside of larger components such as shell, bombs, rockets, and mines are painted for protection as well as identification. The inside of shell and bombs are coated with acidproof black paint, an asphaltic petroleum derivative, which not only protects the cavities from corrosion but also prevents reactions between explosives and metals. Acidproof black paint is also used as a waterproofing agent.

Certain small components like detonator cups are coated with lacquer to prevent corrosion and reaction between explosives and metals. A Bakelite varnish is used to coat long cavities such as burster casings. NRC Compound is a waterproofing lacquer consisting of nitrocellulose and certain resins in a suitable solvent; it is used to coat threads, seal detonator discs, primers, and many small parts and joints. Pettman cement is a water-repellent adhesive cement consisting of alcohol, pine tar, shellac, and iron oxide; it is used as a fastener to secure both threaded and unthreaded parts, such as booster cups and joints. It differs from the other coatings mentioned in that it "sets up," becoming hard and making a good joint. Shellac is used to coat cavities to be loaded with black powder, such as delay element cavities and time train ring grooves.

Acidproof black paint is not suitable for coating cavities which are to contain chemical fillings because of the reaction between the chemicals and the paint. At present, a light lubricating oil of 100% hydrocarbons

is used to flush out the cavities. Rust is particularly bad for non-persistent fillers, and for this reason special coatings such as baked varnish or lacquer are applied, no one coating being satisfactory for all fillings.

The seemingly unimportant problem of proper surface treatment and sealing is just as important to the ammunition designer as the actual component design.

CHAPTER 2

MILITARY EXPLOSIVES

1. General.

Reduced to barest essentials, ammunition consists of METALS plus EXPLOSIVES. The general purpose of ammunition is to blow things up, to demolish structures, to kill people by exploding fragments or blast effect. To accomplish this purpose we employ explosives, and since they must be contained in some type of component to carry them to the desired point and control the explosion, metals are used. Thus, the ammunition business is really the chemical business plus the metal-working and machine-tool business. In this chapter we shall consider the explosive half of ammunition from the point of view of the ammunition designer rather than that of the chemist. The chemistry of explosives forms the basis of many well-known treatises.

We may define an EXPLOSIVE as a substance that rapidly changes from its initial state (usually but not necessarily a solid) to a gaseous state by the application of heat, friction, a blow, or some other means, the change being accompanied by the evolution of heat. This definition considers the explosive apart from any surrounding medium and makes no reference to effects on the medium. The volume of gaseous products is many times the original volume. Note that three essential requirements must be met: the transformation must be rapid; the transformation must be initiated by heat, flame, spark, friction, shock, or some other suitable method; and there must be evolution of heat.

If a solution of sodium chloride is mixed with a solution of silver nitrate, a milky white precipitate will be formed instantly. The silver chloride is formed so fast that its speed of formation cannot be measured by known means, and little heat is produced. Such a mixture of solutions is not classed as an explosive, because, even though the reaction is rapid, the other requirements for explosives are not fulfilled. A mixture of nitrogen and oxygen gases reacts rapidly upon application of heat to give the gaseous product nitric oxide. Although the reaction is rapid, the mixture is not classed as an explosive because heat is not evolved; in fact, there is a reduction in temperature and pressure during the reaction. But, if a quantity of TNT is initiated by the shock wave

from an initiator, a very rapid reaction takes place, with the formation of gaseous products and the evolution of heat, and so TNT is a true explosive.

Not all explosives are suitable for military work. Dynamite has been used for years in the industrial and construction fields but is not suitable as a MILITARY EXPLOSIVE. The common explosive TNT, on the other hand, is ideally suited as a military explosive, particularly for ammunition; we shall understand why this is so as we study high explosives.

2. High and Low Explosives.

Military explosives are classified into two main categories:

HIGH EXPLOSIVES, which are usually initiated by shock or a blow, have a very high rate of reaction, and a high disruptive effect on the surrounding medium.

LOW EXPLOSIVES, which are usually initiated by flame or a spark, have a comparatively lower rate of reaction and have a comparatively less disruptive effect on the surrounding medium.

The comparatively fast reaction of a high explosive is called **DETONATION**, and the slower reaction of low explosives is called **DEFLAGRATION** or **BURNING**. In other words, high explosives detonate and low explosives burn, so that high explosives are ideally suitable as shell and bomb fillers in order to give the maximum demolition effect at the target, and low explosives are ideally suitable as propellant powders to expel projectiles from weapons. A high explosive would blow up the weapon, because of its high reaction rate and because of its shattering effect, whereas a low explosive would be ineffective in reducing concrete fortifications or in obtaining proper shell fragmentation. TNT and other high explosives make excellent shell fillers, and smokeless powder makes an excellent low explosive in the form of a **PROPELLANT**. Not all substances fall definitely into the classifications of high and low explosives. Black powder burning in the form of a time train, or a delay element, is a low explosive; but when confined and properly initiated it may explode although it is not a true high explosive. The high-explosive initiators like mercury fulminate and lead azide are commonly classed as high explosives, but they may be initiated by flame or spark, a method of initiation usually associated with low explosives.

It is worth while to examine more closely on a qualitative basis this difference between the detonation of a high explosive and deflagration or burning of a low explosive. Consider a portion of high explosive, initiated at one end as shown in Fig. 2(a). The material is consumed by the rapid physicochemical transformation as the detonating wave travels away from the point of initiation. The products of the detonation (usu-

ally gases) also travel in the same direction, so that there is a tendency to create a low-pressure area behind the wave as well as the high pressure established by the wave itself. This accounts for the fact that when large quantities of high explosives are detonated, such as are contained in "blockbusters," the low pressure created may do as much damage as the direct blast effect, and windows may break outwards towards the detonation outside of a dwelling. The speed of this detonating wave is called the **RATE OF DETONATION**; it varies from 3000 to 8000 meters/sec. The rate of detonation of a high explosive is one of its important properties and partly determines its application. Ordinary cast TNT has a rate of detonation of about 7000 meters/sec., or over 21,000 ft./sec.,

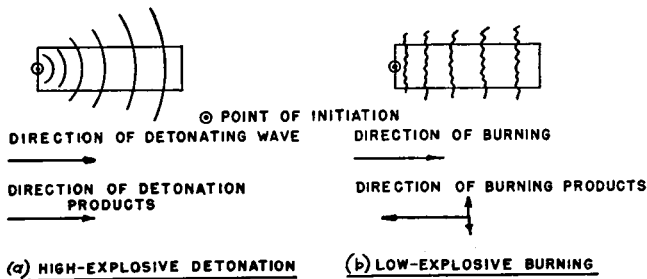

FIG. 2. Diagram of detonation vs. burning for high and low explosives.

many times faster than the velocity of sound. The initiator lead azide has a rate of detonation of about 3800 meters/sec., whereas 50/50 Pentolite has a rate of 7500 meters/sec., making it adaptable to shaped charges.

Low explosives burn much faster than ordinary combustible materials such as wood or paper, but in much the same manner. Consider a low explosive initiated as in Fig. 2(b). The direction of burning is also away from the point of initiation, but the products of burning may move in any direction away from the burning surface, and they do not create a low-pressure situation like a detonation. The speed of the deflagration, or the **RATE OF BURNING**, depends upon many factors, such as the degree of confinement, area of the burning surface, and composition of the low explosive; it will be discussed in detail in the discussion of propellants. At the usual pressures existing in weapons this rate of burning is about 30-50 cm./sec. or about 1/10,000 the rate of detonation of high explosives.

Because of these differences in the speed and character of detonation and burning, we are able to understand more clearly the difference between the shattering effect of a high explosive and the power or displacement effect of a low explosive. The ability of a high explosive to shatter

the surrounding medium is called **BRISANCE**, and the ability of a low explosive to displace the surrounding medium is called **POWER**. The shattering effect is due, of course, to the tremendous rate of detonation, whereas low explosives exhibit the power of displacement due to their lower rates of burning.

HIGH-ORDER DETONATION or **BURNING** is obtained when all the explosive is completely detonated or burned with the maximum shattering or displacement effect that can be expected under a given set of conditions.

3. The Explosive Train.

It would be unfortunate if the high explosives which are used in large quantities as shell and bomb fillers were sensitive to initiation by shock, flame, or spark, because then the handling of such components would be so hazardous as to preclude their use as military explosives. Also, if the extremely sensitive explosives used as initiators were handled in large quantities, their use would be hazardous. The requirements are that sensitive initiators be used in very small quantities, and that shell and bomb fillers used in large quantities be insensitive.

Now this requirement creates a problem for the ammunition designer, because a small quantity of initiator will not detonate a large quantity of insensitive high explosive. The connecting link between these two is called an **EXPLOSIVE TRAIN**. It consists of a series of elements arranged according to decreasing sensitivity and increasing power or brisance. The first element contains a small quantity of very sensitive but not very powerful initiating material, and is called a **PRIMER**; the next element contains a large quantity of somewhat less sensitive but more powerful material, and is called a **DETONATOR**; the next element contains an even larger quantity of even less sensitive but even more powerful material, and is called a **BOOSTER**; and the last element contains a large quantity of insensitive but very powerful material, in the form of a shell or bomb **BURSTING CHARGE**. Each element is initiated by the one ahead of it and initiates the one following it, except the first which is initiated by firing-pin stab action, crushing action, flame, etc., and the last which is the culmination of the train, its purpose being accomplished when the last element detonates or burns high order.

Not all explosive trains contain exactly these four parts. The primer and detonator may be combined into one component. If a definite time delay in the train is desired, it is usually achieved by adding a small black-powder pellet between the primer and detonator; an additional element called a relay may be required to provide continuity of the explosive train by picking up the weak flash from the delay element and then in turn properly initiating the detonator. The necessity of

the relay depends upon the actual train design and the relative positions of the elements. Thus the train may have as few as three and as many as six or more elements in it.

Typical explosive trains are shown diagrammatically in Fig. 3. The usual low-explosive train is shown in (a), consisting of the artillery

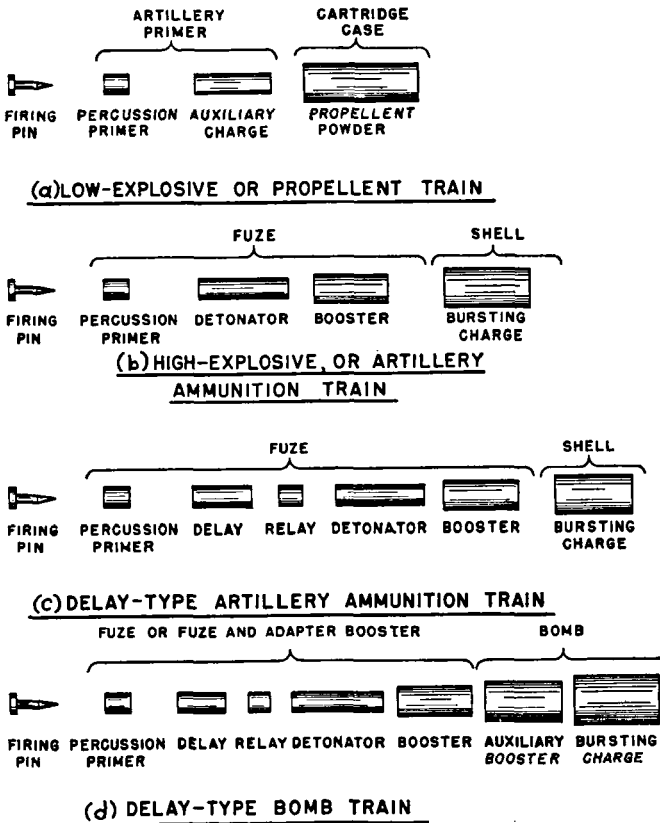

FIG. 3. Diagram of elements of explosive trains.

percussion primer with its small sensitive primer element and its larger igniting charge, followed by the large propellant powder charge. High-explosive trains are shown in (b), (c), and (d). The non-delay train is shown in (b), with separate primer and detonator, although they are sometimes combined. The train containing a delay and a relay is shown in (c), and a bomb delay train with delay, relay, and two boosters (because of the large quantity of explosive) is shown in (d). The actual primer, detonator, delay, relay, booster, and other components will all be discussed in detail in the appropriate chapters.

PROPELLANTS

4. General Requirements.

PROPELLANTS, as defined in Art. 2, are used to propel projectiles from weapons at comparative high velocities without damage to the weapon itself. The velocity may be as low as 150 ft./sec. for mortars and rockets and as high as 4000 ft./sec. for the newer high-velocity tank and antitank guns. The maximum pressure inside the weapon is another important consideration related to the propellant powder. For a given weapon and projectile, the composition and physical dimensions of the powder determine the pressure-time and velocity-time curves. Therefore, it is essential to understand the factors which affect the RATE OF BURNING of propellant powders. In fact, if all the powder in a gun were to be burned before the projectile had a chance to move an appreciable distance down the bore, the resulting pressure would blow up the gun, and the powder burning rate is usually such that the powder is not completely burned until the projectile has traveled about two-thirds the length of the bore. The result is an increasing volume for the expanding powder gases and therefore a decrease in pressure.

SMOKELESS POWDER is the name commonly given to modern propellant powder. In general, such powder is neither smokeless nor is it a powder, in the sense that we think of a powder as a very fine material like sugar or salt. The individual grains may be several feet long and of a variety of cross sections. They may be smokeless under certain conditions. Another important property of propellant powder is its flash characteristic, that is, the presence or absence of a large flash during burning. Such a flash is objectionable because it reveals the positions of guns and firing crews. Since powders may be stored for long periods of time, it is essential that they be stable under adverse conditions of temperature and humidity. It follows that we should like powders to be non-hygroscopic, as the absorption of moisture definitely aids rapid deterioration.

With these general requirements in mind, let us study the various types of propellant powders.

5. Rate of Burning.

A GRAIN of propellant powder is a single piece of powder, regardless of its size and shape; it may be several feet long and weigh several pounds. Propellant powder is made in a variety of forms, such as flakes, sheets, strips, cords or rods, and pellets. The cross section may be square, rectangular, circular, rosette, in the form of a cross, or any other shape desired. Typical grains of various cross sections are shown in

Fig. 4. The length of cylindrical grains is usually two to three times the diameter.

Properly ignited powder burns quite regularly from all ignited surfaces, the burning taking place in a direction perpendicular to the surface. In other words, the burning may be considered to remove successive layers from the burning surfaces, and it takes place with such uniformity

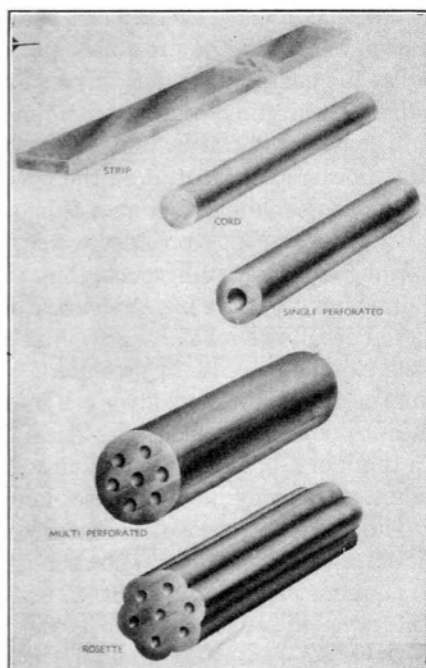
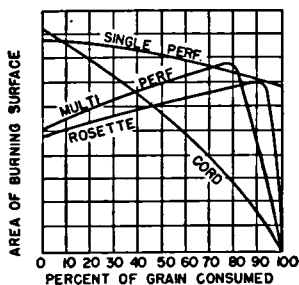
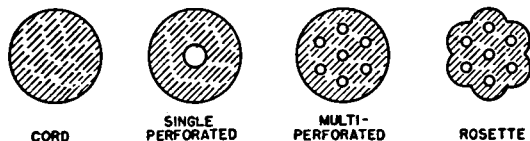

FIG. 4. Typical powder grains.

that markings cut or stamped on a surface remain identifiable during burning. A cylinder remains a cylinder throughout burning, the outside diameter decreasing as the burning proceeds towards the axis, and at right angles to it.

The rate of burning for a powder grain of given composition and burning under controlled conditions depends upon the size and shape of the grain. Since a cylinder burns only from the outside towards the axis, its burning surface decreases during burning, and such a grain is said to be a **DEGRESSIVE-BURNING** grain. The rate of gas generation decreases during such burning at constant pressure. In addition to cylindrical grains, strip and sheet powders are also of the degressive-burning type.

To combat this decrease in burning area, powder grains are sometimes perforated to create an inside surface which has an increasing burning area during burning. If the rate of increase of these increasing burning surfaces is the same as the rate of decrease of the decreasing burning



EFFECT OF GRAIN SHAPE ON BURNING RATE

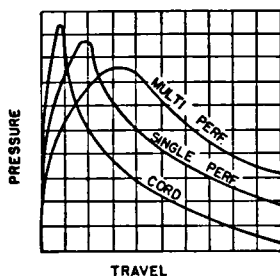

PRESSURE-DISTANCE CURVES FOR VARIOUS GRAIN SHAPES.

Fig. 5. Characteristics of powder.

surfaces, the powder is said to be NEUTRAL BURNING, because the net area of burning of the grain as a whole is constant. If the net burning surface increases during burning, the grain is said to be PROGRESSIVE BURNING; this result is accomplished by multiperforating grains of either cylindrical or rosette cross section.

The matter of neutral, progressive, and degressive burning is clearly shown in Fig. 5, in which the percentage of grain consumed is plotted against the burning surface in arbitrary units. A horizontal line, showing

no change in burning surface as the grain is consumed, would illustrate a neutral-burning powder, and the single-perforated grain is a good example. The rosette type and the multiperforated grain illustrate progressive burning as the burning surface actually increases until 80% has been consumed, and then it decreases quickly. The cord grain obviously loses burning surface from the start of burning, and at about a uniform rate.

For a single-perforated grain the **WEB** is defined as the distance from the periphery of the perforation to the outside of the grain, or the least burning thickness between parallel surfaces on a diameter, that is, one-half the difference between the outside and inside diameters. The **WEB AVERAGE** is the average of all the webs of a grain (Fig. 6). The web

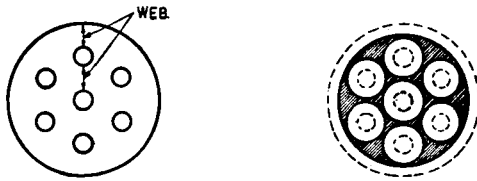

FIG. 6. Web and slivers of propellant powder grains. (Dotted lines show original grain size.)

thickness usually increases with caliber, but howitzers and mortars with shorter barrels require thinner webs to achieve complete burning before the projectile leaves the muzzle. Rockets require thicker webs in order to slow down the burning rate, as will be discussed in Chapter 11. In general, the higher the velocity, the thicker the web, in order to accelerate the projectile over a longer time consistent with maximum allowable chamber pressure. Furthermore, the heavier the projectile (other conditions remaining the same), the thicker the web, because a slower-burning powder is required to accelerate the projectile properly.

The effect of the different burning rates of different-shaped grains is shown in Fig. 5. Since cord powder burns fastest at the beginning, the pressure curve rises rapidly to a high pressure with little travel of the projectile but falls off very rapidly to a low pressure as the projectile emerges from the muzzle. Single-perforated powder has only a slight decrease in surface during burning, so that the pressure increases less quickly to a lower peak and falls off less rapidly. Multiperforated powder, which has an increasing burning surface, has a pressure curve that rises slowly to a lower peak but falls off much less rapidly.

American perforated propellant grains have either one or seven perforations. It sometimes happens that with the seven-perforation type **SLIVERS** are formed as the perforations enlarge to meet the decreasing

outer surface (Fig. 6). If the barrel is too short to allow complete burning of these slivers, they may be expelled from the muzzle unburned and cause a "muzzle flash"; unburned slivers, under any circumstances, are undesirable. In fact, the rosette shape was developed to prevent their occurrence.

Single-perforated grain powder is used in 20- and 37-mm. ammunition, in 75-mm. howitzer ammunition, and for certain charges of higher-caliber howitzer ammunition. Multiperforated grain powder is used for all other artillery ammunition.

6. Single-Base Powder.

SINGLE-BASE POWDER is the name given to propellant powder composed primarily of nitrocellulose and manufactured by the nitration of cotton. Depending upon the nitrogen content after nitration, nitrocellulose may be divided into three classes and used for three purposes: (a) below 12% nitrogen it is called pyroxylin, for use in lacquers, etc.; (b) between 12 and 12.75% nitrogen it is called PYROCOTTON, for use in propellant powders; (c) over 13% nitrogen it is called GUNCOTTON, for use in explosive manufacture.

The manufacturing process will not be described in this book. Single-base powder, also called "straight nitrocellulose powder" or "straight pyro powder," consists of 96% nitrocellulose and 0.50% diphenylamine (DPA), added as a stabilizer, the balance being residual solvents and moisture. The energy content of straight pyro powder is about 900 cal./gram. Straight pyro powder has the disadvantages of high hygroscopicity, instability, and high flash produced when fired, the flash being produced when unburned gases meet the outside air at kindling temperature and are reignited. Instability is evidenced by change in burning rate and energy content which affects resultant ballistics. Even though no deterioration may have taken place, straight pyro powder undergoes changes in its characteristics due to loss of the residual solvent during storage, such solvent averaging about 4% of the total weight.

7. FNH and NH Powders.

From these considerations, it is obvious that straight pyro powder is an unsatisfactory propellant for the extremely accurate artillery fire of modern war; to improve its characteristics and stability, various substances are added. These substances are called stabilizers, cooling agents, hygroscopicity inhibitors, etc.

Diphenylamine (DPA) acts as a stabilizer by combining with any nitrous fumes evolved as a result of deterioration that may be caused when nitrocellulose hydrolyzes, free acid being given off in the form of

gaseous oxides of nitrogen. These fumes accelerate the process, which might progress to the point where spontaneous ignition might result. DPA combines with these objectionable fumes and prevents deterioration as long as any uncombined DPA is still present. Straight pyro powder contains 0.50% DPA; the $\frac{3}{8}$ -in. rocket powder for the bazooka contains 0.75%, and the 60- and 81-mm. mortar powder contains 0.60%.

Dibutylphthalate (DBT), an oily viscous liquid, is an aromatic ester which acts as a cooling agent and an inhibitor of hygroscopicity. Its cooling properties are due to the fact that it is inert as an explosive, and it acts as a flash reducer by cooling the powder gases below their kindling temperature. It prevents changes in powder characteristics by replacing some of the volatile solvent usually present after manufacture, and it combats water absorption because of its oiliness. Our present standard M1 cannon powder contains from 3 to 5% DBT.

Dinitrotoluene (DNT) is a neutral solid used primarily as a stabilizer because it reduces hygroscopicity. Since it is explosive in nature and reduces the percentage of volatiles present, its use compensates in some measure for the loss in potential caused by adding the inert DBT. Standard cannon powders contain about 10% DNT.

By adding appropriate amounts of DNT, DPA, and DBT to straight nitrocellulose single-base powder, we derive single-base powders which are much less hygroscopic, sometimes flashless, and at the same time more stable. The so-called FNH (flashless, non-hygroscopic) powder is composed of 85% NC, 10% DNT, and 5% DBT. The so-called NH (non-hygroscopic) powder is composed of 87% NC, 10% DNT, and 3% DBT, both of these M1 powders having an energy content or potential of 750–800 cal./gram. Other single-base powders of varying amounts of these and other ingredients have been developed by a number of agencies, but the energy content is about the same. The density of most American powder is about 1.5 to 1.6.

The terms FNH and NH are relative and are related to the caliber of the weapon in which such powders are used. Strictly speaking, it is necessary to specify the powder, round, and weapon in order to state that a powder is flashless under certain conditions. Since the powder charge increases for larger-caliber weapons, it may not be possible to add enough DBT to cool the unburned gases to eliminate flash. In fact, since FNH and NH powders have about the same composition, flashlessness depends upon the weapon in which they are used. For example, the 75-mm. gun is not flashless when M1 FNH powder is fired in the M61 APC round, but when 1% potassium sulfate is added to the powder, for use particularly in the aircraft gun, the round becomes flashless and is so marked.

It is important to remember that the powder composition is not the only factor determining flashlessness. The design of the artillery primer is also a factor, and by adjusting the length, number, size, and spacing of the flash holes, and the amount of primer charge, it is sometimes possible to reduce flash. This flash has been reduced by use of the 19-in. M40 primer with 225 grains of black powder in the 90-mm. gun in place of the 11-in. M28 primer with 300 grains of powder. Usually flash reduction means more smoke because flash is really reignition of unburned gases; preventing such reignition tends to increase the quantity of smoke.

8. Double-Base Powders.

Since rocket motors and trench mortars are comparatively light in weight, the walls will not withstand high pressures. If the walls of a mortar were made heavy to withstand high pressures, the extreme mobility of mortars would be lost. Since ordinary single-base powder will not burn continuously and uniformly at low pressures (say 5000 lb./sq. in.) it is necessary to use some other powder. To obtain the advantages of smokeless powder and still have a satisfactory powder for these conditions, nitroglycerin is added to the nitrocellulose of single-base powder.

When liquid nitroglycerin is added to solid nitrocellulose and thoroughly incorporated, a colloidal gel is formed which varies from a horn-like plastic to a soft jellylike mass as the proportion of NG is increased. A plasticizer is usually added to this mass in order to assist in forming the colloid, and stabilizers are also added in small quantities.

The DOUBLE-BASE POWDER formed by adding NG to NC is used primarily for trench mortar and rocket powders; it consists of 50–60% NC and 50–40% NG. The present standard 60- and 81-mm. mortar powder is composed of 52.15% NC, 43% NG as a plasticizer, 0.80% DPA as a stabilizer, 1.25% potassium nitrate as a flash depressor, and 3% diethylphthalate. It is rolled into sheets for easy cutting into mortar increments. The 60-mm. square "flake" is 1 in. by 1 in. by 0.004 in. with a 0.25-in. center perforation. The 81-mm. square flake is made in two sizes, a smaller 1.44 in. by 1.44 in. by 0.008 in. flake with a 0.25-in. center perforation, and a 2.22 in. by 2.22 in. by 0.008 in. flake with a 1.21-in. center perforation. The small perforated flakes are held between the fins of the mortar fin assembly, whereas the large perforation of the 81-mm. flake allows it to fit around the stabilizer shank, a slit from the corner to center hole facilitating assembly.

Double-base powder has the advantage of high potential, the energy content of the standard mortar powder being about 1250 cal./gram. Double-base cannon powders have been developed, one such powder (M2) containing about 76% NC and 20% NG. Double-base rocket

powders will be discussed in Chapter 11. Double-base powders are standard for cannon smaller than 75 mm.

The British and Russians use double-base powder in the form of cords, called "cordite," and sheet double-base powder is sometimes called "ballistite." Certain double-base powders are manufactured by the solventless method by rolling the powder (called "rolled powder") into "carpet rolls" and then feeding the rolls into an extrusion press for forming into the desired grain size and shape.

9. Blending, Lot Numbers, and Loading Authorizations.

All the powder intended to constitute a lot is carefully blended so that all powder of that lot will have the same properties and characteristics in so far as possible. Then tests are conducted to determine just exactly what weight of that lot of powder is required to give a certain velocity in a certain weapon for a given round, and the chamber pressure is determined. *If satisfactory results are obtained, a LOADING AUTHORIZATION is issued, stating exactly what weight of that lot of powder is required to give a certain velocity at a certain pressure. Loading plants may not load propellant powder without such a loading authorization. Thus, the ballistics of the round are controlled, and variations from lot to lot of powder are taken into consideration.*

OTHER LOW EXPLOSIVES

10. Black Powder.

Although black powder may act as a low or a high explosive, depending upon the degree of confinement, it is now employed almost entirely as a low explosive and is so classified. It is the oldest explosive, having been known to the ancient Chinese, Arabs, and Hindus, and it has been used both as a bursting charge for projectiles and as a propellant. It is a most unsatisfactory propellant, because it is hygroscopic and unstable, burns with excess flash and smoke, leaves a solid residue, and has a burning rate difficult to control. It is used in projectiles as a spotting charge, but not in demolition or fragmentation projectiles. Nevertheless, it has certain special applications in ammunition which will be discussed.

BLACK POWDER is an intimate mechanical mixture of about 75% sodium or potassium nitrate (saltpeter), 10% sulfur, and 15% charcoal. It is extremely sensitive to initiation by any means, particularly a flame or spark, and unusual precautions must be observed during manufacture and handling. ARMY BLACK POWDER is made with potassium nitrate and is available in various granulations for various purposes. Its composition is 74% potassium nitrate, 10.4% sulfur, and 15.6% charcoal.

All army black powder is called Grade A, and the granulation is designated by numbers 1 through 7, the No. 1 granulation requirement being that 97% must pass a No. 4 U. S. standard sieve and 95% must be retained on a No. 8 sieve, and the No. 7 granulation requirement being that 97% must pass a No. 100 sieve and 50% must be retained on a No. 140 sieve. At the present time the No. 2 granulation is not used. Numbers 1, 3, and 4 are glazed, and Numbers 5, 6, and 7 unglazed. The finest granulation is called meal, or fuze powder and is used in loading fuze time train rings. Table 4 gives the general uses for the various granulations.

TABLE 4

GRANULATION	USES
No. 1	Igniting charges, artillery percussion primers, saluting charges.
No. 3	Special uses.
No. 4	Shrapnel base charges, fuze base charges, friction primers, smoke-puff charges, practice loaded bombs and projectiles, certain subcaliber shell fillers.
No. 5	Pellets for primers and fuzes.
No. 6	Pellets for primers and fuzes.
No. 7	Chemical ammunition.
Meal	Fuze time train rings.

COMMERCIAL BLACK POWDER, made with sodium nitrate, is also used in ammunition in two granulations: coarse Class A for saluting charges and finer Class B for spotting charges for practice bombs.

SAFETY FUSE, sometimes called BICKFORD FUSE, or MINER'S FUSE, consists of a compressed black-powder core or powder train, tightly wrapped and enclosed in a waterproof textile covering. It is a medium through which flame is conveyed at a continuous and fairly uniform rate to ignite some other element, such as a blasting cap or flame-sensitive detonator. It is made in two rates of burning, 30 and 40 sec./ft., although it can be obtained with slower rates of burning. The usual burning time obtained is within $\pm 10\%$ of the nominal. Many brands of such fuse are on the market, the differences depending on the degree of confinement of the powder, waterproofness, etc. This fuse is used for demolition purposes and to obtain delay action in ammunition components.

Despite the fact that black powder is regarded as being one of the worst explosive hazards, it can be used and handled satisfactorily if proper precautions are taken. It is almost ideally suitable in small delay pellets, where sealing to prevent moisture entrance is comparatively easy to obtain. But loose black powder is dangerous, and, since spotting charges require larger quantities, it is either handled in bags or cartons or mixed with inert material to form a spotting charge.

11. EC Blank Powder.

A particular single base powder known as EC BLANK POWDER, or EC Blank Fire, is composed of 80.4% NC, 8% potassium nitrate, 8% barium nitrate, 3% starch, and 0.6% DPA. Its sensitivity is greater than that of tetryl, almost the same as that of PETN, and its brisance is about the same as that of TNT. It has long been used as a bursting charge for hand grenades and as a filler for small-arms blank ammunition, and it is detonated by black powder or lead spitter fuse. (See Art. 4, Chapter 12.) Since it has some of the characteristics of high explosives, EC Blank Powder will be discussed with them later in this chapter.

12. Nitrostarch Explosives.

A typical nitrostarch explosive consists of 25% nitrostarch, 34% ammonium nitrate, and 40% sodium nitrate. This type of explosive was formerly used in trench mortar shell and hand grenades when TNT was not so readily obtainable as at present. It has no application in modern ammunition.

HIGH EXPLOSIVES

13. General.

High explosives produce a highly disruptive effect when properly initiated; the elements of the fuze and shell or fuze and bomb explosive train are composed of high explosives. In general, military high explosives are those which can be manufactured economically from available materials, are stable and non-gyroscopic, do not react with metals, possess sensitivity and brisance characteristics which allow their use for specific purposes, and can be easily handled in the loading plant (pressed, cast, pelleted, etc.). For mass production, it is essential that shell and bomb fillers be capable of being cast, that booster materials be capable of being pelleted, and that primer and detonator materials be capable of being pressed. Many an otherwise excellent high explosive is not used because of such practical considerations.

The important properties of high explosives will first be described, and then they will be classified according to their applications. It is not intended in this treatise to discuss in detail the subject of high explosives, but to give the ammunition designer a background so he may intelligently apply the principles of explosives to his design.

14. Important Properties of High Explosives.

Sensitivity. SENSITIVITY is one of the most important properties of explosives because high sensitivity is an essential property of an initiator

and low sensitivity a requirement of a bursting charge. Obviously, an explosive manufactured, loaded, and generally handled in large quantities must be comparatively insensitive for safety reasons. The initiators and boosters, which require high sensitivity to function properly, are normally handled in smaller quantities because only very small quantities are put into initiator-type components.

IMPACT SENSITIVITY is measured by a suitable drop test in which a 2-kg. ball falls from different heights on a given sample of the explosive. In the Bureau of Mines type of apparatus the unit of height is the centimeter; in the Picatinny Arsenal type of apparatus the unit is the inch, and there are other differences such as the degree of confinement which make results on the two machines not directly comparable. The larger the value of sensitivity, the lower is the actual sensitivity, because a higher height of drop is required to cause detonation or decomposition of the sample. The least height at which at least 1 of 10 trials results in detonation is called the sensitivity value, and these values vary from 2 to 20 in. on the Picatinny Arsenal machine and from 5 to over 100 cm. on the Bureau of Mines machine, Fig. 7.

FRICION SENSITIVITY is determined by a friction pendulum test in which a 7-gram sample of the explosive is exposed to the swinging action of a fiber or steel shoe. This test determines the qualitative behavior of the explosive since sensitivity so measured is related to this particular type of action and the test merely determines whether the particular explosive is ignited, decomposed, or detonated by the swinging action.

RIFLE-BULLET-IMPACT SENSITIVITY is measured by penetration of a caliber .30 rifle bullet fired through a $\frac{1}{2}$ -lb. sample of the explosive contained in a specified chamber. Because it is desirable that loaded components, particularly bombs (which have thin cases compared to artillery projectiles), be safe against functioning by penetration of a rifle bullet, this test has long served as a measure of this type of sensitivity.

Stability. Of course no explosive is suitable in ammunition if it does not possess a reasonable degree of STABILITY. It is never known how much time will elapse between the actual loading of a component and its use. The storage period may be days or it may be years. Therefore, explosives must be put in surveillance and be withdrawn and tested at certain intervals. In order to obtain such data quickly, as advance notice of how a given explosive will survive surveillance, accelerated tests at elevated temperatures are performed, by measuring loss in weight, quantity of gas evolved in a vacuum, time of appearance of first traces of oxides of nitrogen, and the temperature at which a small sample will ignite, explode, or decompose within a small time interval. Many otherwise attractive explosives have never found wide usage

because of instability, and it is this factor, more than anything else, which resulted in the replacing of mercury fulminate by lead azide as the standard initiator.

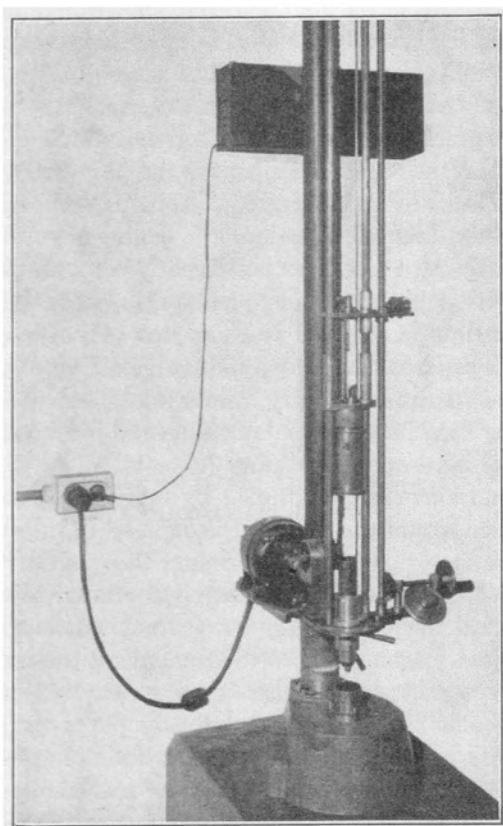

FIG. 7. Bureau of Mines impact-test machine.

The stability of several well-known explosives is given in Table 5. Note that TNT is about 6 times as stable as tetryl, and almost 10 times as stable as 50/50 amatol, judged by one particular standard.

TABLE 5

VOLUME OF GAS EVOLVED IN 40 HR. IN VACUUM AT 120° C.

50/50 amatol	4.53 cc.
Tetryl	2.98
Explosive D	0.52
TNT	0.44

Brisance. The term BRISANCE applied to explosives is defined as the quality of a high explosive evidenced by its capacity to shatter a confining medium. It is measured in a sand test bomb containing 200 grams of a specified type of sand into which a No. 6 blasting cap containing a 0.4-gram sample of the explosive is placed. The minimum amount of mercury fulminate (or tetryl) required to cause the explosive to crush the maximum net weight of sand is a measure of SENSITIVITY TO INITIATION and is really a fourth method of measuring sensitivity. The net weight of sand crushed is called the SAND-TEST VALUE, which is an index of brisance and is obtained by subtracting from the total the amount of sand crushed by the initiator alone. The greater the value, the higher is the brisance of the explosive. The explosives in use today crush between 18 and 62 grams of sand by this test.

Another test which measures the strength of an explosive is the BALLISTIC MORTAR TEST in which is determined the amount of explosive under test required to raise a heavy ballistic pendulum to the same height to which it is raised by 10 grams of TNT. These test results show a fair agreement with the volume of hot gaseous explosion products for various explosives. The test explosive causes the pendulum to swing because of the reaction due to expelling a small mortar-type projectile from the swinging end of the pendulum.

Rate of Detonation. RATE OF DETONATION is a measure of the actual rate of propagation of the detonating wave through the explosive, or the rate at which the explosive is consumed as detonation progresses. It is usually measured photographically, and it varies with the explosive density, which in turn may vary with the method of loading. The rate of detonation of high explosives varies from 2900 to 8300 meters/sec. TNT has a rate of 6790 meters/sec. when cast, but this rate varies from 5560 to 6970 as the density varies from 1.2 to 1.6.

Fragmentation. The number and the weights of fragments retained on a 4-mesh screen and produced when a shell explodes are determined. The shell is functioned electrically after being buried in sand; the fragments are collected by sifting the sand and are then classified into weight groups of 0 to 75, 75 to 150, 150 to 750, 750 to 2500, and over 2500 grains. The percentage recovery is the total weight of the fragments compared to the unfragmented shell weight. A typical 75-mm. high-explosive shell fragmentation would result in 95% recovery and a total of 1000 fragments, about half of them in the 75- to 100-grain zone and the other half in the 150- to 750-grain zone or thereabouts.

15. General Classification of Important High Explosives.

Table 6 classifies explosives into three types according to energy, rate of detonation, and sensitivity. In addition, the primary explosives are separated from the derived explosives.

TABLE 6
GENERAL CLASSIFICATION OF IMPORTANT HIGH EXPLOSIVES

Energy, cal./gram	300-500	500-1000	Over 1000
Rate of detonation, meters sec.	3000-4000	5000-7000	6500-8300
Sensitivity (Bureau of Mines machine)	(Most) 5-10	(Least) 90-100	(Intermediate) 15-80
Primary explosives	Lead azide Mercury fulminate	TNT D Picric acid	Haleite PETN Cyclonite Tetryl
Derived explosives	Primer mixtures	TNT + ammonium nitrate = amatol TNT + tetryl = tetrytol TNT + ammonium picrate = picratol TNT + aluminum = tritonal TNT + ammonium nitrate + aluminum = minol	TNT + Haleite = ednatol TNT + PETN = pentolite TNT + cyclonite = RDX-B TNT + tetryl + cyclonite = PTX TNT + aluminum + cyclonite = torpex TNT + ammonium nitrate + aluminum + cyclonite = DBX

PRIMARY EXPLOSIVES are composed of one chemical compound, have chemical names as well as trade names, and can be specified by structural formulas. DERIVED OR SECONDARY EXPLOSIVES are usually solutions or mixtures of two primary explosives, such as tetryl dissolved in molten TNT. In fact, TNT is almost always one of the ingredients of these BINARY EXPLOSIVES, as can be seen from Table 6. Some work has been done on mixtures of three explosives, called TERNARY EXPLOSIVES, the object being to obtain some special combination of properties.

Study of this table shows clearly that there are two types of primary high explosives: the very sensitive, low-energy-content, low-rate-of-detonation, and low-brisance explosives, such as mercury fulminate and lead azide, which make ideal initiators; and the insensitive, fairly high-energy-content, fairly high-rate-of-detonation, and high-brisance explosives, such as TNT, which make ideal shell and bomb fillers. To these must be added a third type, consisting of some older explosives like tetryl and PETN, and some newer explosives like Haleite and cyclonite,

which have intermediate sensitivity but very high energy and a very high rate of detonation.

16. Explosives Considered from Viewpoint of Application.

Let us now discuss individually the explosives commonly used as initiators, boosters, and bursting charges, and see how their properties fit them for their different purposes.

Initiators. For initiating the explosive train, as discussed in Art. 3, we use small quantities of very sensitive explosives, the most important of which are lead azide and mercury fulminate. They need not be capable of being cast, brisance is a secondary consideration, but they must be sensitive to initiation by firing-pin action, crushing action, flame, etc.

1. **LEAD AZIDE** is the most sensitive of the modern military explosives, though when mixed with 2 to 8% of dextrin, to facilitate handling in a loading plant, it is a little less sensitive than pure mercury fulminate. Nevertheless, it is still a very sensitive as well as a very satisfactory initiator, because of its non-hygroscopicity and good stability, and it has replaced mercury fulminate almost exclusively. It is usually handled in small quantities, the common detonator charge seldom being more than 300 mg., and is loaded in aluminum cups, inasmuch as it reacts slowly with copper or gilding metal. It is a white, crystalline powder.

2. **MERCURY FULMINATE**, although formerly used extensively as an initiator, has been replaced by lead azide because fulminate is unstable when stored under tropical conditions. It has the further disadvantage that it loses sensitivity if pressed at more than 30,000 lb./sq. in.; that is, it becomes "dead pressed." It is still used in some primer mixtures.

3. **PETN** (Pentaerythrite Tetranitrate) is intermediate between an initiator and a detonating explosive, having a sensitivity the same as azide but a sand-test value higher than TNT. It is classified as an initiating agent for handling and transportation purposes, and it acts as such when it forms the core of the much-used **DETONATING CORD**, called **PRIMACORD**. On the other hand, when mixed with other high explosives, like TNT and cyclonite, it serves as a filler for high-explosive shell.

This detonating cord consists of a PETN core enclosed in a waterproof sheath with reinforcing coverings, and initiated by a blasting cap, detonator, or other suitable component. The cord is about 0.2 in. in diameter and of any practical length desired. The rate of detonation is about 20,000 ft./sec. There are three commercial types: plain, with cotton covering; reinforced, with additional cotton covering; and wirebound, with both cotton and wire covering, having higher tensile strength, resistance to abrasion, etc. Primacord is used for transmitting a detonating wave from one place to another without loss of time.

Boosters and Bursters. For transmitting the impulse of the initiator to the bursting charge so that HIGH-ORDER DETONATION takes place, an intermediate explosive, somewhat less sensitive than the initiators but having a high brisance, is chosen. It is called a BOOSTER, because it boosts or amplifies the initiator impulse. Another application of such an intermediate explosive is in BURSTERS, where the burster replaces the booster in the train for the purpose of rupturing a component but not shattering it as a high-order detonation of a standard shell or bomb filler would do. The use of boosters and bursters will be explained in the discussion of ammunition components; only the explosives themselves will be explained here.

1. Tetryl (trinitrophenylmethylnitramine). The one explosive filling all booster needs today is called TETRYL, a fine crystalline yellow powder almost as sensitive as azide and even more brisant than TNT. Of course, its high sensitivity precludes its use as a component bursting charge, but its high stability, ease of pelleting, and high brisance, combined with this high sensitivity, make it an ideal booster explosive. It is also used as a bursting charge for small-caliber projectiles, say 40 mm. and under.

2. Tetrytol. The burster of chemical and smoke shell and boosters of bombs were formerly loaded with tetryl pellets, but mass production demanded an explosive that could be cast. TETRYTOL, consisting of 65% tetryl and 35% TNT, was found to be very satisfactory, having about the same sensitivity and brisance as tetryl. It has now replaced tetryl in shell and bomb bursters.

Bursting Charges. Bomb and shell fillers require explosives which have maximum brisance combined with relative insensitivity, so that they can be loaded and handled with comparative safety. Primary explosives of this type are TNT, explosive D, Haleite, and cyclonite; when mixed with other explosives, fillers like ednatol, pentolite, amatol, and picratol result.

1. TNT (trinitrotoluene). By far the most widely used and best-known explosive is TNT. It has the appearance of light brown sugar and is sufficiently insensitive to be safely manufactured, loaded, and shipped; it is non-hygroscopic, stable, and withstands surveillance very satisfactorily; it can be mixed with other explosives to form a variety of compounds having a variety of desirable properties; and it will burn (if not confined unduly) without detonation. So here is an explosive that has the high brisance required for a general high-explosive shell and bomb filler, is easy to make and handle, and can be shipped around the country in wood boxes in freight cars.

In addition to being the most general component filler, TNT is used in demolition devices.

2. Explosive D. *EXPLOSIVE D* is ammonium picrate. Although its brisance is somewhat less than that of TNT, it is used in armor-piercing projectiles because of its comparative insensitivity to shock and friction. It has the disadvantages of requiring loading by pressing and of being somewhat hygroscopic. However, a shell containing it can penetrate thick armor without detonation until the plate has been negotiated, so that the detonation takes place inside a tank, ship, or fortification.

3. Haleite (ethylene dinitramine). The use of *HALEITE* (named for Dr. G. C. Hale of Picatinny Arsenal), or *EDNA*, has increased during the last few years because of the availability of a better manufacturing process and its excellent properties. *It has the highest brisance of all the explosives of comparable sensitivity and therefore is somewhat unique as an explosive. It has a higher rate of detonation than TNT, but it cannot be cast.*

4. Cyclonite (cyclotrimethylenetrinitramine) is another primary explosive, variously known as *CTMTN*, *T4*, and *RDX*, though in this country we reserve the name *RDX* for various compounds of cyclonite. Cyclonite also combines high sensitivity and brisance, being about as sensitive as azide and more brisant than TNT and tetryl but not quite so brisant as *PETN*. Cyclonite, which cannot be cast, is used primarily with other explosives to form mixtures, principally the various *RDX'S*, some of which can be cast.

5. *RDX compositions.* If cyclonite is mixed with a small quantity of wax, the resulting mixture is known as *RDX-COMPOSITION A*, and is about as insensitive as D but much more brisant, even more brisant than TNT. It is loaded by pressing into components such as armor-piercing shell which are required to withstand shock before detonation.

A mixture of cyclonite, TNT, and a small quantity of wax is called *RDX-COMPOSITION B* (*B-2* if the wax is omitted); it can be cast and makes an ideal explosive for bombs, especially fragmentation bombs, where insensitivity must be combined with high blast effect. The sensitivity of *RDX-B* is only a little more than that of TNT, but the brisance is between that of *ednatol* and cyclonite. At present, most bombs are loaded with either TNT or *RDX-B*, the latter having replaced *amatol*, which has only about half the blast effect.

A *PLASTIC EXPLOSIVE* known as *RDX-COMPOSITION C* is formed by mixing about 88% cyclonite with 12% plasticizer. It is more brisant than TNT, about as insensitive, and can be formed on the spot into all shapes as well as tamped into components. It is therefore used in demolition work and has been tried in bombs where it is desired to spread an

explosive over an area at impact, as upon concrete fortifications. Other plastic explosives of cyclonite are known as RDX-C2 and RDX-C3.

6. Explosives for shaped-charge components. The requirement for shaped-charge explosives is fairly high sensitivity for ease of initiation combined with high rate of detonation to form the most effective jet. In addition to ednatol, PENTOLITE, a mixture of 50% PETN and 50% TNT is used because of the effect produced by combining these properties. CYCLOTOL has also been considered for shaped charges.

7. Aluminized explosives. Certain mixtures of finely divided aluminum and other explosives are used for under-water demolition work, as in torpedos and depth bombs. TRITONAL, a mixture of TNT and aluminum, combines low sensitivity and high blast effect. MINOL is a mixture of ammonium nitrate, TNT, and aluminum; MINEX is a mixture of ammonium carbonate, cyclonite, TNT, and aluminum; DBX is a mixture of ammonium nitrate, cyclonite, TNT, and aluminum.

8. Amatol. The various mixtures of ammonium nitrate and TNT are called AMATOLS, the usual percentages being 80/20, 60/40, and 50/50. Amatol was formerly used in quantity bomb loading when toluene was not available in large quantities for making TNT, but being very hygroscopic and reacting unfavorably with certain metals it has been replaced by TNT and RDX-B.

17. Summary of Properties of Important Explosives.

For general reference purposes, to help the ammunition designer classify explosives in his mind, Table 7 is presented, in which high explosives are arranged according to decreasing sensitivity and increasing brisance.

In this table, sixteen high explosives have been arranged according to decreasing sensitivity in one column and increasing brisance in the other. Those that can be cast are preceded by "C"; those that are usually pressed, by "P"; and those usually pelleted by "PL." Bursting charges require high brisance and low sensitivity and should therefore be near the bottom of both columns, as pentolite, ednatol, and Haleite. Initiators should be at the top of both columns, as fulminate and azide. PETN is an exception since it combines high brisance and high sensitivity. Explosive D is used despite its low brisance because the requirement of insensitivity is so important in armor-piercing projectiles. The table shows that ednatol, which can be cast and is very stable, would make a good bursting charge because it has a higher brisance than TNT and is about as insensitive. For a complete description of the composition, manufacture, and properties of high explosives, consult one of the many standard textbooks.

TABLE 7

IMPORTANT EXPLOSIVES ARRANGED ACCORDING TO SENSITIVITY AND BRISANCE

	<i>Decreasing Sensitivity</i> (Bureau of Mines Machine)		<i>Increasing Brisance</i> *	
			(grams sand crushed)	
P	Mercury fulminate	5	Lead azide	18
P	Lead azide	10	Mercury fulminate	22
P	PETN	17	D	37
	EC blank fire	19	Amatol 50/50	39
PL	Tetryl	26	TNT	43
C	Tetrytol	28	EC blank fire	45
P	Cyclonite	32	Tritonal	46
C	Pentolite	34	Ednatol	48
	Torpex	38	Haleite	51
P	Haleite	48	RDX-B	52
C	RDX-B	75	Tetrytol	52
C	Amatol 50/50	95	Tetryl	53
C	Ednatol	95	Pentolite	53
C	TNT	95-100	Torpex	58
P	D	100+	Cyclonite	59
	Tritonal	100+	PETN	62

* Loaded under constant pressure; if loaded to the same density, a slightly different order will result in this table.

18. Compatibility of Explosives with Ammunition Materials.

A very important property of an explosive is its COMPATIBILITY with non-explosive materials used in ammunition. Because explosives are in direct contact with metals, coatings, plastics, and other materials, and the ammunition may be stored for long periods under adverse conditions, it is essential that the designer have information as to what explosives are or are not compatible with the materials commonly employed in ammunition. It is generally true that it is not desirable to have explosives in direct contact with metals in ammunition, and for that reason platings and coatings are used. If the explosives contained no moisture and were loaded under dry conditions this would be unnecessary, but since there is always a small percentage of moisture in the explosives and since practical loading conditions are such that some moisture is in the air, the general requirement of plating or coating is one the designer must keep in mind.

Incompatibility may be evidenced by corrosion alone or by the formation of a sensitive compound as the reaction takes place. The usual tests consist of storing explosives in contact with various materials including coatings for long periods of time, say two years, at ordinary and at elevated temperatures, say up to 50° C., and using explosives as dry

as can be obtained and with considerable moisture present, say 0.5%. This moisture content is much higher than that allowed by specifications, which is of the order of 0.10 to 0.15%. The nature and extent of the reactions are difficult to predict even by a trained explosives chemist, and as new explosives become available and as new materials are tried in ammunition, it is essential that all the combinations of explosives and materials that are contemplated be investigated from the compatibility standpoint by a surveillance type test.

In order to guide the ammunition designer, some general observations will be made with reference to high explosives:

Dry explosives, except amatol (with the minimum moisture content practical in manufacture, as near 0% as possible), have no effect on any of the metals or metal coatings used in ammunition.

Any explosive containing an inorganic salt like ammonium nitrate or potassium chlorate will cause corrosion of most metals and metal coatings even with very small moisture content, much less than allowed by the specifications. For example, amatol will cause corrosion of metals and coatings even though it is kept as dry as possible; this is one of the reasons why shell and bomb cavities should be coated with acidproof black paint and that bombs loaded with amatol have nose and tail pads or surrounds around the fuze cavities for protection. It is a general rule that all shell and bomb cavities should be coated even though 50/50 amatol or other inorganic salt explosive is not used because it is just good practice to coat all metal surfaces in contact with explosives.

The combination of any explosive with a metal or coating with which it reacts to form a sensitive compound should be avoided. Picric acid, lead azide, and Haleite form such sensitive compounds with certain metals. Lead azide in the presence of moisture will react with copper to form the highly sensitive compound copper azide, and lead azide is customarily loaded in aluminum cups for this reason. Picric acid reacts with lead and some other metals to form sensitive salts. The solution of this problem is to avoid the worst combinations and to coat metal surfaces where the condition cannot be avoided. Lead azide and tetryl in aluminum cups cause no difficulty. Primer mixtures may cause trouble, and lead sulfocyanate primer mixture may react with aluminum. Detonator cups loaded with lead sulfocyanate mixture are made from copper or gilding metal, and if azide is used as a secondary charge the cup is coated with shellac and aniline dye solution to avoid the formation of copper azide, another example of compromise in the design of ammunition. All copper and gilding metal cups should be coated.

TNT is the best example of an explosive which has no reaction with any of the materials used in ammunition. If moisture is present, there

might be some effect from that moisture itself but not directly from the TNT.

Moist explosives and moisture conditions during loading of hygroscopic explosives must be avoided. Tests show that most all explosives having 0.5% moisture have reactions at 50° C. with all the metals and usual metal coatings except stainless steel. Haleite and ednatol have a more pronounced effect than some of the other explosives. Stainless steel and aluminum are in general the most resistant metals.

When plastics are used in contact with explosives, the effect is likely to be decomposition of the explosive rather than harmful effect on the plastics. Tests on fifteen of the commonest commercial plastics show there is no serious adverse effect upon the stability of the usual explosives except for 50/50 amatol and 75/25 tetrytol. But here again it must be remembered that each combination must be considered, and tested by itself, especially since the number and variety of new plastics are so great.

THE SHAPED-CHARGE EFFECT

19. General Description.

If an explosive charge with a flat surface is placed against a steel plate, as in Fig. 8(a), some damage will, of course, be done to the

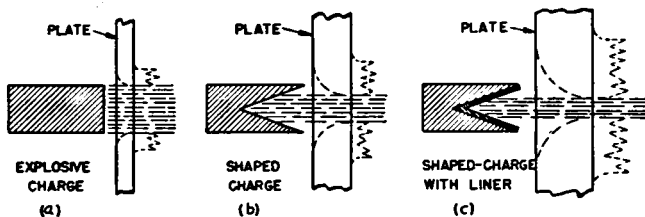

FIG. 8. Illustration of shaped-charge principle.

plate, and, if the charge is sufficient and the plate not too thick, penetration will result. It has long been known that, if some of the charge near the plate is removed, greater penetration will result; that is, more penetration is obtained with less explosive, though the diameter of the hole will be decreased as in (b). If the shaped portion of the charge is lined with a comparatively thin material, as in (c), even greater penetration is obtained.

The exact nature of this effect is not precisely known, but it is being studied in great detail. It was first discovered by Professor Charles E. Munroe in the 1880's, when he was working at the Naval Torpedo Station at Newport, R. I. He noticed that cavities in blocks of gun-cotton were reproduced in the iron plates on which the explosive was test

fired. Further experiment showed that the effect could be produced with almost any kind of high explosive by cutting a cavity of almost any size or shape in the side of the charge placed towards the object to be cut, punctured, perforated, or damaged. Demolition engineers have long applied this principle when they cut out a little chunk of dynamite before placing the stick against the object to be destroyed. This effect is

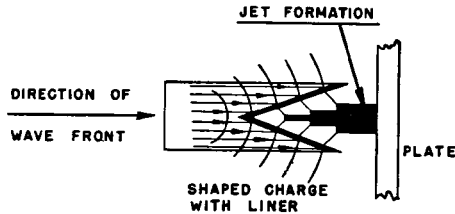

FIG. 9. Formation of shaped-charge jet.

variously called the Munroe effect, the Neumann effect, the cavity effect, the hollow-charge effect, or simply the SHAPED-CHARGE EFFECT.

One of the most important developments of World War II is the application of this principle to the design of practical ammunition to use against our enemies. It has been applied to rifle grenades, rockets, artillery projectiles, bombs, demolition charges, and even to fuze detectors.

The investigation of this effect is the subject of extensive research, but the general nature of the phenomenon and many of the variables involved may be understood by consideration of Fig. 9. As the detonation of the explosive proceeds, the wave front moving towards the liner first reaches the apex of the liner, the waves being refracted inward at approximately right angles to the liner, and reinforcing themselves on

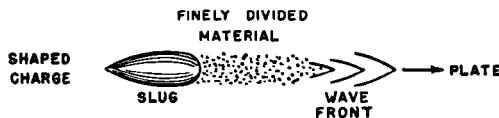

FIG. 10. Components of shaped-charge jet.

the axis. The effect is cumulative as the wave front reaches other portions of the liner, until a jet with a velocity at least as high as that of the rate of detonation of the explosive itself is established. The jet is composed of a front portion in the form of a pressure or shock wave moving at a velocity somewhat in excess of the explosive rate of detonation; followed by the very finely divided material of the liner moving at a velocity also in excess of the detonation rate; followed sometimes by a

portion of the liner (particularly of a metallic conical liner) not converted to finely divided material, and in the form of a slug, moving at less than the detonation rate. All this is shown in Fig. 10. Focusing takes place just as if the explosive wave were streams of water, rays of light, or sound waves, and penetration takes place because the high-velocity jet has high energy, pressure, and heat and therefore does more damage than the flat side of an unshaped explosive charge.

20. Factors Affecting Penetration.

Geometrical Considerations. In Fig. 11, some of the factors affecting penetration are shown, and the table gives definitions and optimum values for some of the variables.

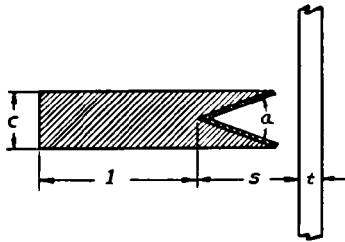

FIG. 11. Proportions of shaped charge.

- Let s = STANDOFF DISTANCE, distance between apex of liner and plate.
 c = CALIBER, diameter of charge.
 l = length of explosive back of liner.
 t = thickness of plate penetrated.
 a = included angle of liner.

VARIABLE	OPTIMUM VALUE
s	1 to $3c$.
l	At least $4c$; probably a value over $6c$ results in no additional advantage, provided charge is initiated from that front.
a	30 to 45° .
t	Static test values: without liner—less than $1c$. with glass liner—over $1c$. with metallic liner—3 to $4c$.
Liner material	Dense material best, particularly steel and copper.
Liner shape	Conical generally used, though hemispherical may have some advantages in minimizing slug.

Explosives. Since penetration depends upon the high velocity of the jet, and since the jet is formed by an accumulation of shock waves, the higher the rate of detonation of the material, the greater the penetra-

tion. It may be desirable to employ a sensitive explosive easily initiated, provided, of course, that it is not so sensitive that it detonates at the surface of the plate at impact. Initiation from the rear is a requirement for penetration. The explosive which has been used quite extensively is 50/50 pentolite, because of its high rate of detonation and sensitivity. Other explosives are being investigated. Ordinary explosives like TNT could be employed if means for proper initiation and space for proper length of explosive are available.

Effect of Rotation. It has been found that if the shaped charge is rotated at a high rate of spin, say 10,000 r.p.m., such as is obtained with artillery projectiles, the effect of penetration is greatly reduced. This is indeed unfortunate, as projectiles require rotation for stability. The static penetration figure of 3 to 4 calibers is reduced in armor-piercing projectiles to $1\frac{1}{2}$ to 2 calibers for this reason. The practical effect of spin is in general to reduce penetration as spin increases from 0 to about 200 r.p.s. to about 50% of static penetration, after which further spin has little detrimental effect.

Method of Initiation. The various methods of fuzing and boosting shaped-charge projectiles and other ammunition components will be discussed in the appropriate chapters. It is well to mention here, however, the detrimental effect of (1) the presence of any foreign material or body in front of the liner which will interfere with jet formation or with jet action after formation, thus decreasing its power of penetration; and (2) the removal of the central portion of the liner as may be necessary when front-end initiation is employed and transmitted to the rear to obtain a rear-end detonation of the charge. Needless to say, the central portion of the charge and liner contributes to the jet formation.

21. Application.

Although the shaped-charge effect is a very old principle, not until about 1939 did the Ordnance Department begin to apply it in practical armor-piercing ammunition. The many components which have been developed since that time will be discussed in the appropriate chapters.

CHAPTER 3

PRIMERS, DETONATORS, AND TRACERS

1. General Description.

The design of primers and detonators for the explosive train is so important that it will be treated separately in this chapter. Primers and detonators may be used in all types of ammunition—small-arms, artillery, aircraft, rocket, pyrotechnic, and miscellaneous—and an understanding of their construction, functioning, and application is essential for correct ammunition design. Primers and detonators are small components, but the failure of a one-cent primer may waste a ten-thousand-dollar bomb, or the malfunctioning of a detonator may cost many lives, to say nothing of the labor and expense of carrying the bomb to its target over enemy territory or the loss of a strategic objective because of duds or other ammunition failure. The ammunition designer must know the principles of primer and detonator construction and functioning in order that the metal parts and explosive train designs may be effective and function exactly as desired.

Tracers, on the other hand, are used primarily in small-arms and artillery ammunition, but since there are several types of designs and many different applications they will be discussed in this chapter also.

PRIMERS

2. Description and Types.

“Primer” is one of those ambiguous words which needs qualification. Primers are of two general types: one used in fuzes, pyrotechnics, small-arms ammunition, and other components to initiate the explosive train and called a FUZE PRIMER or SMALL-ARMS PRIMER; and the other used in artillery cartridge cases to initiate the propellant powder explosive train and called an ARTILLERY PRIMER. The artillery primer is larger and longer, and it contains a fuze-type primer element as well as a booster charge of black powder. The fuze primer is a small percussion element containing the primer mixture only, and not attached to any other element. Except for the 20-mm. cartridge case primer, which is of the fuze-primer type, artillery primers vary from 1 to 19 in. in length, and

from $\frac{5}{8}$ to 1 in. in diameter, whereas fuze primers are seldom over $\frac{1}{4}$ in. in diameter and $\frac{1}{2}$ in. long. We shall include in our discussion of artillery primers a description of mortar percussion primers, which consist of the head and assembly of an artillery primer but are without the long tube of black powder.

3. Primer Mixtures.

PRIMER MIXTURES are mixtures of ingredients in suitable proportions to be extremely sensitive to flame, stab action, shock, or some method of initiation. The two most common methods of initiation are crushing action, such as is obtained when the primer in the front of the fuze crushes against a resistant target, and stab action, obtained by pushing a firing pin or striker against the primer. These mixtures usually contain a sensitive explosive like mercury fulminate, lead azide, or lead sulfocyanate, an oxidizing agent like potassium chlorate, and a fuel like antimony sulfide, which also affects sensitivity. Carborundum or ground glass may be added to increase sensitivity.

Important properties of primer mixtures are sensitivity, impulse, gas volume, and duration of flash. The apparatus for measuring some of these properties will be discussed in Art. 4. The much-used No. 70 mixture (lead sulfocyanate, potassium chlorate, antimony sulfide, and TNT) has a higher impulse, lower gas volume, and higher sensitivity than, and about the same duration of flash as, the No. 74 mixture (mercury fulminate, potassium chlorate, and antimony sulfide). The No. 100 mixture is the same as the No. 70 mixture except that the TNT is replaced by lead azide. It must be remembered that the state as well as the properties of the ingredients (fineness, method of mixing, etc.) determines the properties of the primer, and almost any combination of properties can be obtained. Commercial primer mixtures, used in commercial primers, may contain other ingredients, as much as 10% barium nitrate, for example. The sensitivity of a primer mixture and of a given primer component depends on the contour of the firing-pin point, the velocity of entrance, the degree of penetration, and the actual crystalline structure, blending, and purity of the mixture, as well as on the mechanical design of the primer.

4. Fuze Primers.

Description and Uses. A FUZE PRIMER is a small explosive component for initiating a detonation in an explosive train and transmitting it to the next component in the train, such as a detonator or delay. It may be functioned by the stab action of a firing pin or by crushing action. These fuze-type primers are small components, seldom more than $\frac{1}{4}$ in.

in diameter and $\frac{1}{2}$ in. long, and are loaded with primer mixture only. They must have sufficient sensitivity to be functioned by the minimum blow expected and sufficient impulse to flash through any channel required, including turns, and sufficient gas volume to fill obturated chambers and insure uniform burning of delay pellets.

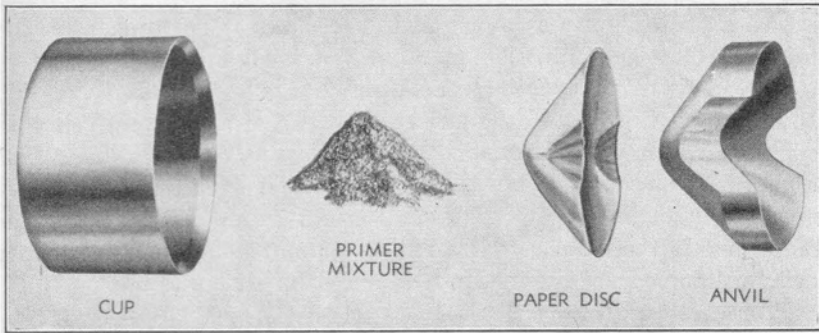

FIG. 12. Components of fuze-type primer.

Uniformity in manufacture is essential, since the parts are small and have close tolerances, and the primer charge is seldom more than 1 grain. Yet the performance of the complete item of ammunition depends on the accurate and dependable functioning of such a primer.

Types.

1. Anvil construction (obturated type). This type, Figs. 12 and 13(a), consists of a cup into which the mixture is loaded with an anvil pressed

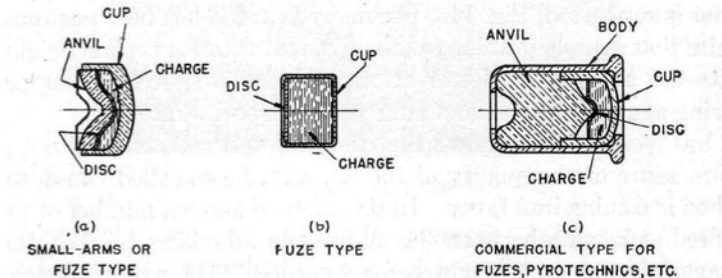

FIG. 13. Typical fuze-type primers.

into the open end of the cup, its point extending slightly into the mixture. A paper disc is placed over the mixture before assembly to assist in sealing. A primer of this type, sometimes made by commercial concerns, is pressed into an ammunition component and fired by hitting the bottom of the cup with a firing pin, which forces the mixture against

the anvil. Since the cup is not pierced, obturation (sealing) is obtained after the primer is fired because the primer as a whole is pressed into its containing cavity.

The anvil and cup may be held together by a body crimped over the anvil and open at both ends. Figure 13(c) shows a typical primer of this type, usually manufactured by commercial concerns. This primer is also a press fit into a cavity, and, as the cup is not broken by the firing-pin blow upon functioning, obturation is obtained.

2. Non-anvil construction (unobturated type). In this type, Fig. 13(b), the anvil is absent, the primer consisting of a comparatively thin cup into which the primer mixture is loaded and sealed with a disc crimped to the cup. When the primer is fired by a firing pin or by crushing action, it so disintegrates that no obturation results. This type of primer is therefore used to initiate detonators but not to initiate delay columns, since obturation is required for that purpose.

Properties and Testing.

1. Sensitivity. One of the most important properties of fuze-type primers is PRIMER SENSITIVITY. It is extremely essential that a primer fire under certain known conditions, so that the design of the components with which the primer is combined may be based on these conditions, thus guaranteeing functioning if the minimum conditions are met. The functioning of a complicated, expensive shell or of a blockbuster depends upon the functioning of the tiny element known as a primer, which initiates the detonation.

Sensitivity is usually measured by dropping a ball of known weight from specific distances on the firing pin of a test fixture in which the primer is supported, Fig. 14. For many years, it has been customary to require that sample primers from a given lot fire at a certain height, and fail to fire at a certain lesser height, this last requirement supposedly insuring against firing in handling and transportation.

It has recently been shown that the drop-test method does not give a true measure of the quality of the lot, and the so-called run-down test method is coming into favor. In this method a given number of primers are fired at heights between the all-fire and all-misfire heights, the percentage firing at each height being recorded. The average height and standard deviations are computed to determine the satisfactoriness of the lot by comparing with standards established from a consideration of the quality level it is desired to maintain.

Sensitivity depends upon a number of factors such as weight of charge, composition, dimensions of metal parts, and anvil position, and the effects of these variables on sensitivity are being studied in detail.

2. Impulse. When a primer is fired, the force of detonation or length of "spit" is called **IMPULSE**; it is measured by the maximum displacement of a mercury column resulting from firing the primer in apparatus designed for the purpose, Fig. 15.

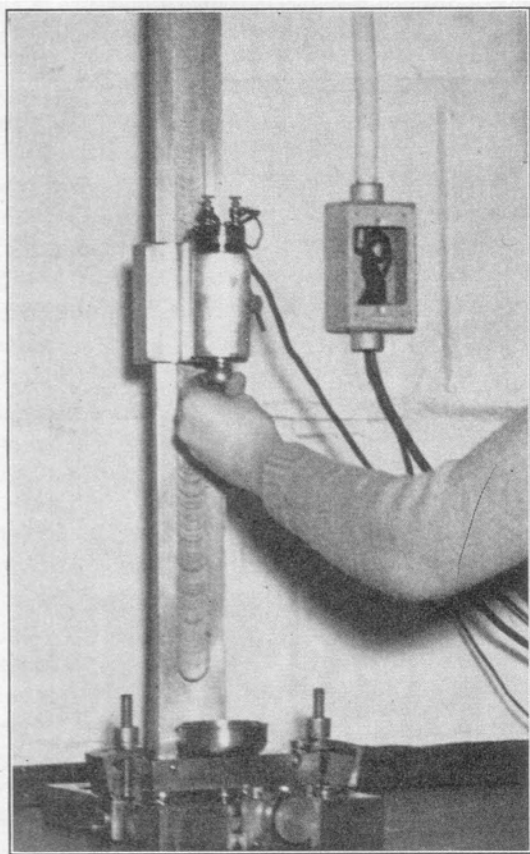

FIG. 14. Sensitivity drop-test machine.

Impulse is of interest for at least two reasons. It has long been considered that a primer used to initiate a delay column should have controlled impulse, as too little impulse might result in non-ignition and too much impulse might blow away part of the column at ignition and change the delay time. At least, igniting the column the same way every time with the same primer impulse is conducive towards uniformity of burning time. The other reason for measuring impulse is that almost a linear relationship exists between impulse and weight of charge, and impulse therefore serves as a control on charge weight.

3. **GAS VOLUME** is measured by the same apparatus (Fig. 15) as impulse. The mercury column is allowed to come to rest after the initial momentary displacement due to impulse. The steady-state displacement is a measure of gas volume.

Gas volume is of interest because it is also a measure of charge weight and is related to impulse. The ratio between gas volume and impulse

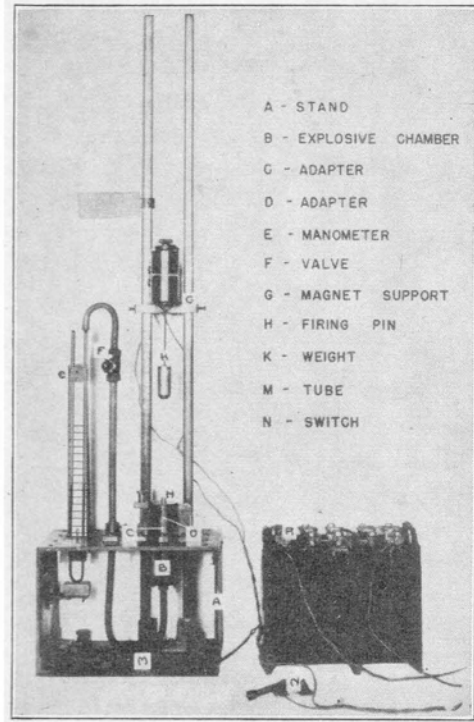

FIG. 15. Gas-volume- and impulse-testing apparatus.

serves to check on the actual charge composition, because if this ratio changes it means that the composition may have changed, whereas if this ratio stays about constant the variable is charge weight and not composition. Furthermore, gas volume is important when primers are used in obturated elements because the proper value as well as uniformity of gas volume is conducive towards uniformity of functioning of the obturated element, usually a delay column.

4. **Miscellaneous.** Among the other tests that may be performed if necessary but that are not performed in the routine acceptance testing of primers are the determination of the charge composition and weight and the flame characteristics.

5. Artillery Primers.

Description and Uses. AN ARTILLERY PRIMER is a device for igniting the propellant powder that imparts motion to a projectile. It may be a PERCUSSION PRIMER, which is fired by the action of the firing pin in the gun, an ELECTRIC PRIMER, fired by closing an electric circuit, or a FRICTION PRIMER, fired by drawing a serrated element through a friction composition. Artillery primers are located in the end of the cartridge case containing the propellant powder, or, if there is no cartridge case, in the breech of the weapon. Both percussion and electric primers for use in cartridge cases consist of an element containing a small quantity of sensitive explosive, and a charge of black powder, both encased in a long tube of brass or steel. Primers for trench mortar ammunition consist of a front-end percussion primer containing the sensitive explosive, and an ignition cartridge as a separate item. Artillery primers are sometimes called CANNON PRIMERS; they are a press fit in the cartridge case.

Percussion Primers.

1. General. A percussion primer is fired by the firing pin in the breech hitting a front-end primer element similar to a small-arms or fuze primer, the flash being transmitted to the black-powder charge. When a cartridge case is used, the tube containing the black powder is comparatively long in order to obtain complete ignition of the propellant powder; with no case, the primer charge need be only sufficient to ignite the black-powder igniter attached to the propelling charge.

The shape and length of the primer as well as the weight of the charge have much to do with the amount of flash and smoke resulting from firing. By combining a certain type of propellant powder and a certain type of primer for a certain weapon (which means a definite propellant charge, size of case, etc.), smoke and flash may be reduced to almost zero. In general, however, flash is reduced at the expense of increased smoke because flash indicates combustion and smoke indicates incomplete combustion, and the two tend to counterbalance. Furthermore, when a nice balance of minimum smoke and flash is reached in one weapon, the same primer and powder may not be flashless in another.

Primers are identified by the weight of their charge as well as by the usual nomenclature. A 65-grain primer has 65 grains of black powder back of the percussion element.

2. Construction and functioning. The construction of percussion primers is best understood by referring to Fig. 16, which shows various primers for artillery ammunition. They consist of a brass head into which fit the percussion element and a firing-pin-type plug. When the firing pin in the breech hits the plug, it is forced into the cup of the per-

ussion element, which flashes through a hole to the black powder contained in a long brass tube threaded to the head. The end of this tube

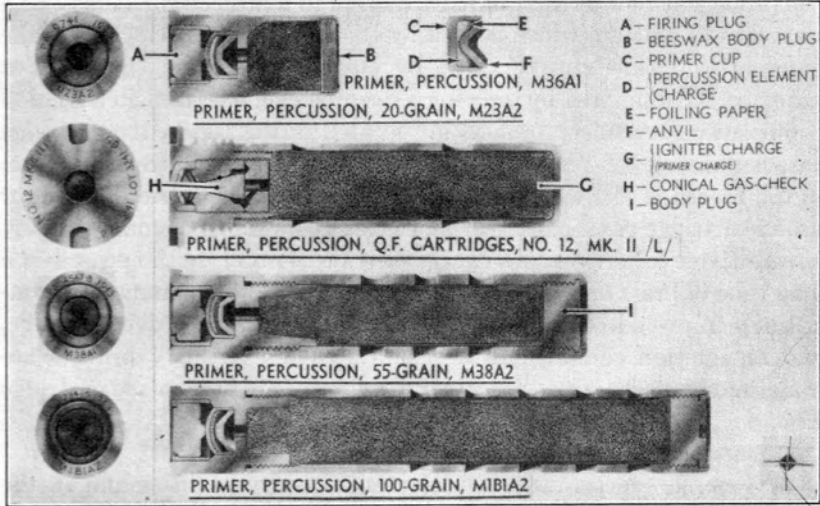

FIG. 16. Artillery percussion primers.

is vented to allow the flash to ignite the propellant powder over quite an area at one time, and is closed at the end by either a threaded plug or by using tubing with a closed end.

Originally these primers had charges occupying the entire length of the tube, but better characteristics were obtained in some cases by

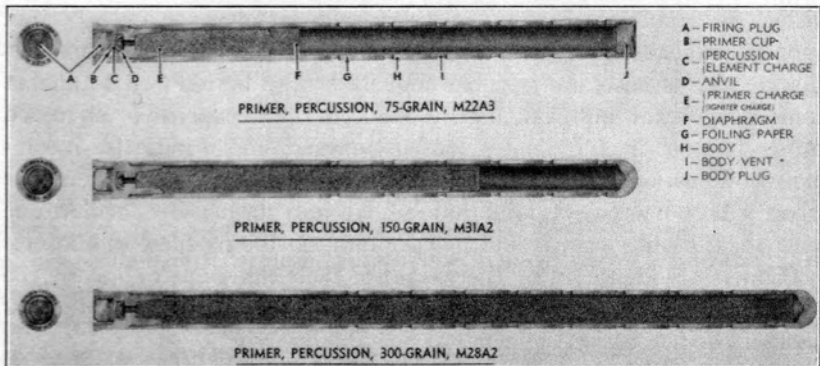

FIG. 17. Artillery percussion primers.

using less charge, retaining it with a cup, and allowing it to flash into the empty part of the tube and hit the holes, as shown in Fig. 17.

The holes are closed by an inside paper liner, and the entire primer body is dipped in acidproof black paint to protect the charge from moisture and to seal the entire primer.

Electric Primers. Large seacoast guns have an electric primer to ignite the propelling charge; a typical electric one is the M30 shown in Fig. 18. The explosive train is initiated by the heat developed by a

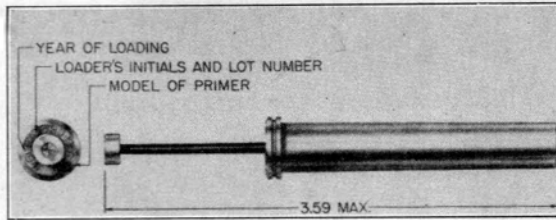

FIG. 18. M30 electric primer.

resistance ignition wire of platinum, the current being about 1.1 amperes, supplied by a hand-operated magneto. A small quantity of guncotton is placed around the wire, and 3 grains of loose black powder over the guncotton and extending into the 13.4-grain hollow black-powder pellet, which is followed by a 22.8-grain solid black-powder pellet. Extending from the head of the primer body is a long contact wire on the end of which is a button, and the current flows down the long wire to the platinum wire and out through the body of the primer, which constitutes the other terminal.

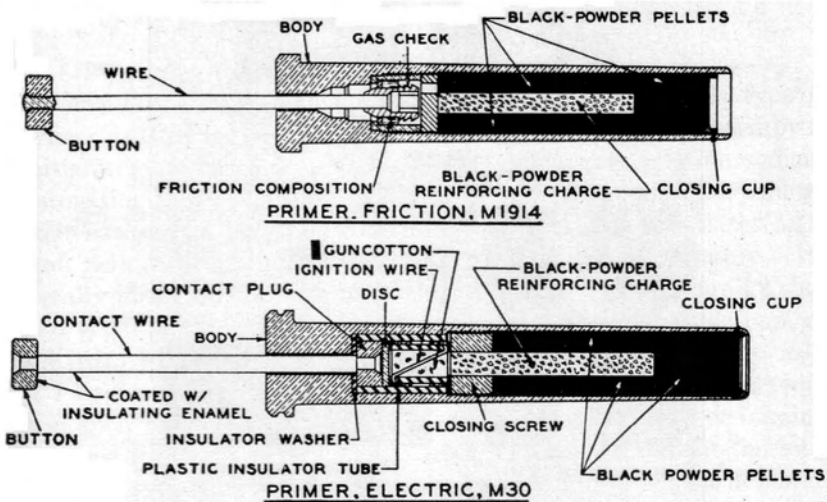

FIG. 19. Electric and friction primers.

A combination electric and percussion primer for certain seacoast guns is shown in Fig. 20.

Friction Primers. A typical friction primer is shown in Fig. 19; it is similar in construction to the electric primer M30 except that explosives

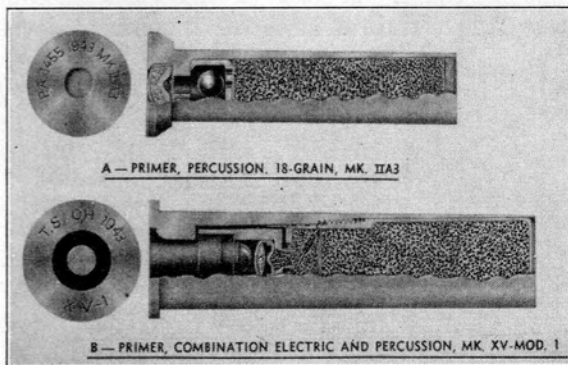

FIG. 20. Electric and percussion primers.

are initiated by the friction produced by drawing a serrated element through friction composition. Pulling the lanyard causes the long wire with the button on its end to be pulled back so that the serrated gas check ignites the friction composition, after which the gas check seats in the cone-shaped recess in the primer head.

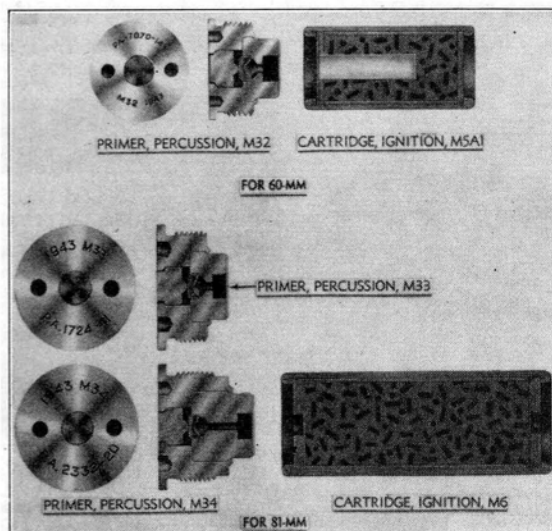

FIG. 21. Trench mortar primers and ignition cartridges.

6. Mortar Ammunition Primers.

Mortar ammunition is propelled by an ignition cartridge in the fin stabilizer tube, plus increments of powder around the tube, and both are ignited from a percussion primer element screwed in the end of the tube, which holds the ignition cartridge in place. A typical primer is shown in Fig. 21. It consists of an aluminum or steel head, brass firing plug, small-arms or fuze-type primer element, and a black-powder pellet, the last two items being contained in a steel housing crimped to the head.

DETONATORS

7. Definition and Description.

A DETONATOR is an explosive component for initiating a detonation in an explosive train or transmitting a primer impulse to the next element of the train, usually a booster. Detonators are comparatively small components, seldom over 1 in. long and $\frac{1}{4}$ in. in diameter, and they contain small amounts of the most sensitive initiator types of explosives such as lead azide or mercury fulminate in small cups of gilding metal or aluminum, depending upon whether the detonator is fulminate or azide type, respectively. Article 9 of this chapter discusses cup material in relation to the explosives used. The discs on the sensitive ends of all detonators should be sealed by red lacquer enamel or other suitable means for waterproofing. The tetryl end is sealed with a colored lacquer enamel for identification.

8. Types.

Three-Part Detonators (Primer Mixture Type). In this type the primer mixture is the first charge of the explosive train followed by the initiator material alone and by a tetryl charge to provide sufficient detonating force for transmission to the next element of the explosive train such as the booster. The three-part detonator is initiated by the stab action of a firing pin into the sensitive primer mixture. It is usually identified by a green disc on the tetryl end. Figure 22 shows two types of three-part detonators, one with a solid bottom cup, and the other with a disc at both ends of the cup.

Two-Part Detonators. This type contains either the intermediate and lower charges of the three-part detonator, either azide or fulminate followed by tetryl, or primer mixture and initiator without the tetryl. The first type of two-part detonator is initiated by the flame action of a primer ahead of it in the explosive train and transmits the detonation to the next element, usually a booster. It is identified by a yellow disc

on the tetryl end. The second type, Fig. 22, is initiated by firing-pin action, and is used primarily in the front end of standard point artillery fuzes for flashing down a channel to the first type of two-part detonator in the booster. The primer mixture type of two-part detonator is sealed red on both ends.

Two-part detonators for chemical fuzes consist of a plastic cup, usually with round bottom, containing azide followed by PETN, and

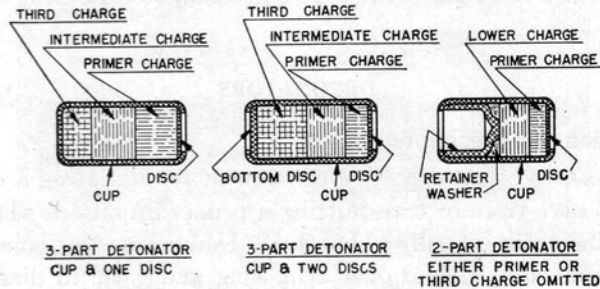

FIG. 22. Components of typical detonators.

they are initiated by a sulfuric acid mixture contained in a glass ampoule.

9. Explosive Materials.

Primer Mixtures. The primer mixtures in detonators are similar to those in primers, but in detonators they are followed by other charges directly below the primer charge.

Intermediate Charge. It is the INTERMEDIATE CHARGE that identifies a detonator. When we speak of an "azide detonator" we mean that the middle charge is lead azide. Mercury fulminate was formerly the middle charge in most detonators because of its extreme sensitivity, being several times more sensitive than the azide favored today, but fulminate is subject to deterioration under extreme conditions of temperature and humidity. Azide has replaced fulminate because of its greater stability, and aluminum cups in detonators have replaced the copper or gilding metal cups, with which the azide tends to react. However, when sulfocyanate primer mixture is used, gilding metal cups are necessary even with azide detonators because the sulfocyanate reacts with aluminum in a short time; the gilding metal cups are coated with shellac to prevent the reaction between azide and the gilding metal.

When azide is used, the height of charge is not too critical, but with fulminate a certain minimum height is required for initiation, about 0.18 in.

Third Charge. The last charge is almost invariably tetryl in the form of a reconsolidated pellet. After reconsolidation the end of the cup is crimped over a disc and sealed. Red lacquer is often used to seal the ends of detonators, but the red color has no significance as far as identification is concerned.

10. Properties and Testing.

Sand Test. In the SAND TEST the detonator is assembled in the prescribed testing fixture, Fig. 23, and initiated by a standard procedure.

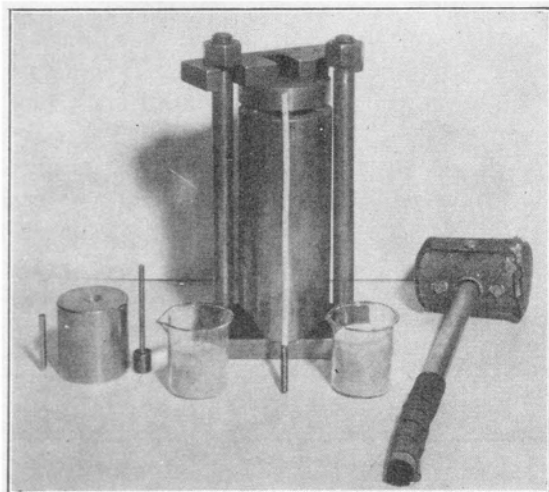

FIG. 23. Detonator sand-test equipment.

The detonator must crush a minimum amount of sand of a specified grade. This amount is a measure of the "force" or crushing action of the detonator and an indication of brisance. The test definitely distinguishes between a high- and low-order detonation. It is usually applied to detonators which are initiated by flame action rather than by the stab action of a firing pin.

Lead-Plate Test. In the LEAD-PLATE TEST the detonator is assembled in the prescribed testing fixture and initiated by dropping a ball of specified weight a certain distance on a specified firing pin. The detonator must function on the first drop of the ball and pierce the lead plate to not less than a required minimum diameter, Fig. 24. This test measures sensitivity, functioning, and also "force" in that it distinguishes between high- and low-order detonation. It is applied to detonators having primer mixture and is initiated by the stab action of the firing pin.

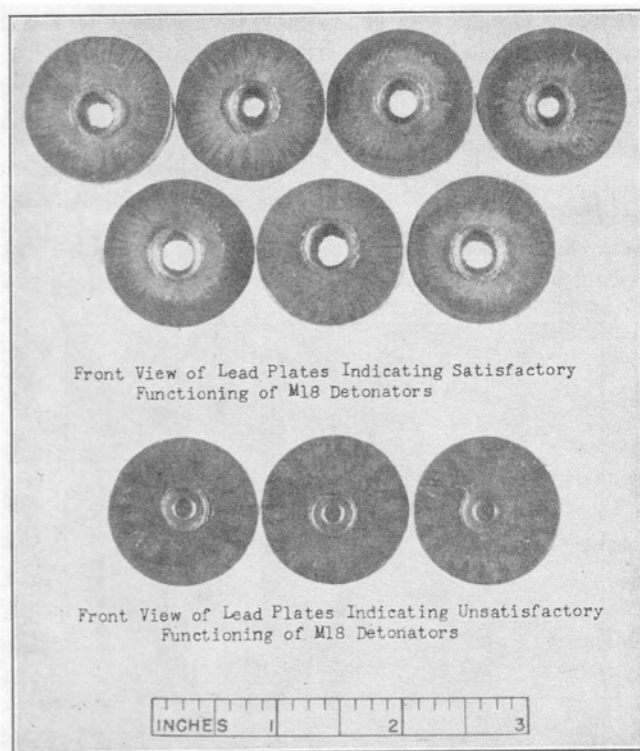

FIG. 24. Typical detonator lead-plate test results.

Waterproofness Test. Detonators that are required to be sealed are tested to determine the efficiency of the seal by immersing in 2 to 3 in. of water for a period of 48 hr., and then testing for functioning in the sand test or the lead-plate test, whichever is applicable. This test is important not only because some fuzes of the delay-action type may actually lie in water or marshy land and still be required to function, but also because many fuzes are stored in extreme conditions of temperature and humidity, as in the tropics.

Sensitivity Check Test. The tests mentioned merely test functioning under certain conditions without really testing the quality of the lot. In the discussion of primer sensitivity it was stated that the tendency is towards requiring a "run-down" test, which would really test the quality of detonators. A step in this direction has already been made the requirement of a so-called sensitivity-control test. In this test, a certain number of detonators are tested at a height of drop at which a

certain percentage of failures are expected (as determined by accumulated tests of production lots), and then only a certain additional percentage of failure is permissible. Thus, an attempt is made to establish one point on the run-down curve. This method of testing detonators shows much promise.

11. Commercial-Type Squibs and Detonators.

In addition to the military-type detonators described, certain commercial-type squibs and detonators are used in ammunition; they will be briefly discussed.

Squibs. The squibs used are of the electric type and are really igniters because they contain black powder or other deflagrating charge. The usual type consists of an aluminum tube about $1\frac{1}{2}$ in. long with the charge in the bottom of the closed end, with an electrical firing element in the form of a bridging wire, and two lead wires sealed in the open end with waterproofing compound. About 0.5 ampere is required to fire the squib, which ruptures with a flash to ignite the next element of the train: a black-powder charge, a slow-burning fuse, or a flash-initiated detonator.

Delay electric squibs are available; they vary in length from $3\frac{1}{8}$ to $5\frac{1}{8}$ in., depending on the delay.

Blasting Caps (Detonators). Commercial-type blasting caps are sometimes called detonators, but we will call them blasting caps to distinguish between them and the usual military detonators already discussed. There are two types, the non-electric, initiated by slow-burning fuse or detonating cord, and the electric, initiated by an electrical current of about 0.5 ampere. Both consist of a small, cylindrical copper capsule, closed at one end, and containing a detonating charge, such as tetryl. An ignition charge is sometimes used, in contact with the fuse or around the bridgewire, and a primer charge may be employed for detonation of the main charge. The primer material may function as all three charges. Blasting caps are also available in the instantaneous and delay types, the latter not being used to any extent in ammunition.

1. Non-electric blasting cap. Figure 25 shows a typical non-electric blasting cap, consisting of a capsule (*A*), charge (*B*), and plug (*D*), and crimped at (*C*) to detonating cord (*E*). Such a cap really acts as a booster in that it amplifies the impulse from the detonating cord and insures detonation of the next element in the train.

Commercial blasting caps are made in about ten sizes of different strengths, No. 6 being very popular ($1\frac{1}{2}$ in. long), and No. 8 also being

used (3 in. long). They are usually initiated by fuse, and therefore have an igniting and primer charge in addition to the main charge.

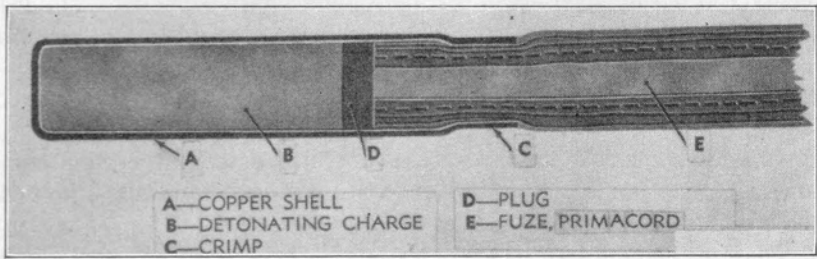

FIG. 25. Non-electric blasting cap.

2. Electric blasting cap. Figure 26 shows a typical electric blasting cap, consisting of capsule (A), charge (B), bridging wire (E), and sulfur waterproofing composition (G) around the lead wires (D). A loose igniting charge is placed around the bridging wire, followed by pressed primer composition and a tetryl main charge. The No. 6 commercial electric blasting cap is $1\frac{5}{8}$ in. long. The standard Corps of Engineers cap is somewhat longer.

Delay electric blasting caps, having a delay element between the electric firing element and the detonator charge, are available commercially.

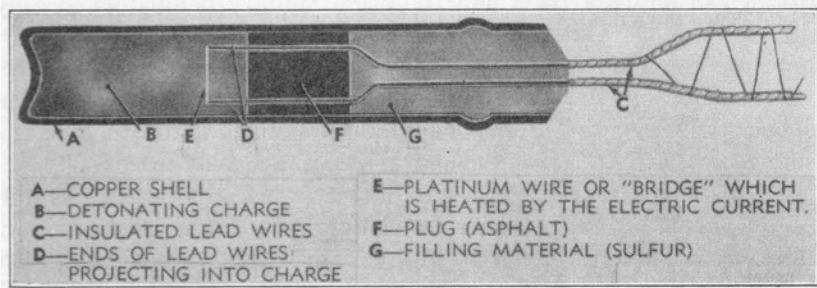

FIG. 26. Electric blasting cap.

TRACERS

12. General Description.

Some projectiles are designed so that they have a TRACER in the base for the purpose of directing fire. Such tracers burn for only a few seconds, seldom more than 10, and are visible both by day and by night. In base-fuzed armor-piercing projectiles of medium caliber, the tracer is in the rear of the base fuze itself, but its construction is the

same as that of tracers in projectile bases. Large-caliber armor-piercing projectiles may not have tracers because the time of flight and the range are so great that directing the fire by means of a tracer would not be practicable. In automatic fire, small-arms tracer bullets are mixed with armor-piercing and incendiary types; thus the direction of fire is controlled without loss of the effectiveness of other types of ammunition.

The length of time of the trace depends upon the result to be accomplished. For direction of armor-piercing projectile fire, where ranges are comparatively short, a time of 3 to 4 sec. is sufficient. For aircraft and antiaircraft shell, where the range is longer, a time of 6 to 10 sec. is desirable in order that the projectile may be traced until it hits or misses the moving target. Tracers which perform the function of destroying the shell at the expiration of the trace time as well as providing a means of fire control are called SELF-DESTROYING TRACERS. Tracers of present design are ignited by the propellant-powder gases when the round is fired. The British have a tracer containing a plunger setback element that ignites a primer on setback, thus igniting the tracer composition.

13. Projectile Tracers.

Screwed-In Type. This type of tracer is a separate component screwed into the projectile after it is loaded. Figure 27 shows examples of screwed-in tracers, (a) being the British No. 12 Mk I/L/ and (b) being the Navy type similar to the M3 which is used in 40-mm. antiaircraft ammunition. This latter type consists of an igniter increment and two tracer increments all pressed at about 100,000 lb./sq. in. The igniter composition consists of barium peroxide and magnesium and aluminium powders. The tracer composition contains strontium nitrate and ammonium perchlorate as oxidizers and to give color, magnesium as a fuel, and a small amount of carnauba wax as a binder. The tracer is sealed against moisture by a gilding metal disc held in place with a steel washer having a 360° crimp to the shell body.

At the expiration of tracer burning, about 6 sec., the tracer ignites the black-powder relay charge in the steel relay housing. The type shown in Fig. 27(b) has a small-diameter relay charge ignited by the heat of the tracer passing through the end of the housing. Obturation of the relay is therefore obtained, and as the relay burns the increase in pressure aids the black powder burning to insure the functioning of the shell filler.

Certain larger-caliber AP shot, like 90-mm. and above, sometimes have a screwed-in tracer consisting of the direct-base type of tracer in a

separate component in order to facilitate loading, the tracer component then being screwed in the end of the shot.

Direct-Base Type. This is the simplest type of tracer, the composition being loaded directly into a cavity in the base of the shell. The 37-mm.

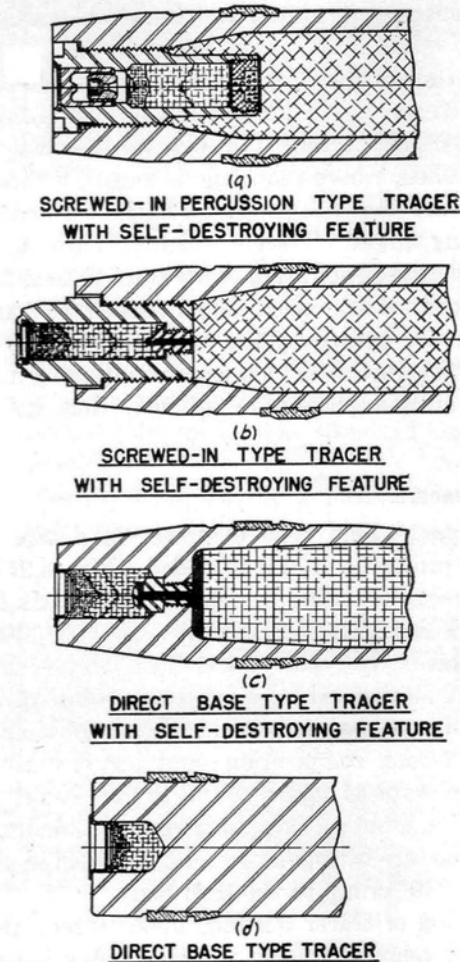

FIG. 27. Various types of tracers.

M54 antiaircraft shell tracer is an example of this type, as shown in Fig. 27(c). The composition is pressed at 110,000 lb./sq. in.; it consists of strontium nitrate to give color, magnesium as a fuel, calomel as a color intensifier, and asphaltum as a binder, and is known as red tracer composition. The igniter, called "K" composition, consists of barium

peroxide, magnesium, and asphaltum. Closure is by a gilding metal cup expanded into the end of the cavity or by a disc over which a steel ring is placed and crimped 360° to the shell body, the latter type not being used with AP shot because of the difficulty of crimping the hard metal of the shot base to the ring. The relay is screwed in ahead of the tracer and is loaded with black powder. Burning time is also about 6 sec., as this is another antiaircraft projectile tracer and is of the self-destroying type. The relay is ignited directly by the tracer composition rather than by heat transfer, and, since this method does not give obturation, a black-powder pellet is pressed in the base of the shell covering the entire bottom of the cavity to assist in the functioning of the shell filler. The direct-base type with shell-destroying feature is also used in 20-mm. aircraft and antiaircraft ammunition.

Another type of tracer loaded directly into the base of the shell, but lacking shell-destroying feature, is shown in Fig. 27(d). The burning time is 3 to 4 sec., sufficient for the direction of AP fire against tanks at the ranges used with 57-, 75-, and 76-mm. and 3-in. shot. Closure is by means of a gilding metal disc.

Percussion Type. The British No. 12 Mk/L/, Fig. 27(a), is also an example of a tracer not ignited by the propellant gases but by an inertia element built into the tracer body. On setback, this element containing a primer moves back against a fixed firing pin, the flash from the primer igniting the tracer which then burns through to the relay and shell charge. The percussion type of tracer is not used in American ammunition at the present time.

Small-Arms Types are discussed in Chapter 4.

14. Fuze Tracers.

The M66, M68, and M72 fuzes and the 75-, 90-, and 57-mm. AP shell, respectively, have a tracer element almost identical to that shown in Fig. 27(d) similar to the direct-loaded AP shot tracer. The burning time is 3 to 4 sec. as the tracer is for the direction of AP fire, and the composition and closure are the same as described.

PART II
SMALL-ARMS AMMUNITION

CHAPTER 4

SMALL-ARMS AMMUNITION

1. General.

SMALL ARMS are weapons used by individual soldiers and as aircraft and tank armament. Although small arms have always been associated with the infantry, they are now used by other branches as well, especially those in combat, and not the least of these are the Air Forces, who use machine guns as a major part of aircraft firepower, and paratroopers, who use pistols, rifles, and machine guns. Members of the Corps of Engineers, the Ordnance Department, and similar units use small arms for their personal safety as well as in combat when conditions require. Even the artillery employs small arms to a limited extent, and nothing gives the individual soldier of any branch or unit more sense of personal safety than his own caliber .45 pistol or his caliber .30 rifle.

Small arms include rifles, semi-automatic rifles, automatic rifles, pistols, revolvers, machine guns, submachine guns, shotguns, carbines, etc. They will not be discussed here, as we are interested in the ammunition for these weapons. The distinguishing feature of all these weapons is that the bore does not exceed 0.60 in. in diameter, and **SMALL-ARMS AMMUNITION** is defined as ammunition fired in weapons whose bore is 0.60 in. or less. Shotgun shell are an exception to this definition.

2. Caliber and Nomenclature.

The caliber of small-arms ammunition, except shotgun ammunition, is expressed as the diameter of the bore of the weapon, in inches. Thus caliber .30 ammunition is intended for a weapon having a bore of 0.30 in. diameter across the lands, and, although the outside diameter of the bullet is a few thousandths of an inch greater than the bore diameter, it is customary to speak of this ammunition as caliber .30 ammunition.

The gage of a shotgun is expressed as the number of lead balls of the diameter of the bore required to weigh 1 lb. Thus, a 12-gage shotgun has a bore diameter of 0.785 in. because 12 lead balls of 0.785-in. diameter weigh 1 lb.

The usual sizes of present-day small-arms ammunition are calibers .22, .30, .45, .50, and .60, and 12 gage, consisting of ammunition for the caliber .22 pistol and rifle, and machine gun (gallery practice only); caliber .30 carbine, rifle, semi-automatic rifle, automatic rifle, and machine gun; caliber .45 pistols, revolvers, and submachine guns; and calibers .50 and .60 machine guns.

Small-arms ammunition follows the same system of nomenclature as other ammunition, most of it being designated in the M series, and a few rounds still being designated in the M series followed by the year.

The complete round of small-arms ammunition is called a CARTRIDGE. For example, the complete round of caliber .30 ball ammunition is described as Cartridge, Ball, Caliber .30, M-2.

3. Classifications of Small-Arms Ammunition.

Compared to artillery, aircraft, and rocket ammunition, the number of sizes and types of small-arms ammunition is small. The principal types are as follows:

BALL AMMUNITION, consisting of a lead core with a gilding metal or gilding-metal-clad steel jacket, and intended for use against personnel and material targets not requiring armor-piercing or other special ammunition. This was formerly the most common type, known simply as a "small-arms bullet." It may also be used for gun functioning and training.

ARMOR-PIERCING AMMUNITION (AP), consisting of a hardened-steel core behind a lead point filler, inside a gilding-metal jacket, for use against enemy aircraft, lightly armored vehicles, concrete shelters, etc., and generally replacing ball ammunition for combat use.

TRACER AMMUNITION (T), similar to ball ammunition, but having the rear portion of the slug replaced by tracer composition for observation and control of fire, incendiary work to a limited extent, and signaling.

INCENDIARY AMMUNITION (I), for the specific purpose of instituting conflagrations by means of the incendiary composition it contains; it is used primarily against aircraft as a means for setting fire to enemy planes.

ARMOR-PIERCING INCENDIARY AMMUNITION (API), having the lead point filler replaced by incendiary composition, primarily for use against aircraft.

ARMOR-PIERCING INCENDIARY TRACER (API-T), similar to API but having a tracer in the rear of the bullet.

BLANK AMMUNITION, consisting of a powder charge in the cartridge case, without bullet, and used for signaling, saluting, or simulating fire.

DUMMY AMMUNITION, completely inert ammunition without primer or propelling charge, used for training.

GUARD AMMUNITION, similar to ball ammunition, but containing a reduced propelling charge, used for guard purposes, where long range and high velocity are not required.

HIGH-PRESSURE TEST AMMUNITION (HPT), similar to ball ammunition, except employing a heavier bullet and containing an excess propelling charge for the purpose of developing pressures in weapons higher than normal, for proof-testing weapons from a fixed rest, under a hood, and with the trigger released mechanically.

RIFLE-GRENADE AMMUNITION, used to fire rifle grenades, and consisting of a special cartridge case loaded with powder but without bullet.

SUBCALIBER AMMUNITION, having a rimmed cartridge case for firing from sub-caliber tubes, principally the tube in the 3-in. gun.

SHOTGUN SHELL, usually purchased from commercial concerns, and consisting of a propelling charge, load of lead shot, and primer all in the same case. They are used for guard work, hunting, trap and skeet shooting, and in jungle warfare.

4. Uses.

The caliber .30 carbine, rifles, and machine guns and the caliber .45 pistol and submachine gun are used in combat by the infantry or other branches of the Army as fundamental essential ground combat weapons. The calibers .50 and .60 machine guns are antiaircraft and aircraft weapons, and may also be used as ground machine guns. The caliber .22 pistol and rifle and the 12-gage shotgun are used for practice and sporting purposes and sometimes in combat.

The solid bullet known as ball ammunition which was popular for small arms in World War I, has been replaced to a large extent by the armor-piercing types, which are just as effective against personnel as ball ammunition and have armor-piercing properties due to the hard-steel core which replaces the softer lead core. For machine guns at high rates of fire, it is desirable to direct the fire by tracers, and tracer ammunition is mixed with armor-piercing ammunition.

Although armor-piercing ammunition is effective against aircraft, it has been found that incendiary ammunition is equally if not more effective because of the vulnerability of aircraft to fire on account of gas tanks, oxygen-supply tanks, fuel and oil lines, etc. In fact, the armor on a plane is never so thick but that it can be penetrated by high-velocity calibers .50 and .60 armor-piercing ammunition, and it has been found practical and effective to sacrifice some of the armor-piercing effect in order to gain some incendiary effect. This accounts for the popularity of the API bullet, which is mixed with tracer bullets in the belt or with the API-T bullet if available. Even the API-T bullet with the front of the core removed for the incendiary mixture, and some of the rear of the core removed for the tracer, is still a good armor-piercing bullet. In fact, the armor-piercing qualities of the API bullet are just about the same as the straight AP bullet, according to recent tests.

The caliber .30 machine gun is becoming essentially a ground weapon, inasmuch as most aircraft now require and can carry at least a caliber .50 machine gun. Armor-piercing ammunition with or without incendiary is effective against the usual ground targets, such as personnel in the open or protected by light barricades, trucks and vehicles with vulnerable gas tanks, etc. Tracer ammunition may be mixed in for fire control.

From this discussion it is apparent that the three fundamental combat types of small-arms bullets are armor-piercing, incendiary, and tracer, and that they are used in various combinations.

5. Hangfire.

In artillery fire the round either fires almost instantly or misfires completely. By "almost instantly" we mean no more than a few milliseconds after the primer is struck or the electric circuit closed, or the lanyard pulled. Actually it would not make any difference if the round fired a tenth of a second later.

There are applications in small-arms fire where such a small delay or HANGFIRE would be disastrous. In automatic fire at a high rate, it is essential that each round fire instantly and that all rounds be uniform so that there will be no interruption of the automatic fire. Ammunition for synchronized aircraft machine guns must be particularly uniform and free from any hangfires, as part of the propeller may be blown off by hangfire. In fact, it was only because small-arms ammunition could be made so uniformly and without hangfires that its application to synchronized fire was possible. Although a small-arms cartridge is not as complicated as an artillery round, it is still a remarkable feat to be able to guarantee that the primer, propellant powder, and bullet will all function instantly, and still manufacture such cartridges by the millions (maximum size of one lot is 2,000,000) by mass-production methods.

It is therefore necessary that small-arms ammunition of the sizes and types for aircraft machine guns be subjected to a hangfire test and to require that if a particular lot does not pass this test it be earmarked for other than aircraft use (see Art. 6). This test usually consists of firing bursts of 75 rounds at 450 rounds per minute through a disc rotating at 1800 revolutions per minute, the grouping being measured in degrees from the leading edge of the shot nearest the zero mark. For aircraft use the grouping must not exceed 15°. When tested in the electrostatic hangfire machine, the time corresponding to this value is 0.0014 sec.

6. Grades of Small-Arms Ammunition.

In addition to the hangfire limitation, there are other requirements for uniformity of functioning of small-arms ammunition. Remote-control aircraft machine guns, either synchronized for firing through the propeller or not, must be uniform and free from jamming, failures to extract the empty case, failures to chamber, and any other defects causing interruption of automatic fire. Rifle ammunition must have a certain degree of uniformity, such as uniform extraction effort. Bullet pull (force required to pull the bullet from the case) must be controlled within reasonable limits to prevent debulleting and erratic ballistics. Despite the uniformity of modern mass-production methods, some variations do occur, and careful inspection is necessary.

Because different small-arms weapons require ammunition of different degrees of perfection it is customary to assign a GRADE to each lot of calibers .30 and .50 ammunition, the grade being determined by conducting acceptance tests. The grades thus assigned are grade A, for ammunition for aircraft machine guns, and grade B for all other purposes. Although all small-arms ammunition must pass certain tests the requirements for grade A ammunition are more severe than those for grade B. A lot of ammunition once offered as grade A ammunition and rejected may not again be offered as grade A even though it may have been reworked or reinspected, but it may be offered as grade B. Of course ammunition offered as grade B may be reworked or reinspected and again offered as grade B. Thus the quality of small-arms ammunition for aircraft and ground purposes is controlled.

Once manufactured and stored, small-arms ammunition may be further graded by the Field Service, such factors as conditions under which stored, quality as determined by sample firing at various times during storage, and, of course, the assigned grade as manufactured being taken into account. For this grading, the designations for the various small-arms weapons are:

Aircraft machine gun	AC
Aircraft machine gun or rifle	AC or R
Rifle	R
Ground machine gun	MG
Unserviceable	3

Note that AC or R is in itself one designation. These designations are also called grades but are not to be confused with the grades (A and B) assigned at the completion of manufacture.

Table 8 shows the grades (designations) authorized for calibers .30 and .50 weapons. Substitutions are authorized by Field Service depots and in the field.

TABLE 8

DESIGNATIONS OF SMALL-ARMS AMMUNITION

Weapon	Caliber .30	Caliber .50
Aircraft machine guns	AC; AC or R	AC
Antiaircraft machine guns	AC; AC or R; MG; R	AC; MG
Rifles, semi-automatic rifles, and automatic rifles	R; AC or R
Ground machine gun	MG; R; AC or R; AC	MG; AC
Unserviceable	3	3

When two or more grades are authorized for a weapon, it is desirable to use the ammunition in the order shown. Thus, for the caliber .30 aircraft machine gun, AC is preferable, but AC or R (one grade lower) can be used. For .30 caliber rifles, R is preferable because it is quite satisfactory, but a better grade, AC or R, can be used. Although MG is quite satisfactory for both calibers .30 and .50 ground machine guns because of rugged construction, continuous control exercised by the operators, and lower rate of fire, AC can be used but it is a better grade of ammunition than is actually required. In other words, Table 8 shows down grading for aircraft and antiaircraft machine guns, because the best grades are required, the use of lower grades representing a compromise, and up grading for rifles and ground machine guns because there is no need of firing grades better than required, though they can of course be employed.

Caliber .45 ammunition is graded only as grade 1 for revolvers, pistols, and submachine guns; grade 2 for pistols and submachine guns only; and grade 3 as unserviceable.

7. Inspections and Tests.

During the course of manufacture and acceptance of small-arms ammunition, certain inspections and tests are conducted. It is not intended to discuss here inspections and testing in general but only to list some of the usual ones, so that the ammunition designer may know the requirements which his design must meet.

Inspections. The usual types of inspections are classed as visual, gaging, and weight check. Visual inspection includes examination of the complete cartridge for discoloration, corrosion, dirt, etc.; examination of the cartridge case for dents, splits, scratches, wrinkles, bulges, etc.; examination of the bullet for dents, scratches, exposed core, loose bullets,

etc.; and examination of the primer to determine if it is cocked, inverted, loose, poorly crimped, etc.

Gaging is performed on the cartridge, case, bullet, and primer to check dimensions. Complete cartridges are checked to ascertain that the weight is within the tolerances allowed. Of course all drawing and specification requirements must be met, and proper inspection and gaging must be performed for that purpose.

Tests. Certain tests are also performed for acceptance, and the designer must keep these in mind during the course of development of a new small-arms cartridge or bullet. The following tests and requirements are common to most all types of small-arms cartridges.

1. **BULLET PULL** is the load required to separate the bullet from the cartridge case; it is a measure of the uniformity and efficiency of the crimp of the case to the bullet. The caliber .30 M2 AP bullet-pull requirement is 45 lb. minimum, and 50 rounds are subjected to the test.

2. **MERCURY CRACKING** is a test of brass cartridge cases to ascertain whether they are subject to cracking. Fifty rounds are selected, and half are fired in the weapon. Then the cases for the entire 50 are pickled in nitric acid solution, rinsed in water, submerged for 15 minutes in a solution of mercurous nitrate and nitric acid, and examined for cracks and splits.

3. **Velocity.** Twenty rounds are fired to check the velocity, and since velocity is measured by checking the time required for the round to travel a certain base distance, usually from 3 to 153 ft. in front of the muzzle, velocity is given at a certain distance from the muzzle, usually 78 ft. This practice differs from that of artillery ammunition, as velocities are usually corrected back to muzzle values in artillery. They may be corrected back to muzzle values for small-arms ammunition, but it is customary to state the velocity at 78 ft. The caliber .30 M2 AP cartridge is required to have a basic velocity of 2715 ft./sec. at 78 ft. (with the requirement that the mean of 20 rounds may not be more than ± 30 ft./sec. from this basic figure).

4. **Pressure.** Twenty rounds are also fired to check maximum chamber pressure, and the average for the caliber .30 M2 AP round is required to not exceed 54,000 lb./sq. in. The specification for the powder also states the maximum pressure that must not be exceeded.

5. **Waterproofness.** In order to compare the average velocity of the 20 rounds tested in 3, above, with the velocity of 20 rounds submerged in $1\frac{1}{2}$ in. of water for 24 hr., a waterproofness test is conducted. The average velocity of the submerged cartridges may not vary from the average velocity of the dry ones by more than 100 ft./sec.

6. **Accuracy.** A test for accuracy of firing is conducted by firing 90

rounds total in bursts of 10 rounds each through a Kraft paper target at 600 yd. range. Each burst is laid out with lines representing the extreme horizontal and vertical locations of the holes, and a mean radius is determined. The requirement for the caliber .30 M2 AP round is that the average of the mean radii for all the bursts (targets) shall not exceed 10 in. This test is conducted with an accuracy barrel mounted in a special accuracy rest.

7. Hangfire. The importance of a hangfire test has been described in Art. 5. The hangfire test is usually conducted by firing 600 rounds in bursts of 75 rounds each at a disc rotating at 1800 r.p.m. The grouping may not exceed 15° and 27° for grades A and B, respectively. When the test is conducted in the electrostatic hangfire machine, the corresponding times are 0.0014 and 0.0025 sec., respectively.

8. Functioning and casualty. For checking cartridge functioning in the weapon, from 100 to 500 rounds are fired, depending on the weapon, to check for bullet remaining in bore, cartridge case casualty, failure to extract, failure to chamber, etc.

In addition to these tests performed on all types of rounds, certain types require special tests to check functioning. The most important of these are:

9. Penetration. Armor-piercing-type cartridges (AP, API, API-T) are tested for penetration by firing against homogeneous plate of about 400 Brinell hardness at not over 5° from the normal to the plate. The requirement for the caliber .30 AP M2 cartridge is that the average depth of penetration of the cores of 40 cartridges be not less than 0.42 in. at 100 yd. This represents penetration of almost 2 calibers, since the core diameter is somewhat less than 0.30 in.

10. Tracer. Tracer cartridges are tested for observation of the length, brilliancy, and general satisfactoriness of the trace. Caliber .30 ammunition is expected to trace for about 1200 yd., and caliber .50 ammunition about 1800 yd. A long trace of 2500 yd. has been developed for caliber .50 ammunition and a dim trace (dim for first 200 yd. to prevent dazzling of the gunner) has also been developed for caliber .50 ammunition.

11. Incendiary. Incendiary bullets are tested by firing against a target simulating an aircraft structure, and rating the incendiary flash, both in volume and location, against a standard chart.

All together, some 2500 cartridges may be consumed in conducting the various tests for a given lot of ammunition of one type.

8. Ballistics and Stability.

For effective use of small arms, a flatter trajectory is desirable than is sometimes required by artillery fire. Furthermore, we are usually not

interested in that part of the trajectory which curves down to impact with the ground. Small-arms weapons are fired at short ranges, seldom more than 1000 yd., usually less, at targets which can be seen by the unaided eye. The soldier does not fire at targets he cannot see or at those he does not have a reasonable chance of hitting. The aircraft gunner fires at even shorter ranges, seldom over a few hundred yards. Maximum range does not have the significance in small-arms fire it has in artillery fire.

Setback. Only some general comments will be made regarding this interesting and complicated subject. The small-arms bullet is fired with a high velocity, over 2000 ft./sec. except for bullets of calibers .22 and .45. Bullets of calibers both .30 and .50 are fired at 2700 to 3000 ft./sec. The chamber pressure for calibers .30 and .50 weapons is about 50,000 lb./sq. in. The setback for a caliber .50 bullet weighing 700 grains and fired at 3000 ft./sec. is, from equation 20, Art. 11, Chapter 6,

$$\frac{50,000}{700} \frac{\pi}{16} = 13.8 \text{ lb./grain}$$

which is very high compared to the usual setbacks of artillery projectiles which seldom exceed 3 lb./grain but may be as high as 10 lb./grain. However, small-arms bullets are strong compared to their size, and setback stresses are usually not computed in bullet design unless there is some reason for doing so. For example, during the development of an incendiary bullet containing incendiary mixture inside a steel sleeve in the front cylindrical portion of the bullet, it was found that the bullet bulged as the result of setback of the steel sleeve against the rear lead filler. Lead with more resistance to deformation was used after the bearing pressure due to setback had been calculated.

Rotation. The twist of rifling is about the same as in artillery weapons, being 1 turn in a length of 33 calibers for caliber .30 weapons, 1 in 30 for caliber .50 weapons, but only 1 in 60 for the caliber .30 carbine. The speed of rotation at the muzzle may be computed from formula 1 the same as in artillery-projectile design. For the caliber .30 ball bullet fired at 2740 ft./sec. in the 1 in 33 twist weapon, the speed of rotation at the muzzle is:

$$\frac{2740 \times 720}{33 \times 0.30} = 200,000 \text{ r.p.m.}$$

which is approximately 10 times more than the rotation of a 37-mm. artillery projectile. In the design of small-arms bullets, therefore, considerable care is required to insure that the jackets are sufficiently

strong to withstand the centrifugal stresses tending to strip the jacket from the core.

Stability. Since the bullet is not expected to nose over and curve downward to a nose impact with the target, higher stability factors may be used than in the design of artillery projectiles. They are determined the same way, from formula 13 and from firings. The usual factor varies from 1.5 to 4.0, being 3.4 for the caliber .30 ball bullet, much higher than is usually desired in artillery-projectile design, except for armor-piercing projectiles where the usable trajectory is flat. The factor for the caliber .30 carbine is over 12, despite the 1 in 60 twist, because of the abnormally high ratio of axial to transverse moments of inertia. The lowest factor for any small-arms bullet of standard design is about 1.4. These stability factors will be reduced when firing forward from aircraft since the velocity of the bullet with respect to air is increased without a corresponding increase in angular velocity.

The yaw (see Chapter 5) is usually less than 5 or 6°. Since yaw outside the weapon is usually 20 or 30 times that in the weapon, the clearances and tolerances must be kept to a minimum. In general, the principles of small-arms ballistics are the same as for artillery projectiles. The Ballistics Research Laboratory at Aberdeen, Maryland, provides ballistic data.

9. Bullet Design.

The modern small-arms bullet is an accurately made projectile, designed for a specific purpose such as penetration of armor, incendiary effect, or antipersonnel effect. It must function at the target at all temperatures between -65 and $+170^{\circ}$ F., and it must withstand storage under all conditions. It has no fuze, rotating band, or bourrelet, but otherwise the same design principles apply as in designing artillery projectiles. Figure 29 shows an armor-piercing cartridge; parts of the bullet are clearly shown and will be discussed. Other types of bullets may be considered as variations of the AP type.

General Construction. The AP bullet consists of a gilding-metal JACKET, surrounding a tungsten-chrome or manganese-molybdenum steel CORE, with a POINT FILLER (90% lead, 10% antimony) in the NOSE. About one-third of the length from the base end is a machined annular groove called a CANNELURE, for the purpose of crimping the cartridge case to the bullet. The jacket is crimped around the core at the base. The bullet has no bourrelet like artillery projectiles, but the entire length of the cylindrical portion of the bullet is engraved by the rifling and therefore acts to impart rotation, as does the rotating band of the artillery projectile. The taper at the rear of the bullet is called the BOATTAIL.

Nose. The nose of a small-arms bullet is fairly pointed, with a contour similar to that of the artillery shell with its fuze. The width of the

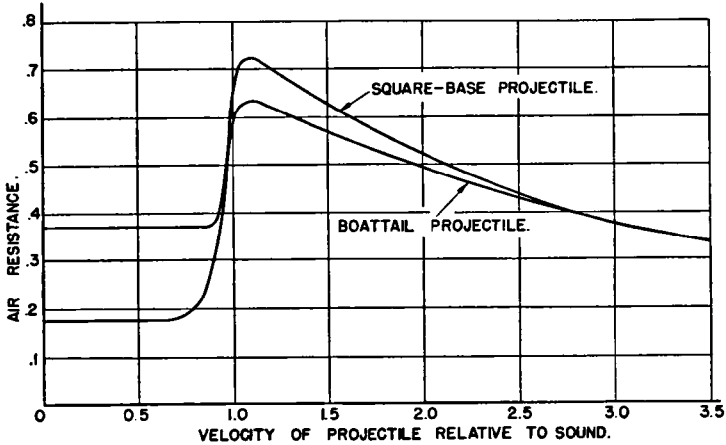

FIG. 28. Effect of boattail on air resistance for artillery projectiles.

point, called the meplat, is kept small to reduce air resistance and increase effective range. It is quite true, especially of aircraft fire, that much small-arms ammunition is fired at point-blank range, at targets

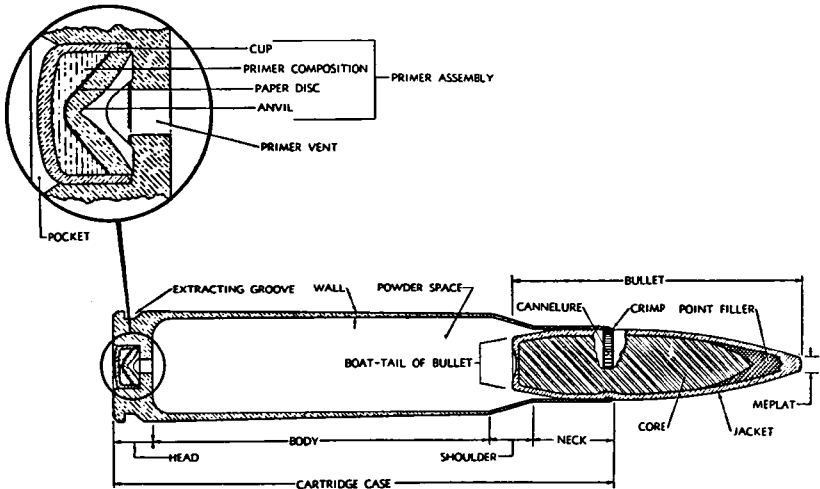

FIG. 29. Components of small-arms cartridge.

seldom more than 500 yd. distant. But for sniping and other requirements of rifle fire, maximum effective range may be a factor, and the

nose must be correctly designed. Caliber .30 bullets usually have a 7-caliber radius of ogive, and caliber .50 bullets have a 9-caliber radius of ogive.

Boattail. The fundamental consideration of boattail design as applied to projectile design is that the boattail is beneficial and desirable primarily at velocities below about 2900 ft./sec. This principle applies to small-arms bullets as well as to artillery projectiles; it is illustrated in Fig. 28. The trajectories of square-base and boattailed projectiles fired at more than 2900 ft./sec. are almost identical, whereas at velocities below this figure the boattail is beneficial. It becomes increasingly beneficial down to the local velocity of sound, and at subsonic velocities it is even more beneficial. The ratio of the drag of the square-base projectile to that of the boattail projectile is high below the velocity of sound, because the air flow is smoother around the boattailed projectile. Obviously, at lower velocities the air currents follow the projectile contour better than they do at higher velocities, and this fact accounts for the greater beneficial effect of the boattail at lower velocities. The small-arms bullet boattail is usually 9°.

Penetration. The usual targets for small-arms armor-piercing type cartridges (AP, API, API-T) are light vehicle armor, aircraft armor, gasoline tanks, etc. Although small-arms ammunition is ineffective against such artillery targets as tanks, concrete fortifications, etc., the penetration is very important, because the principal target is the plane, which seldom has armor more than 1 in. thick. Penetration of aircraft armor alone without some incendiary effect is usually not sufficient to bring down a plane, and that is why the recent tendency is to attempt to retain AP effect, and at the same time increase incendiary effect, as is done in the design of API bullets.

The AP bullet has a lead point filler, as shown in Fig. 29, just ahead of the tungsten-chromium or manganese-molybdenum hard-steel core, which performs a function similar to the cap of AP artillery projectiles in initially stressing the plate and supporting the core so that the core can have a better chance of penetrating without breaking up. Penetration of $1\frac{1}{2}$ to 2 calibers is expected from the AP bullet. Theoretically API bullets have less penetration not only because the lead point filler is omitted but also because the core is reduced in length and mass to provide space for the incendiary composition in the nose. But recent tests show that the API bullet is just about as effective as the AP bullet for armor penetration except for extremely hard plates.

Incendiary Bullets. The two general types of incendiary bullets are those derived from ball bullets and those derived from armor-piercing bullets. The former was developed first as the need for an incendiary

bullet for aircraft and antiaircraft arose. The latter was developed when the need for a combination armor-piercing and incendiary bullet became apparent, at the same time when armor-piercing bullets replaced ball bullets for aircraft and antiaircraft use.

The straight incendiary bullet has an incendiary charge in the nose and in a steel sleeve ahead of the lead slug. The API bullet is similar

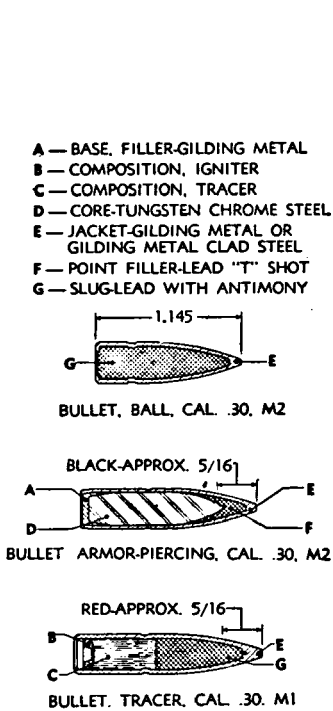

FIG. 30. Caliber .30 small-arms bullets.

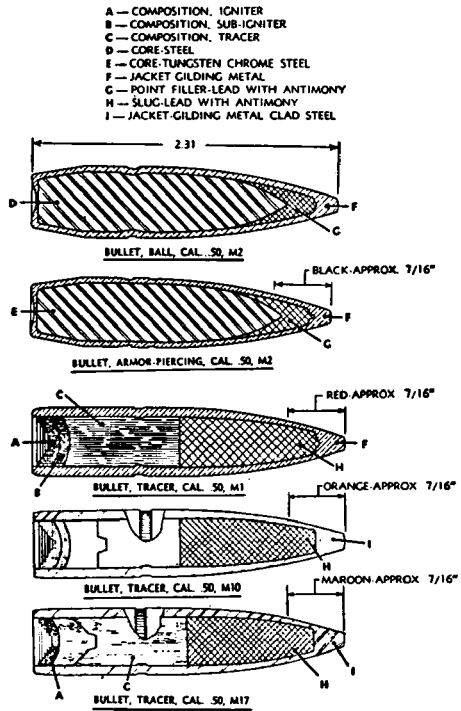

FIG. 31. Caliber .50 small-arms bullets.

except that the incendiary is ahead of the steel core. The caliber .50 API bullet contains 15 grains of the usual incendiary mixture (barium nitrate and aluminum-magnesium powder).

All incendiary bullets function on impact, the mixture being ignited by the sparks and heat of impact. The gilding-metal jacket is torn open, and the incendiary burning time is about 10 to 40 milliseconds, depending upon velocity of impact, conditions at impact, etc.

A more effective incendiary bullet is the caliber .50 M23, which is a 500-grain bullet fired at 3400 ft./sec. It is used where greater incendiary effect is required.

Tracers. There are two types of small-arms tracer bullets, those derived from ball bullets, and those derived from armor-piercing bullets. The former have the rear half of the lead core replaced by the igniter and tracer composition, as shown in Figs. 30 and 31. The latter have a portion of the steel core replaced by tracer and igniter composition. The igniter composition (essentially barium peroxide and magnesium) is pressed at about 70,000 lb./sq. in. with a step punch to present a large surface to the propellant powder gases for easier ignition. It burns through to the tracer composition (strontium peroxide and nitrate, magnesium, and other ingredients).

The length of trace for caliber .30 rounds is about 1200 yd., and for caliber .50 rounds, 1800 yd. A longer trace of 2500 yd. has been developed for caliber .50 rounds; the tracer composition is essentially strontium nitrate, potassium perchlorate, and magnesium, and is slower-burning. In the so-called night tracer cartridges, which neither blind the gunner nor reveal his position to the enemy, a dim igniter (essentially strontium peroxide, calcium resinate, and magnesium) burns for the first 100 yd. for the caliber .30 and the first 200 yd. for the caliber .50 bullet. A tracer caliber .45 bullet for submachine gun training traces for about 160 yd.

A so-called headlite tracer caliber .50 bullet satisfies the Air Force requirement for a bullet to simulate a ball of fire. The object is to make the enemy think that he is under fire from much larger-caliber weapons than small arms, and the psychological effect is pronounced. The standard M1 tracer bullet is modified by replacing the usual igniter and tracer

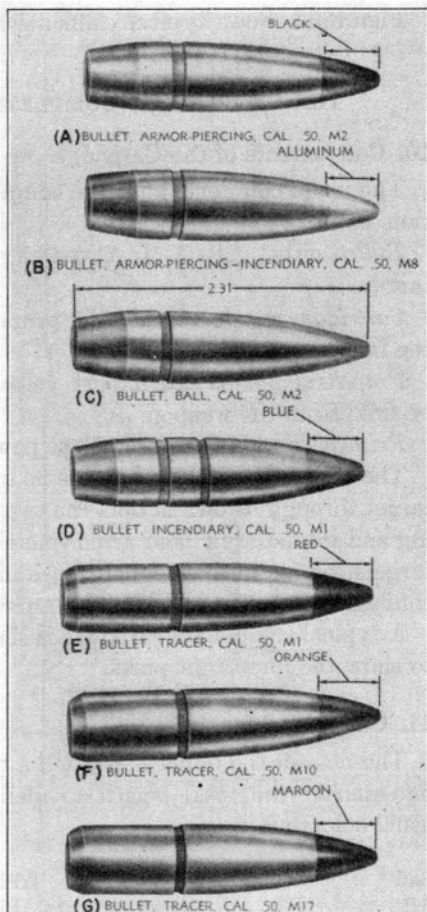

FIG. 32. Caliber .50 small-arms bullets.

composition by strontium peroxide igniter composition only; although the tracer distance is reduced from the usual 1800 yd. to about 600 yd. the visibility from the front end is about three times that of the usual tracer bullet. Thus the M21 headlite bullet really burns from the rear.

Figure 32 shows typical caliber .50 bullets in external view.

THE SMALL-ARMS COMPLETE ROUND OR CARTRIDGE

10. Components of the Cartridge.

The usual components of the complete round of small-arms ammunition, called a CARTRIDGE, are:

Bullet, either AP, T, I, API, ball, etc., to perform a mission at the target.

Cartridge case, to contain the primer and propellant powder; fixed to the bullet.

Propellant powder, to impart velocity to the bullet and cause it to be fired from the weapon.

Primer, to ignite the propellant powder when the firing pin strikes it.

The small-arms bullet contains no fuze, but the bullet functions at the target through its own action, the two principal types being armor-piercing and incendiary. The armor-piercing type is used for penetration of targets, or for antipersonnel use, and the incendiary type to institute conflagrations, primarily against aircraft.

A typical small-arms cartridge is shown in Fig. 29, completely labeled to show the important parts.

11. Cartridge Marking.

The nose of the bullet is painted a color from the tip extending about one-quarter the total length to identify the type of cartridge. The usual colors are:

Ball	No color	API	Aluminum
AP	Black	API-T	Red on nose, then aluminum
I	Blue		
T (1800 yd.)	Red		
T (dim igniter)	Orange	HPT	Black over entire length
T (2500 yd.)	Maroon		

There are certain other color markings, as on the caliber .45 shot, which is painted red over the entire portion outside the case.

Small-arms cartridges are marked on the primer end of the case with the initials of the manufacturer and the year of manufacture. The closing wad of shotgun shell is marked with the type of filler.

Some bullets have two cannellures, one for crimping the cartridge case and one for identification.

12. The Cartridge Case.

Figure 33 shows cartridge cases in cross section for cartridges of calibers .30, .45, and .50. Cases are of brass, consisting of 70% copper and 30% zinc, drawn from flat stock so that the finished case tapers in

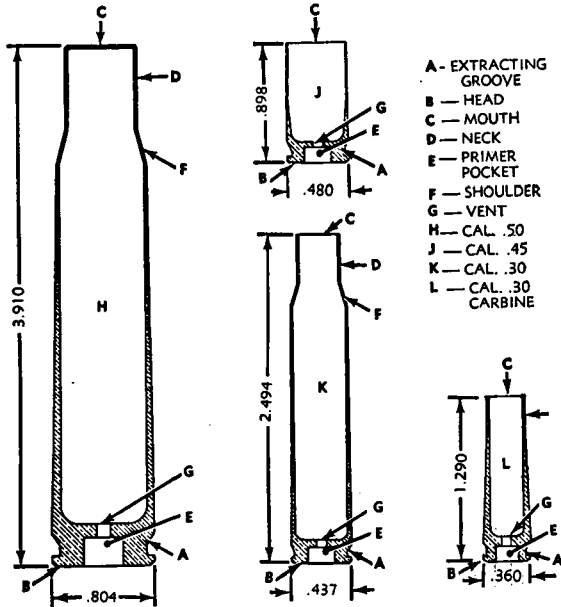

FIG. 33. Small-arms cartridge cases.

thickness from a fairly heavy section at the base to a comparatively thin section at the mouth. Around the head is the extracting groove, and in the head is a pocket into which the primer is pressed. The pocket is vented to the case chamber. The mouth of the case is crimped to the bullet cannellure, and this crimp determines the bullet pull which must be uniform for satisfactory functioning particularly of automatic weapons. The cases for the caliber .30 carbine and caliber .45 pistol have no shoulder but otherwise are of similar construction. The cases are all carefully inspected and tested, as described briefly in Art. 7.

The caliber .22 case is of the same general construction except that there is no separate primer, the primer mixture being under the rim of the case. This "rim fire" type of case is functioned by the firing pin squeezing the mixture in the rim flange, thus igniting it and the propellant powder.

13. Propellent Powder.

Small-arms propellent powder is usually single-base powder in the form of single perforated grains coated with DNT and glazed with graphite. They are loaded loosely in the case by machine. The grains are very small and are therefore subject to more rapid deterioration at high temperatures than artillery powder.

The charge for caliber .30 cartridges is about 50 grains; that for caliber .50 cartridges, about 240 grains. The corresponding velocities at 78 ft. are about 2700 and 2900 ft./sec., respectively. Of course the charge is adjusted to obtain the required velocity for each lot of powder.

The loading density is usually about 0.9 (see Chapter 7) compared to 0.3 to 0.7 for artillery rounds.

14. Primer.

The small-arms type of primer is discussed in Chapter 3, Art. 4, and is shown in Figs. 12 and 29. It is pressed into the primer pocket (*E*), shown in Fig. 33. When the firing pin hits the primer cup the mixture is pressed against the anvil, and the primer fires, its flash passing through the vent (*G*) to ignite the propellent powder.

15. Types of Cartridges.

Service Cartridges. The various types of service bullets have been discussed; they are ball, AP, T, I, API, and API-T. The complete rounds or cartridges made up of these bullets, together with the cases, primers, and powder, are also known as the cartridges of the corresponding type. The AP bullet becomes the AP cartridge; the API bullet, the API cartridge; etc. Standard caliber .30 cartridges of the AP, API, ball, I, and T types are shown in Fig. 34. Standard caliber .30 carbine cartridges and standard caliber .45 cartridges of the ball and T types are shown in Fig. 36. Various cartridges are shown in cross section in Fig. 37.

Other Cartridges. In addition to the usual service types, small-arms cartridges serve a variety of purposes, and these will be discussed briefly.

1. **Blank cartridges.** The BLANK CARTRIDGE consists of a primed case without bullet and filled with EC blank powder held in with a paper cup or wad for closing. The case has a cannellure at the neck to seat the wad, which is held in place by shellac and by rolling the mouth to form a crimp. Blank cartridges are used to simulate fire during maneuvers, signaling, saluting, and for instructional purposes with machine guns and automatic rifles.

Blank cartridges are made in calibers .22, .30, .45, and .50. Figure 35 shows a caliber .30 blank cartridge, and Fig. 36 a caliber .45 blank cartridge.

2. Rifle-grenade cartridges. For projecting rifle grenades from the caliber .30 rifle or carbine by means of grenade launchers a RIFLE GRENADE

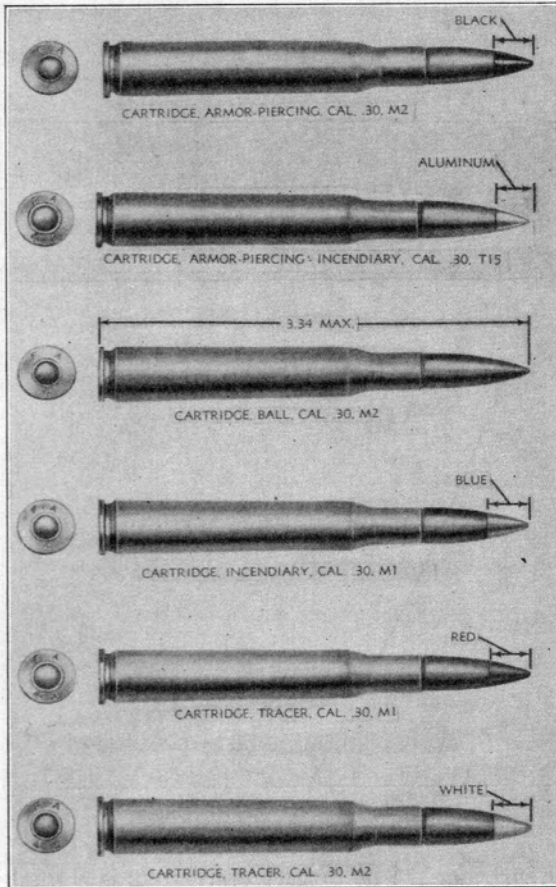

FIG. 34. Caliber .30 cartridges.

CARTRIDGE is used. Figure 36 shows the cartridges for the caliber .30 rifle and carbine, together with an auxiliary cartridge for obtaining additional velocity and range of the grenade. The M3 cartridge for the rifle has 5 grains of black powder in the base and 45 grains of progressive burning propellant powder on top of the black powder. The primed case has no bullet, and its mouth is closed by a wad held in place by a

cannelure just back of the mouth, which is closed by crimping in the shape of a five-leaf rosette for easy identification. The grenade without the auxiliary grenade cartridge has a velocity of 165 ft./sec. at 5.5 ft. from the muzzle; with the auxiliary cartridge, about 250 ft./sec.

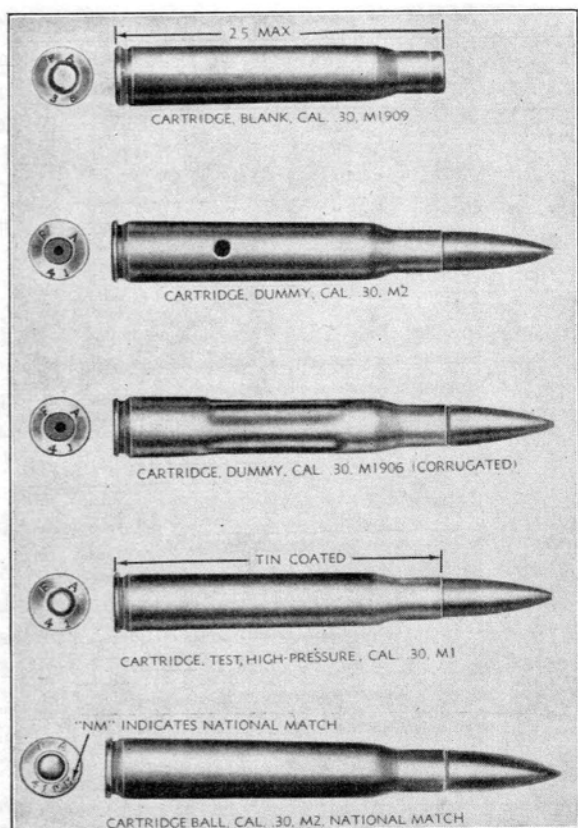

FIG. 35. Caliber .30 cartridges.

3. Dummy cartridge. The DUMMY CARTRIDGE is a totally inert cartridge, consisting of a ball-type bullet assembled into a case without primer or powder, the case being either corrugated or having a hole in it for identification as shown in Figs. 35 and 36. Dummy cartridges are used for training personnel in loading and unloading machine guns, ammunition belts, and for general instructional purposes, such as detecting faulty trigger squeeze. They are also used for testing extractions, ejections, and other mechanical features of weapons. Dummy

ammunition is available in calibers .30, .45, and .50. Second-class components may be utilized in making dummy ammunition.

4. **HIGH-PRESSURE TEST CARTRIDGES** are for testing weapons at a chamber pressure somewhat above the service pressure. They contain

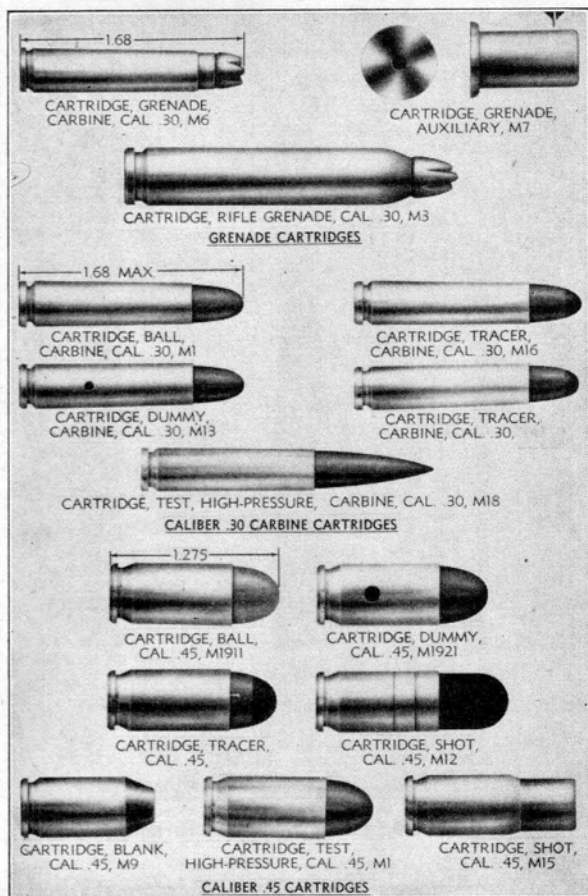

FIG. 36. Various small-arms cartridges.

heavy bullets and an excess powder charge, so that the pressures are about 20% higher than service pressures. These cartridges are usually tin-coated for identification. Typical specimens are shown in Figs. 35 and 36.

5. **Guard cartridges.** Sometimes for guard work cartridges having a reduced powder charge are employed, called **GUARD CARTRIDGES**.

6. SHOT CARTRIDGES are made in the caliber .45 size only; they contain shot of desired size in a bullet crimped to the case, as shown in

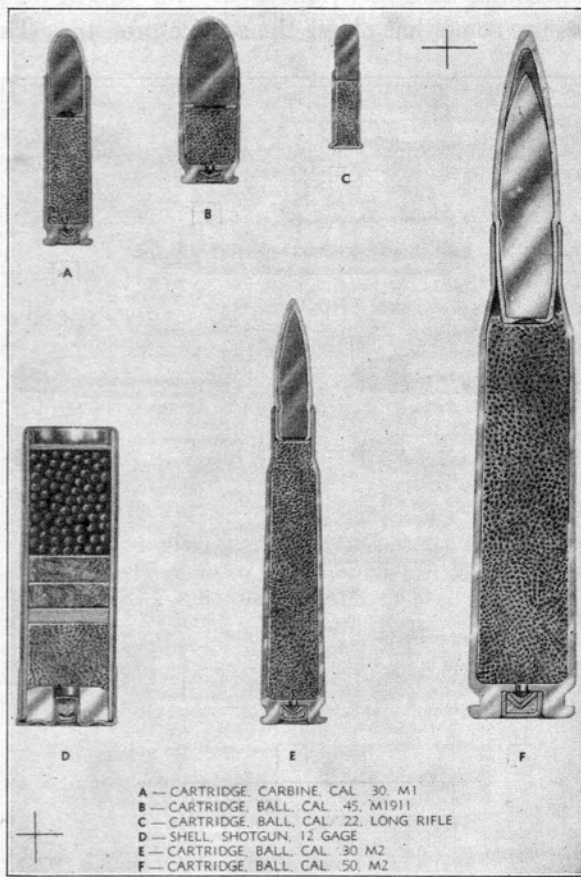

FIG. 37. Details of small-arms cartridges.

Fig. 36. They were developed for military personnel for hunting game in jungles.

16. Shotgun Shell.

SHOTGUN SHELL are purchased from commercial concerns for such purposes as guard duty, hunting, trap, and skeet shooting as well as combat service. A typical shell is shown in Fig. 37, in cross section; it consists of a laminated paper body, brass head with primer, propelling charge, distance and spacer wads, load of lead shot, and closing wad crimped to the body. Shotgun shells are loaded with No. 00 buck shot,

up to No. 8 chilled lead shot, and one type has a tracer. Commercial 12-gage shotgun shell are shown in Fig. 38.



FIG. 38. Shotgun shell.

Shotgun shell for combat have brass cases instead of paper cases, principally because they are more durable and waterproof. One of the most effective ways of investigating suspicious noises at night is to fire a few rounds of shotgun shell into the underbrush.

PART III
ARTILLERY AMMUNITION

CHAPTER 5

ARTILLERY PROJECTILES

1. General.

AN ARTILLERY PROJECTILE is a missile designed to be fired from a gun. Strictly speaking, a projectile usually consists of a shell and a fuze, though the terms SHELL and PROJECTILE are commonly used interchangeably. The design of a projectile is intimately connected with the design of the weapon in which it is intended to be fired, though this principle is often ignored and the projectile designer is required to design a projectile for a certain gun and meet certain military requirements at the same time, requirements which may be impossible of attainment in that particular gun.

Designing a projectile is unlike designing a bridge, where many well known formulas are applied and the detailed dimensions can be calculated for every part of the structure. The bridge designer can feel quite certain that a bridge constructed according to his design will be a good structure. But projectile designs are usually based on other, similar designs and certain empirical formulas. Stresses may then be calculated to determine whether the dimensions chosen provide sufficient factor of safety. The one real test of a satisfactory projectile is actual firing under the worst conditions expected. The old adage "The proof of the pudding is in the eating" was never more applicable than in ammunition design.

2. Types.

The principal types of projectiles are HIGH-EXPLOSIVE, in which the percentage of filler is as high as possible consistent with other requirements, such as good fragmentation; ARMOR-PIERCING, in which penetration of armor plate is the main consideration; CHEMICAL, of the same general type as high explosive, but filled with a chemical filler, including smoke mixtures; CANISTER, consisting of balls encased in a matrix; and ILLUMINATING, containing a candle which is ejected at a certain point in the trajectory and burns suspended on a parachute (usually considered a pyrotechnic device).

The ratio of the weight of filler to the total weight is approximately as follows:

HE shell	10 to 20%
Chemical shell	10 to 15%, depending upon chemical used, and about 15% for white phosphorus
AP shell	2 to 5%

This ratio may be somewhat higher for mortar shell. The percentage of the total weight that is explosive or other filler is called the CAPACITY of the shell. When we speak of a 20% capacity shell we mean that the weight of the explosive is 20% of the total weight as fired.

3. Requirements of a Satisfactory Projectile.

In general, the REQUIREMENTS of a modern projectile are ballistic efficiency, tactical efficiency, safety, and adaptibility to manufacture and loading by mass-production methods. A projectile has good ballistic efficiency when it has good stability and gives a maximum of range with a minimum dispersion at the target. It has good tactical efficiency when it does its job at the target. In respect to high-explosive projectiles this means proper fragmentation combined with destructive effect, and for armor-piercing projectiles it means maximum penetration for a given impact velocity. Good tactical efficiency for a chemical smoke shell is attained when a dense smoke cloud covering a large area at the target is obtained, whereas a canister is required to have a certain pattern at a specified distance from the gun.

Artillery projectiles must be safe, not only from the strength standpoint in that they are not overstressed but also from the loading standpoint so that no prematures will result from the bursting charge. Projectiles must also be safe to handle and ship. No projectile can really be considered satisfactory unless it can be made by modern mass-production methods. The designer must keep this point in mind, for many otherwise very satisfactory designs are rejected simply because they are not adaptable to mass-production manufacture.

Although these requirements speak for themselves, it is well to emphasize that the safety requirement may outweigh all the others. Again, if a projectile is so designed that it has satisfactory ballistics and performs its mission at the target, but is a bottleneck in production, the design is considered unsatisfactory.

4. Ballistics.

BALLISTICS is the study of the motion of projectiles, the study of motion inside the gun being called INTERIOR BALLISTICS and of that

outside the gun being called EXTERIOR BALLISTICS. TERMINAL BALLISTICS is the study of the action of the projectile at the target or at the terminus of its trajectory. Ballistics is an extremely interesting and complicated subject, and it will not be discussed in detail here. The Ballistics Research Laboratory at Aberdeen Proving Ground, Maryland, is continually adding to the vast store of information, both theoretical and practical, resulting from firings, on this subject.

To get a picture of what happens inside the gun, consider a projectile starting from rest and being accelerated to its maximum velocity at the muzzle by the pressure of the expanding propelling gases behind it. Typical pressure and velocity curves are shown in Fig. 39. For a 75-mm.

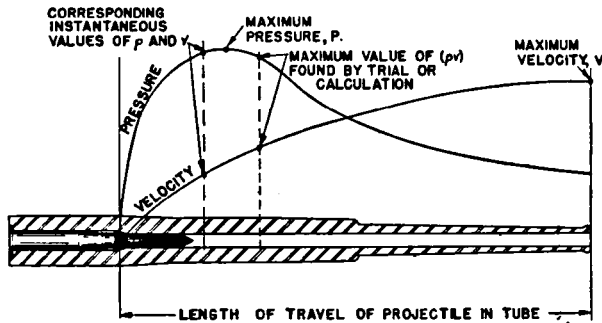

FIG. 39. Typical pressure and velocity curves for artillery projectiles.

projectile weighing about 15 lb., accelerating from 0 to 1500 ft./sec. velocity in a length of travel of about 6 ft., the time the projectile is actually in the gun is about $6/750 = 0.008$ sec., assuming an average velocity of 750 ft./sec. The actual time may be computed or determined from actual firings; for the 75-mm. projectile it is 0.0069 sec. The speed of rotation, assuming a twist of 1 in 25 calibers, and a bore of 3 in., would be, from equation 1, Art. 5,

$$\frac{1500 \times 12 \times 60}{3 \times 25} = 14,400 \text{ r.p.m.}$$

The time of flight, assuming a range of 39,000 ft. and an average velocity outside the gun of 1000 ft./sec., would be 39 sec. In other words, all the work of accelerating the projectile is done in a fraction of a second, as against a comparatively long time of flight, the ratio being about 5000 to 1.

Strictly speaking, the maximum velocity may not be *exactly* at the muzzle, but just outside the muzzle, as the projectile may be *slightly* accelerated after emergence from the bore by the expanding propellant

gases just after friction between the projectile and the bore has ceased. After the projectile passes through the cloud of gases, it is subject to retardation due to air resistance. In this treatise we shall consider the velocity a maximum at the muzzle.

5. Design Formulas.

Most of the formulas applied in shell and fuze design in computing size, shape, and stresses are developed from either empirical or a combination of empirical and theoretical considerations. In this treatise, the object is merely to define the nomenclature and list the more important formulas, but not to derive them or discuss them in detail. The following symbols will be used in discussing artillery ammunition:

L = effective width of rotating band, in inches.

A = area of bore of cannon, in square inches.

(pv) max. = maximum value of product of velocity, in feet per second, and pressure, in pounds per square inch, found by trial from pressure-velocity curves.

n = calibers per turn of rifling.

N = number of grooves.

a = area of cross section considered, in square inches.

h = height of column of charge from considered section to foremost point, in inches.

d_i = diameter of band seat, in inches.

d_1 = inside diameter of projectile at section considered, in inches.

d_2 = outside diameter of projectile at section considered, in inches.

D_g = depth of grooves, in inches.

v = velocity, in feet per second, at any position in gun tube.

W' = weight of all metal forward of section considered, in pounds.

P = maximum pressure, in pounds per square inch.

W = total projectile weight, loaded and fuze, in pounds.

Δ_1 = density of filler, in pounds per cubic inch.

Δ_2 = density of shell material, in pounds per cubic inch.

k = a constant.

Σ = total setback, in pounds per pound.

R_0 = interior radius of projectile, in inches.

R_1 = exterior radius of projectile, in inches.

s_1 = tangential stress in band, in pounds per square inch.

W_c = weight of propelling charge, in pounds.

V_c = capacity of cartridge case, in cubic inches.

s_2 = actual longitudinal stress at point of maximum pressure, in pounds per square inch.

- s_3 = hydraulic pressure on walls, in pounds per square inch.
 s_4 = tangential stress due to hydraulic pressure s_3 .
 s_5 = pressure due to rotation (in walls), in pounds per square inch.
 s_6 = resultant stress in shell walls due to rotation of charge, in pounds per square inch.
 s_7 = tangential stress in walls due to rotation of shell, in pounds per square inch.
 s_8 = resultant longitudinal stress in shell walls, in pounds per square inch.
 s_9 = resultant tangential stress in shell walls, in pounds per square inch.
 D = caliber, in inches.
 V = muzzle velocity in feet per second.
 p = pressure, in pounds per square inch, at any position in gun tube.
 S_0 = stability factor at the muzzle.
 A_m = axial moment of inertia, in pounds per square inch.
 B_m = transverse moment of inertia, in pounds per square inch.
 C_u = air moment coefficient.
 C_v = normal force coefficient.
 h_1 = distance of center of pressure from base, in calibers.
 h_2 = distance of center of gravity from base, in calibers.
 ω = weight of any fuze or projectile part, rotating about an axis, in grains.
 C = creep force on any fuze part of ω grains.
 p_1 = unit pressure on fuze nose, in pounds per square inch.
 R = distance from center of gravity to center of rotation for any fuze or shell part of ω grains, in inches.
 RPM = speed of rotation of any fuze or shell part of ω grains, in revolutions per minute.
 g = acceleration of gravity, in feet per second per second.
 α = maximum acceleration of projectile in gun (setback), in feet per second per second.
 H = height of drop in drop tower, in feet.
 f = distance in which component is decelerated in drop tower, in inches.
 t = time during which component is decelerated in drop tower, in seconds.
 C_R = creep resistance coefficient.
 CF = centrifugal force on any part of ω grains.

General Proportions. Some problems of shell design lend themselves to rigid mathematical analysis, and others are best solved by means of empirical formulas. In any event, a new shell is usually patterned after existing shell, especially as regards its general proportions, and the design is usually influenced by practical considerations as well. Table 9 gives some general proportions and information on artillery shell, where D is the diameter or caliber in inches.

TABLE 9
GENERAL PROPORTIONS OF ARTILLERY SHELL

Weight, in pounds	$\frac{D^3}{2}$
Length, in inches	4 to $6D$
Ogive length, in inches	2.5 to $3D$
Ogive shape	Ogival or conical
Radius of ogival ogive, inches	7 to $9D$
Bourellet width, inches	$D/6$
Boattail length, inches	$D/2$
Boattail angle	5 to 9°
Length of straight portion between boattail and band, inches	$D/4$
Rotating band width, inches	$D/3$
Stability factor	Less than 1 (projectile will tumble) 1 to 1.3 (may be satisfactory) Over 1.5 (desirable) Over 2.5 (may not nose over)
Bourellet clearance, inches	$0.002 \text{ in.} + 0.001D$
Rotating band diameter, inches	Diameter across grooves + 0.02 in.

The air resistance against the motion of a projectile consists of three parts: the resistance of the head, the skin friction due to both rotation and translation, and the drag on the base. It is the general overall shape of the projectile which must be considered in designing for minimum air resistance. The contribution to resistance of the head and base may be additive since the air passes over both, although it is possible that a change in head design may so change the air flow that the base drag is decreased without a change in the design. However, we shall consider that the two resistances are additive and that each is to be kept to a minimum.

The shape of the OGIVE is important. It is a very practical rather than a theoretical consideration because the air resistance as the projectile moves along its trajectory causes a considerable loss in range, and anything that decreases the air resistance and increases the range is ex-

tremely desirable. A 75-mm. projectile of normal range, 15,000 yd., would have a range of over 50,000 yd. in a vacuum. The effect of streamlining the front of the projectile is greater for higher velocities; in fact, streamlining the ogive and fuze of projectiles fired at velocities below, say, 1100 ft./sec. may result in no practical advantage and might even be detrimental. But for long-range, high-velocity projectiles the increase in range is tremendous. For example, the 8-in. high-explosive projectile, fuzed with the standard contour fuze, has a range of 21,000 yd. (MK I HE shell, 210 lb., as fired, M51 type fuze, radius of ogive 7D), compared to 35,600 yd. when streamlined (M103 shell, 240 lb. as fired, long, false ogive of equivalent radius 57D).

The boattail design is also a function of the projectile velocity, the boattail being beneficial below about 2900 ft./sec. This fact partly explains why many high-explosive projectiles have boattails and many armor-piercing projectiles do not, as the latter are normally fired at higher velocities. Article 9 of Chapter 4 discusses boattail effectiveness.

In general, therefore, for velocities above 1100 ft./sec., the longer the ogive the less the air resistance and the smaller the beneficial effect of the boattail. Below 1100 ft./sec. the advantages of the long ogive diminish and a relatively blunt 2-caliber ogive is sometimes used. Of course, a boattail greatly reduces air resistance below 1100 ft./sec.

Speed of Rotation. The projectile is rotating at the maximum rate at the muzzle, where the linear velocity is maximum and the projectile rotating band is still engaging the rifling. The speed of rotation at the muzzle is expressed by the equation

$$RPM = \frac{720V}{nD} \quad (1)$$

where $720V$ is the linear velocity in inches per minute at the muzzle, and nD is the number of inches the projectile must travel linearly in order to complete 1 revolution. Since most guns have a twist of 1 in 25 ($n = 25$), the equation shows that the rotational speed varies inversely as the caliber, for a given velocity. Thus, a 6-in. gun having the same twist and velocity as a 3-in. gun causes the projectile to rotate only half as fast. A 37-mm. high-explosive projectile fired at 1000 ft./sec. from a gun with a 1 in 25 twist rotates at a speed of

$$\frac{720 \times 1000}{25 \times 1.45} = 20,000 \text{ r.p.m.}$$

whereas a 37-mm. armor-piercing projectile fired at 3000 ft./sec. with the same twist rotates at 3 times that rate or 60,000 r.p.m.

The speed of rotation at any point in the bore can be computed by substituting the velocity at that point in equation 1, as determined from the velocity curve of that projectile. However, maximum speed of rotation is usually computed. During flight, rotation has been found to drop off from 10 to 30%, depending on range, type of weapon, etc., and may even drop off more under certain conditions.

Rotating Band. The rotating band affects flight characteristics, and a slight change in its position or its size may change the external ballistics, especially if the band is near the beginning of the boattail. Present designs of band are of the "non-fringing" type, with circumferential grooves in the band or to the rear of the band so as to provide a cavity for the displaced metal resulting from engraving by the rifling when



FIG. 40. Types of rotating bands for artillery projectiles.

fired. Without such grooves, the fringe, which may be formed irregularly like segments of a ring because of centrifugal force or gas pressure, may affect exterior ballistics. Typical band cross sections are shown in Fig. 40.

1. Width of rotating band. Assuming a uniform rifling, that failure of the band is due to melting instead of shearing, and that melting depends on the product of the pressure on the driving side of the lands and linear velocity, we may express the effective width of the rotating band by the formula

$$L = \frac{0.6\pi A(pv) \max.}{2 \times 10^7 nND_g} \quad (2)$$

where the effective width is the width of that portion actually in contact with rifling.

2. Stress in rotating band from centrifugal force. This stress is expressed by the formula

$$s_1 = 1.19 \left(\frac{V}{n}\right)^2 \left[\frac{D - d_i}{D - d_i - 2D_g} \right] \quad (3)$$

Stresses in Projectile Walls.

1. Stress in shell walls due to setback. This stress is a result of the setback of metal parts ahead of the section considered; it is expressed by

$$s_2 = \frac{W'PA}{Wa} \quad (4)$$

2. Stress in shell walls due to setback of explosive charge. The shell walls are also stressed by the setback of the explosive charge. On the assumption that the charge exerts a hydraulic pressure in all directions, the total setback is expressed by

$$\Sigma = \frac{PA}{W} \quad (5)$$

and the hydraulic pressure on the walls is

$$s_3 = \Delta_1 h \Sigma \quad (6)$$

The resultant stress, by Birnie's formula, is

$$s_4 = \frac{4R_1^2 + 2R_0^2}{3(R_1^2 - R_0^2)} s_3 \quad (7)$$

3. Stress in shell walls due to rotation of charge. The pressure due to the rotation of the charge is

$$s_5 = 1.85 \Delta_1 \left(\frac{V}{n}\right)^2 \left(\frac{d_1}{D}\right)^2 \quad (8)$$

which is also converted to resultant stress by

$$s_6 = \frac{4R_1^2 + 2R_0^2}{3(R_1^2 - R_0^2)} s_5 \quad (9)$$

4. Stress in shell walls due to rotation of shell body. This stress is expressed by

$$s_7 = k \Delta_2 \left(\frac{V}{n}\right)^2 \left(\frac{d_2}{D}\right)^2 \quad (10)$$

where the constant k is usually 3.2 to 3.7, depending on the wall thickness, and being 3.7 for very thin walls.

5. Resultant stress in shell walls. Using Poisson's ratio as $\frac{1}{3}$, these stresses in the shell wall may be combined to obtain the resultant longitudinal and tangential stresses, as

$$s_8 = s_2 + \frac{1}{3}(s_4 + s_6 + s_7) \quad (11)$$

$$s_9 = s_4 + s_6 + s_7 + \frac{s_2}{2} \quad (12)$$

Of course, the resultant stresses must not exceed the elastic limit of the steel and should be somewhat less, say at least 25% less.

Stability Factor. The computation of the stability factor is somewhat more involved than the computation of stresses, the fundamental formula being

$$S_0 = \frac{\pi^2 A_m^2}{n^2 D^5 B_m C_u} \quad (13)$$

where S_0 = stability factor at the muzzle.

A_m = axial moment of inertia, in pounds per square inch.

B_m = transverse moment of inertia, in pounds per square inch.

C_u = air moment coefficient.

The values of A_m and B_m can be calculated by breaking the shell up into arbitrary sections and calculating the moments by sections. The value of C_u is usually determined experimentally by firing, or from available data already collected at the Ordnance Ballistics Research Laboratory. It is expressed by the formula

$$C_u = \frac{C_v(h_1 - h_2)}{12} \quad (14)$$

where h_1 = distance of center of pressure from base, in calibers.

h_2 = distance of center of gravity from base, in calibers.

C_v = normal force coefficient, determined from experimental firings.

A stability factor of less than 1 as computed from equation 13 means that the shell is very unstable and will probably tumble in flight, whereas

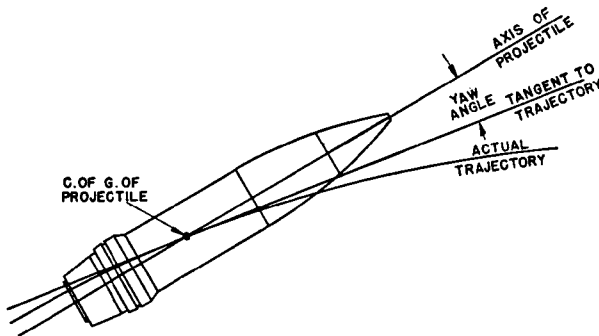

FIG. 41. Angle of yaw with reference to projectile path.

a projectile with a stability factor between 1.2 and 1.5 and having a small angle of yaw may be considered satisfactory. A stability factor above 1.5 means that the stability is good, but there is a disadvantage in having a large stability factor, say over 2.5, because the projectile may not nose over. Of course this would not affect the performance of armor-piercing projectiles but it would seriously affect the functioning of high-explosive shell, especially where fuze impact on the nose is required.

The YAW is the angle which the axis of the projectile makes with the tangent to the trajectory at any given point at the center of gravity of the projectile, as shown in Fig. 41. Yaw at the muzzle is caused by all

the factors which tend to make the axis of the projectile incline to the axis of the gun as the projectile leaves the muzzle. Without going into the theory of ballistics, we will merely state that these factors include the bourrelet clearance, clearance at base of projectile and gun bore, failure of the rotating band to center and hold the projectile base on gun axis, dynamical unbalance of the projectile, centrifugal force due to center of gravity of projectile not coinciding with projectile axis, combined displacement of center of gravity of projectile due to bourrelet clearances, and insufficient rotation. Variation in the yaw between different projectiles is one of the important factors contributing towards dispersion, which it is always desirable to keep at a minimum.

The stability factor S_0 is thus seen to be the ratio of the moment of air force tending to increase yaw to the moment of kinetic reactions tending to decrease yaw. The subject of stability is involved, and it has been made the subject of investigation over a period of years at the Ordnance Ballistics Research Laboratory.

6. Projectile Design Tests.

Certain tests that may be conducted during the course of the design of a projectile, preliminary to actual firing, in order to assure the designer that his method of approach is substantially correct, are summarized below.

Setback Test (Drop Test). This test is described in detail in Chapter 6, Art. 11, as it is used more often in fuze design than in projectile design. Yet it may be desirable to perform a SIMULATED SETBACK or DROP TEST to check projectile loading or the strength of a questionable wall section. Projectiles may be sectionalized after dropping to check the effect of setback.

Band Functioning. Recovery firings may be conducted to check the design of rotating band to determine whether the band strips or the rifling is being wiped off because of excessive band pressure.

Ballistic Tests. Ballistic firings are conducted to obtain information about stability, range, dispersion, gun pressure, velocity, strength, and explosive safety.

Loading Tests. In order to determine whether the projectile can be loaded with the method and type of explosive specified for the new shell, loading tests are conducted.

Functioning Tests. Depending upon the type of projectile, an appropriate test of functioning is conducted. A FRAGMENTATION TEST may be conducted on a high-explosive shell, a PENETRATION TEST on an armor-piercing shell, a SMOKE-FORMATION TEST on a smoke shell, and a PATTERN TEST on a canister.

Some functioning tests are conducted statically behind a barricade to check explosive train functioning, burster and booster functioning, and any other effects not dependent on ballistics. For this purpose, explosive trains are initiated electrically.

7. Zone Weights and Marking.

The weight of a loaded projectile cannot be held absolutely constant because certain tolerances must be allowed for manufacture and loading, and there are certain other variables, such as variations in the density of the metals and the explosives. Variation in weight is not much of a factor with smaller-caliber projectiles, say under 75-mm., but for a 155-mm. projectile the loaded weight will vary as much as 10 lb. Obviously, such a difference in weights for a group of projectiles of the same caliber would cause a large difference in range if provision were not made for it. It is customary, therefore, to divide the total allowable weight variation arbitrarily into WEIGHT ZONES, and, as the loaded projectiles come off the loading line, to weigh them, and mark them with a symbol indicating into which weight zone they fall.

Firing tables, or range tables, are computed on this basis, a weight zone near the middle of the range being considered normal, and a gun adjustment being required for the weight zones on either side of the normal one. The following table gives the weight zones for the 75-mm. M48 HE shell:

ZONE	OVER	UP TO AND INCLUDING	MARKING
L (low)	11.80 lb.	12.12 lb.	L
1	12.08	12.42	+
2	12.38	12.72	++ (No range table correction)
3	12.68	13.00	+++

It will be noticed that the zones slightly overlap; this allows the collection of more shell in one weight zone. For example, if 75-mm. shell are running around 12.00 lb. and the first zone limit were 12.08 lb., then all shell over 12.08 lb. would have to be placed in another zone and lot; there might be only a few of them and they would have to be collected for a long time until enough were accumulated to make a lot. But since the limit is 12.12 lb., which is over the minimum for the next zone, all shell up to 12.12 lb. can be placed in the same zone and lot.

As indicated in the table, the weight zones of 75-mm. projectiles are indicated by plus marks or by the letter "L"; for 76-mm. and over, the marking consists of painted squares. A prick punch mark is made in the center of each square on shell ranging from 155 mm. to 10 in.

For very large projectiles, 10-in. and over, the weight is stamped on the shell to the nearest pound.

This system of weight zones applies to high explosive and chemical projectiles of 75 mm. and above. All other projectiles, except armor-piercing of 6 in. and above, are not zone marked, such 6-in. and above armor-piercing projectiles being marked to the nearest pound.

TYPES OF ARTILLERY PROJECTILES

8. High-Explosive Shell.

Description. The description and functions of the various parts of a typical HIGH-EXPLOSIVE SHELL can be best understood by reference to Figs. 42 and 44D. The BODY is generally cylindrical in shape, the tapered portion near the nose being called the OGIVE. The fuze and ogive meet to form a smooth contour. The BOURRELET is a smoothly machined section back of the ogive, the diameter of which is a few thousandths of an inch less than the diameter across the lands of the gun tube. The bourrelet rides on the lands and supports the front portion of the projectile as it travels through the bore.

The ROTATING BAND, usually of gilding metal, is located to the rear of the body. It performs several functions. First, it imparts rotation to the projectile because its diameter is somewhat larger than the bore diameter and therefore becomes ENGRAVED as the projectile travels through the bore. Second, it acts as a gas seal, preventing the hot propelling gases from passing this point, so that the expansion is utilized to do the useful work of imparting projectile motion. Third, it acts as a rear bearing for the projectile, complementing the bourrelet.

The tapered section to the rear of the rotating band is called the BOAT-TAIL, the purpose of which is to increase stability within certain velocity limitations. The BASE COVER of sheet steel is welded or brazed to the shell base for the purpose of preventing any hot gases from contacting the bursting charge in the event that any porosity exists in the shell base.

Some high-explosive shell of older design are base fuze, particularly 6-in. and over. They are common-steel projectiles with heavy noses and walls, supposed to give a little penetration, say $\frac{1}{10}$ to $\frac{1}{5}$ caliber, but they have not been produced for some years. One high-explosive shell which is base fuze is still in production and use, the 37-mm. 1.6 lb. shell loaded with flake TNT, and used at short ranges against machine-gun nests, barbed wire, etc., and at graze impact against personnel.

Fragmentation. High-explosive shell are employed to obtain DEMOLITION effect against material, or FRAGMENTATION effect against personnel.

For antipersonal purposes, it is desirable to control the size of the fragments within certain limits, as fragments that are too small are ineffective, and fragments that are too large have low velocity and do not carry very far. Fragmentation is accomplished by detonating the shell in a

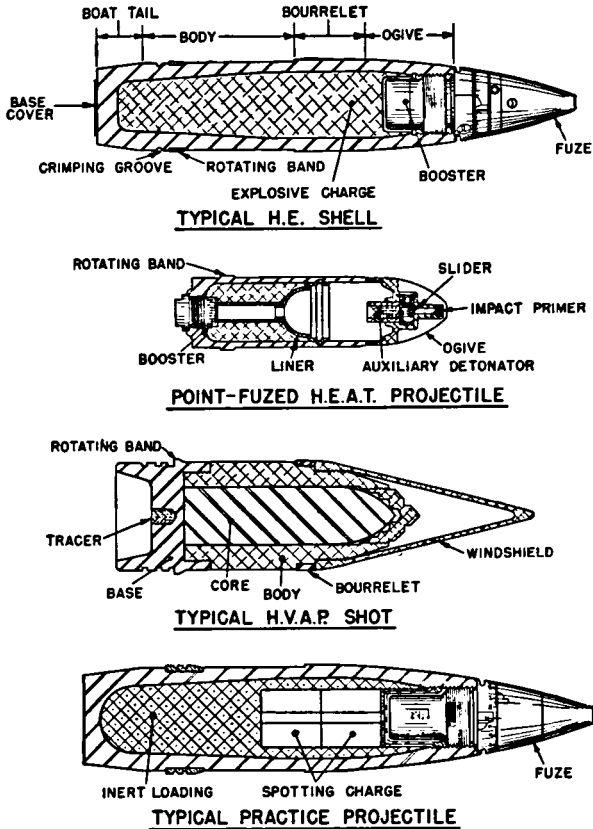

FIG. 42. Various artillery projectiles.

large pit of sand and collecting the fragments by screening the sand through a No. 4 screen, after which the fragments are weighed and classified into the weight groups 0-75, 75-150, 150-750, 750-2500, and over 2500 grains. The percentage recovery is the ratio of the weight of the collected fragments to the original unloaded shell weight.

Good fragmentation is considered to have been obtained when most of the fragments fall in the middle weight groups, and the total number of recovered fragments is near the average usually obtained for a shell of that size, type, and material. For example, a typical good fragmenta-

tion test for 75-mm. M48 forged-steel shell resulted in 95% recovery, no fragments over 750 grains, 57% between 150 and 750 grains, 23%

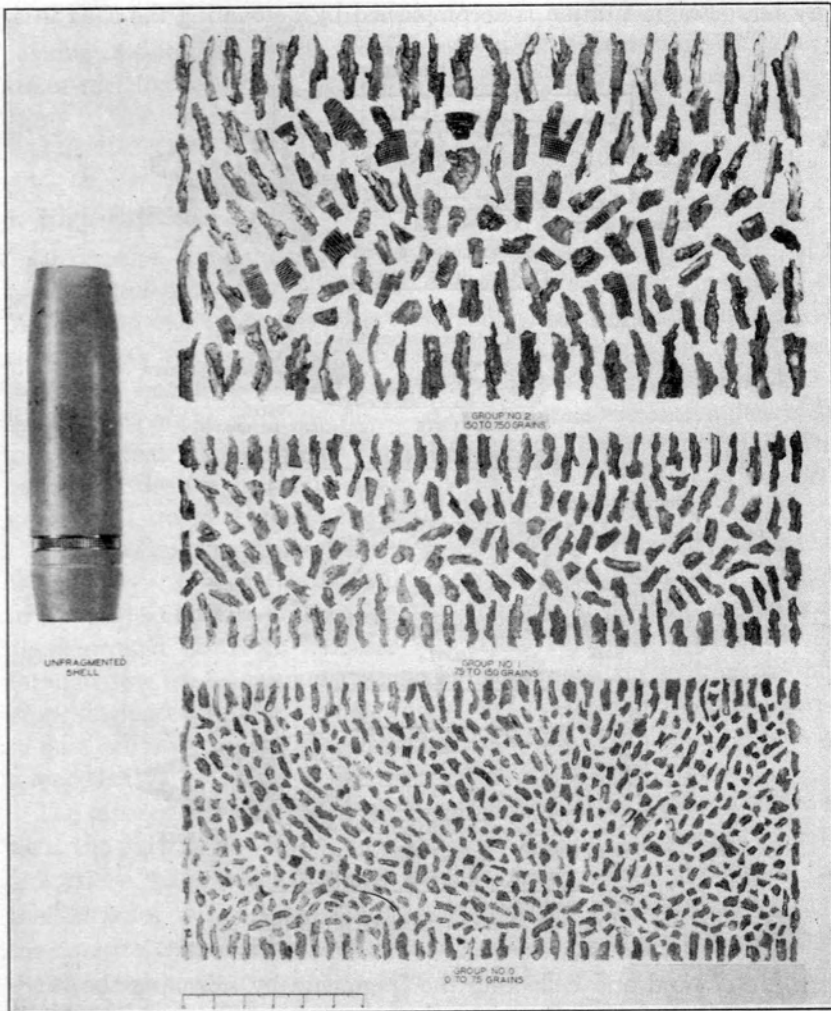

FIG. 43. Typical artillery-shell fragments.

between 75 and 150 grains, and 15% under 75 grains, the total number of fragments being about 1000.

These steel fragments are popularly but erroneously called shrapnel. Real SHRAPNEL used in World War I consists of a shell filled with steel or lead balls with a base expelling charge and functioned by a time fuze

flashing through a central tube. Actual shell fragments are more effective, and a high-explosive shell can be used for either fragmentation or demolition effect. Figure 43 shows typical fragments.

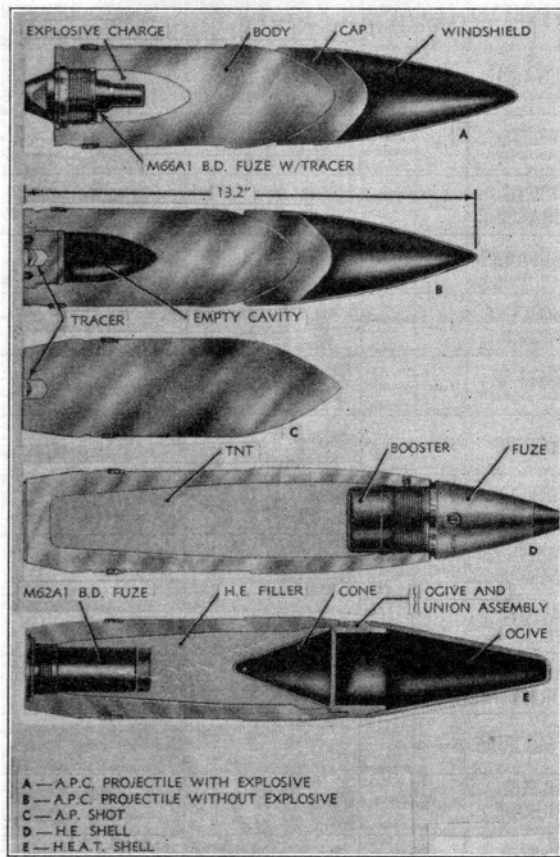

FIG. 44. Various artillery projectiles.

9. Chemical Shell.

Chemical Agents.

1. CHEMICAL AGENTS in the general sense of the word are agents used by the Chemical Warfare Service; they include chemicals, either solid, liquid, or gaseous, used in chemical shell, bombs, grenades, rockets, etc.; smokes, used in smoke shell, bombs, grenades, rockets, etc.; and incendiaries, used primarily in bombs, but also in shell and other components. Most people think of chemical warfare as inhuman and as being conducted with poison gas, but the latter phrase is a

ARTILLERY PROJECTILES

TABLE 10

DATA ON CHEMICAL AGENTS













SYMBOL	NAME	CLASS	BANDS COLOR	LOADING	ODOR	TACTICAL CLASS	PHYSIOLOG- ICAL EFFECT
H	MUSTARD <small>DITHIOLOETHANE SULFIDE</small>	Gas	2 Green		Garlic Horseradish Mustard		Burns skin or membrane
L	LEWISITE <small>(ETHYLPHOSPHORIC DIORARSINE)</small>	Gas	2 Green		Geraniums		Irritates nasal pas- sages. Later skin burns, poison.
ED	ETHYLDI- CHLORARSINE	Gas	2 Green		Biting Stinging		Causes blisters, sores
PS	CHLORPICRIN <small>NITRITRICHLOROFORM</small>	Gas	2 Green		Flypaper Anise		Causes severe coughing, crying, lung edema
DP	DIPHOSGENE <small>TETRACHLOROETHYLENE DICHLOROCARBONATE</small>	Gas	2 Green		Musty Hay Green Corn Ensilage		Causes coughing, breathing hurts, eyes water, toxic
CG	PHOSGENE <small>CARBONYL CHLORIDE</small>	Gas	1 Green		Musty Hay Green Corn Ensilage		Irritates lungs
CL	CHLORINE	Gas	1 Green		Highly Pungent		Intense immediate choking
CN (CNS)	CHLORACETO- PHENONE	Gas (Solution)	1 Red (2 Red)		Apple blossoms		Makes eyes smart, shut tightly, tears flow. Temporary.
BBC	BROMBENZYL- CYANIDE	Gas	2 Red		Sour fruit		Eyes smart, shut, tears flow. Effect lasts some time.
DM	ADAMSITE <small>DIPHENYLAMINE DITHIOCARBONATE</small>	Gas	1 Red		Coal Smoke		Causes sneezing, sick depressed feeling
PD	DIPHENYL- CHLORARSINE	Gas	1 Red		Shoe Polish		Causes sneezing, sick depressed feeling
HC	HC MIXTURE	Smoke	1 Yellow		Sharp-acrid		Harmless
FS	SULFUR TRIOXIDE <small>IN CHLOROSULFONIC ACID</small>	Smoke	1 Yellow		Burning matches		Liquid burns skin if allowed to remain—
FM	TITANIUM TETRACHLORIDE	Smoke	1 Yellow		Acrid		Harmless
WP	WHITE PHOSPHORUS	Smoke	1 Yellow		Burning matches		Burning pieces adhere to skin, clothing
†TH	THERMIT <small>(THERMITE) IRON OXIDE AND ALUMINUM POWDER</small>	Incen- dinary	1 Purple		Odorless		5000 degree F heat ignites materials

CNS, A SOLUTION OF CN IN CHLOROFORM AND CHLORPICRIN, FREQUENTLY USED FOR SHELL FILLING

† THE FILLING OF A MAGNESIUM BOMB WHICH SERVES TO IGNITE THE METAL MAGNESIUM CASING

TABLE 10—Continued

DATA ON CHEMICAL AGENTS

PROTECTION	FIRST AID	COLOR & STATE		PERSISTENCE	TACTICAL USES
		LOADED	RELEASED		
	Remove clothing. Wash affected parts of body with soapy water. Irrigate eyes with 2% sodium bicarbonate solution	HEAVY DARK OILY LIQUID	Liquid slowly evaporates	Open - 1 day Woods - 1 week to all winter	To neutralize areas Counter-battery Attack on Personnel
	Apply 2 to 5% solution hydrogen peroxide to skin; wash with soap and water. Irrigate eyes with water or 2% sodium bicarbonate solution	HEAVY DARK OILY LIQUID	Liquid slowly evaporates	Open - 1 day Woods - 1 week	Similar to Mustard
	Apply 2 to 5% solution hydrogen peroxide to skin; wash with soap and water. Irrigate eyes with water or 2% sodium bicarbonate solution	CLEAR OILY LIQUID	Evaporates at medium rate.	1 hour	Counter-battery Preparation fire Harassing fire
	Wash eyes, keep quiet and warm. Do not rub eyes	YELLOW OILY LIQUID	Evaporates like water.	Open 6 hours Woods - 12 hours	Harassing and casualty fire
	Keep quiet and warm Give coffee as a stimulant	COLORLESS LIQUID	Evaporates like water.	30 minutes	Harassing and casualty fire
	Keep quiet and warm Give coffee as a stimulant	COLORLESS LIQUID	Colorless gas	10 to 30 minutes	Surprise attacks, projectiles Gas cloud release For quick physical effect
	Keep quiet and warm Coffee as stimulant	YELLOW LIQUID	Yellow-green gas	10 minutes	Surprise attacks (cloud)
	Wash eyes with water or boric acid. Do not rub or bandage. Wash skin with 4% Na ₂ SO ₃ in 50% Alcohol Solution	WHITE CRYSTALLINE POWDER	Cloud of small, solid particles	10 minutes	Training Mob control CNS used in counter-battery to force mask wear
	Wash eyes with boric acid Do not bandage	DARK BROWN OILY LIQUID	Slowly evaporates	Several days (weeks in winter)	To neutralize areas Counter-battery
	Remove to pure air and keep quiet. Breathe small amounts of chlorine	YELLOW-GREEN GRANULAR SOLID	Yellow smoke	10 minutes	Gas Cloud Attacks Mob control
	Remove to pure air, keep quiet Sniff chlorine from bleaching powder bottle	WHITE CRYSTALLINE SOLID	Vapor or fine smoke	Summer 10 minutes	Harassing fire
NONE NEEDED	Produces no effect requiring treatment	GREY SOLID	White to grey smoke	While burning	To screen small operations in own lines and for training purposes
	Wash with Soda solution	CLEAR TO BROWN LIQUID	Dense white smoke	5 - 10 minutes	Airplane spray for screen on broad front
NONE NEEDED	Produces no effect requiring treatment	YELLOWISH TO BROWN LIQUID	White smoke	10 minutes	Screening operations
NONE AVAILABLE	Wash with Copper Sulphate solution or immerse in water	PALE YELLOW SOLID	Burns to white smoke in air	10 minutes	To screen advancing troops Cause incendiary effects, losses Harass enemy observers
COVER WITH EARTH, SAND	Treat for burn	METALLIC POWDER	White-hot metal	5 minutes	Destruction of Material

misnomer, and more casualties are obtained by means of conventional ammunition than by chemical ammunition, even when it is employed. Poison gas has not been used in World War II. Chemical ammunition is either of the smoke or incendiary type.

We may define **CHEMICAL AGENTS** as any substance used in warfare, which, by its ordinary and direct chemical action, produces either a physiological effect, smoke, or incendiary action. A satisfactory chemical agent must be effective in small concentrations, easily made in large quantities, inexpensive, easy to transport and load, heavier than air, and non-reactive with other ammunition components with which it is in contact.

Table 10 presents a summary of the chemical agents, including tactical uses and types of ammunition in which they are loaded.

2. Classification and identification. Chemical ammunition is classified according to the type of filler, and one or more colored bands are stenciled on the ammunition to identify it accordingly: casualty agents have green marking; irritating or harassing agents, red; screening smokes, yellow; and incendiary agents, purple. The persistency of these agents determines the number of bands of these various colors, persistent agents being marked with two bands and non-persistent agents with one band. A persistent agent is defined as one that is effective 10 minutes or longer.

Chemical agents may also be classified according to their physiological effects as lung irritants, vesicants, lacrimators, and sternutators. These are sometimes called choking gas materials, blister gas materials, tear gas materials, and vomiting gas materials, respectively. To them must be added systemic poisons like AC and CK (hydrocyanic acid and cyanogen chloride, respectively).

3. Lung irritants. An agent that when breathed causes irritation and inflammation of the bronchial tubes and lungs is called a lung irritant or a choking gas material. Chlorpicrin (PS), diphosgene (DP), phosgene (CG), and chlorine (Cl) are the usual lung irritants. All are chlorine compounds and have the general effects of chlorine when breathed, but DP and CG have the most pronounced effect, about 10 times that of Cl.

4. Vesicants. An agent that is readily absorbed through both the exterior and interior parts of the body, causing inflammation, blisters, and general tissue destruction, is called a vesicant or blister gas material. Mustard (H), lewisite, and ethyldichlorarsine (ED) are vesicants; they are also chlorine compounds, and lewisite and ED contain arsenic as well.

5. Lacrimators. An agent that causes a copious flow of tears, together with intense, though temporary, eye pain, is called a lacrimator, or tear gas material. Chloracetophenone (CN) and brombenzylcyanide (BBC)

are the usual tear gases, the former being a chlorine and the latter a bromine compound.

6. Sternutators, or irritant smokes, sometimes called vomiting gas materials, are agents that cause sneezing, coughing, lacrimation, headache, nausea, and temporary physical disability. Adamsite (DM) and diphenylchlorarsine (PD) are in this class, both being compounds of chlorine and arsenic.

7. Systemic poisons. Certain blood and nerve poisons, called systemic poisons, may be used in chemical ammunition. Examples are AC and CK.

8. Screening smokes are widely used in war for either spotting of artillery rounds or bombs, laying down of smoke screens to hide troop movements, or for antipersonnel effect. They are defined as agents that, when burned, hydrolyzed, or atomized, produce a dense obscuring smoke.

HC is a mixture of zinc dust, hexachlorethane, ammonium perchlorate, and ammonium chloride. It burns to form zinc chloride, a grayish white smoke, and it is used in base ejection and base emission artillery shell, bomb spotting charges, grenades, etc. Titanium tetrachloride (FM) and sulfur trioxide in chlorosulfonic acid (FS) are also used, the latter being called "fuming smoke." White phosphorus (WP) is the common smoke filler for bursting-type artillery projectiles. It melts at 110° F., and upon oxidation vigorous flames are produced, resulting in a white smoke cloud. In addition to its effect as a spotting and screening agent, WP is injurious to personnel and material.

9. Incendiaries are used primarily to set fire to material. Thermite (TH), the usual incendiary, consists of an intimate mixture of iron oxide and finely powdered aluminum. It burns with great rapidity and intense heat, and it furnishes its own oxygen.

Description and Types. CHEMICAL SHELL are similar to high-explosive shell and of the same general construction, except that the high-explosive filler is replaced by a chemical or smoke filler and a long central BURSTER TUBE is assembled into the same nose adapter as the fuze, as shown in Fig. 45A. The purpose of the burster is to just break open the shell when the fuze functions, so that the filler is definitely released (the shell is completely broken open without any unfragmented portions which might act as cups to retain portions of the filler), at the same time avoiding the type of action obtained with a high-explosive shell, which would prevent formation of a suitable cloud or proper dissemination of the filler. In fact, solution of this problem is a delicate balance between the forces involved. For the large-caliber chemical shell, a booster is used in addition to the burster.

Smoke Shell. SMOKE SHELL are important in trench or artillery warfare in three ways: as spotting charges to check on the range of artillery firing; to provide a smoke screen to conceal movements of troops from the enemy; and to serve as actual antipersonnel rounds, because small pieces

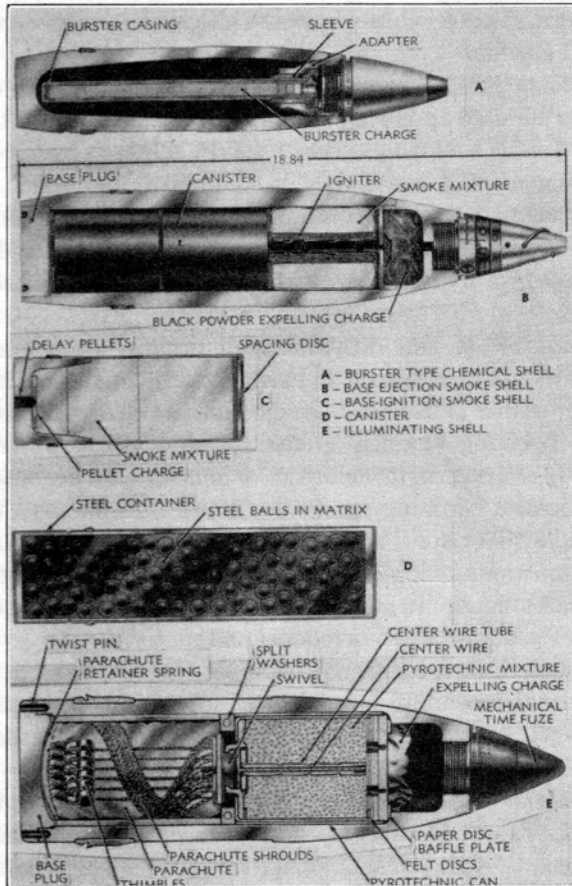

FIG. 45. Various artillery projectiles.

of burning phosphorus are sometimes as effective as actual shell fragments against personnel.

1. Bursting type. The BURSTING-TYPE SMOKE SHELL is a variety of chemical shell of the same construction but filled with white phosphorus instead of chemicals. The phosphorus is melted and poured into the shell under water. Since it melts at 110° F., a void may form in the shell, depending on the position in which the shell is stored, and poor ballistics will result. It is important that the void be the minimum possible.

Inasmuch as chemical shell filled with chemicals are not generally used in warfare, the bursting smoke shell is the most important variety of chemical shell.

2. Base-ejection type. The bursting-type smoke shell is only one kind of smoke shell. Another type is known as the BASE-EJECTION SMOKE SHELL, the smoke mixture being contained in canisters having an igniting mixture around the center of each canister. The shell is fitted with a time fuze which functions in the air a short distance from the ground, thus ejecting the entire shell contents by pushing out the shell base, which is threaded to the body by only a few threads engagement, followed by the canisters themselves which have been ignited at the same time. Ignition is accomplished by a black-powder expelling charge in the nose of the shell just to the rear of the fuze, as shown in Fig. 45B, which illustrates the essential parts of a typical base-ejection smoke shell. The burning canisters form a cloud of smoke as they descend, and they continue burning on the ground with satisfactory dispersion. The smoke mixture is usually hexachlorethane (HC), which is a powder forced into the steel canister under pressure.

Both the 105- and 155-mm. howitzers use base-ejection shell, including colored smoke in yellow, red, violet, and green, of the same general type shown in Fig. 45B.

3. Base-ignition type. In the BASE-IGNITION SMOKE SHELL, the smoke mixture is ignited as the projectile leaves the gun, the smoke streaming from the rear of the shell. The ignition is accomplished by the hot propellant gases consuming a thin metal disc and passing through a vent hole in a plug to an igniting pellet, after which the plug, which is made of low-melting-point alloy, melts and allows the smoke to stream out through the hole so formed, and continues to burn after impact. A typical base-ignition shell is shown in Fig. 45C. The disc and plug have been replaced in this design by igniting smoke composition, pressed into the opening, which is ignited by the propellant gases. Base-ignition shell, sometimes called base-emission shell, are used in 75- and 76-mm. sizes.

10. Armor-Piercing Projectiles.

Description and Types. The designer of armor-piercing projectiles and weapons to fire them has always played a game with the designer of armor and armored units, such as tanks, armored vehicles, and even aircraft armor. No sooner had the armor designer thickened up his plate or heat-treated it a little better (consistent with mobility of the unit he is trying to protect) than the projectile and gun designer immediately thought of something to penetrate such armor, such as higher

muzzle velocity resulting in higher striking velocity, or better heat-treated projectiles, or shaped-charge projectiles. This process has resulted in a number of different types of armor-piercing projectiles, as follows:

- AP SHOT.** Solid projectile without explosive charge or fuze, with or without an armor-piercing cap, and with or without a false ogive or windshield. Projectiles with caps are called APC shot.
- AP PROJECTILE.** Almost solid projectile with small explosive charge and fitted with a base detonating fuze, usually with an armor-piercing cap and windshield, and therefore referred to as an APC projectile.
- HEAT SHELL.** A high-explosive, antitank projectile, applying the shaped-charge principle, with windshield and either base detonating or point fuze.
- HVAP SHOT.** A high-velocity, armor-piercing shot, without explosive charge or fuze, but having an extremely hard core.

In general, the weight distribution of an APC projectile is as follows: body, 75%; cap, 11%; windshield, 3%; base plug, 4%; band, base cover, charge, and fuze, 5%; other parts, 2%.

AP Shot. The term "AP shot" is generally understood to mean a solid shot without explosive charge or fuze. Such a shot must be made of specially heat-treated alloy steel, usually of the molybdenum-chromium variety, decrementally hardened to form a very hard nose to stress the plate at impact, and a body not quite so hard so that the main shot body will pass through the plate without breaking up. The nose of the cap of a three-piece shot might have a hardness of Rockwell C60 tapering to C18 at the cap base where it merges with the projectile ogive; the shot nose might have the same hardness as the cap nose, decreasing to C22 at the shot base. Hardness requirements are not prescribed on the drawings, but the hardnesses referred to above are the approximate values with which satisfactory penetration has been obtained. Penetration and not a particular hardness is the requirement the manufacturer must meet. The hardened nose was made necessary by the development of face-hardened plate, much more difficult to defeat than homogeneous steel plate. Plate penetration depends to a large extent upon striking velocity and angle of impact, normal impact being more conducive to penetration, and tank designers have inclined much of the tank armor at angles, making it difficult for high-velocity anti-tank guns firing projectiles at flat trajectories to hit armor at anywhere near normal impact.

SOLID SHOT are usually restricted to calibers below 105 mm., principally 20, 37, 40, 57, 75, and 90 mm., and 3 in. Figure 44C shows a typical solid shot of the one-piece variety. On some of the smaller-caliber shot the bourrelet extends from the ogive to the rotating band, which is fairly wide and fitted with a groove in the center. The shot has no boattail, primarily because a boattail is beneficial on lower-velocity projectiles, especially when the velocity is below that of sound, say under 1100 ft./sec. The base of the shot has a tracer cavity, the tracer allowing the path of the shot to be followed so as to direct the fire better. In three-piece shot almost the entire portion of the shot ogive is covered by the cap, so shaped as to maintain a smooth contour, and made of hardened heat-treated alloy steel, and either soldered or sweated to the ogive. The windshield is added to the cap solely for ballistic reasons; it collapses when the shot hits the plate. It is either screwed directly to the cap or held on with a small ring adapter. The theory is that the cap stresses the plate initially and starts penetration, breaking up in so doing, then the main body of the hardened shot can start its work without having been broken up or weakened by the initial contact.

Two-piece shot have the windshield attached directly to the shot body, and are considered by some to be as effective as three-piece shot, particularly for larger caliber weapons, such as 90 and 105 mm.

AP Projectiles. The term AP projectile is applied to armor-piercing projectiles having an explosive charge as shown in Figs. 44A and B. Of course, the cavity for this explosive charge cannot be large, and it must be in the base of the shell, as otherwise the nose would not be sufficiently strong to penetrate armor. The charge seldom exceeds 5% of the total shell weight, the shell being base fuze, usually with a tracer. AP projectiles are usually of three-piece construction, like three-piece shot, and were originally designed for seacoast guns of caliber 6 in. and larger for firing against ship armor. AP projectiles are used primarily against tanks and other resistant land targets. Insensitive explosives are used so that detonation will not result because of the shock of impact, thus allowing armor penetration by delay action of the fuze behind the plate. AP projectiles have now been developed for smaller caliber, down to as low as 57-mm.

AP projectiles are base-fuzed. Since point-fuzed projectiles are fitted with a base plate of steel welded or brazed to the base of the shell to protect the high-explosive charge from the hot propelling gases in the event of some porosity through the base section of the shell, Fig. 46a, the question arises as to how base-fuzed projectiles are sealed.

Medium-caliber projectiles having the M66- and M68-type fuzes are sealed by means of a lead ring over which a copper sealing ring is placed,

and the two are caulked into a groove, as in Fig. 46b. The M60-type fuze for large-caliber projectiles fits flush into the rear of the projectile and is sealed with a lead disc, over which a copper cover is placed, and the two are fastened to the base by caulking a lead ring into the groove, as in Fig. 46c.

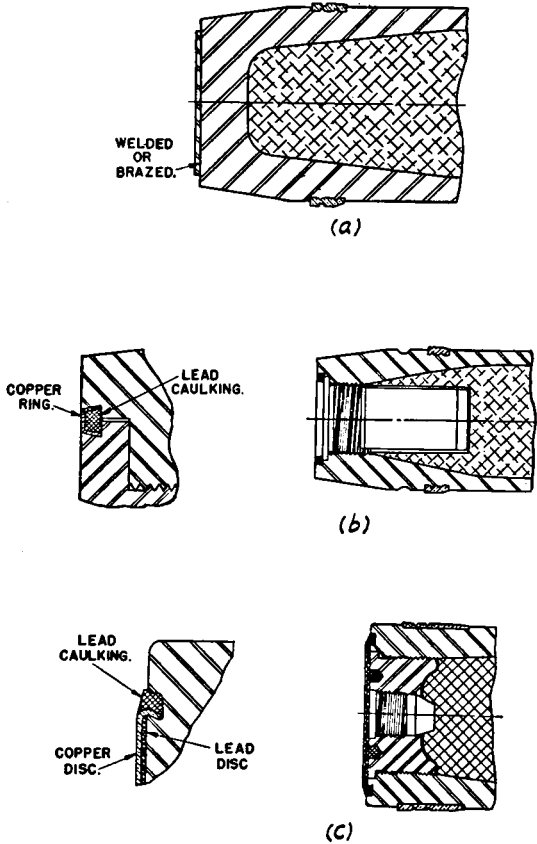

FIG. 46. Methods of sealing projectile base.

HEAT Shell. The principle of the shaped charge has been successfully applied to armor-piercing projectiles, which are fuzed in such a manner that the detonation wave will originate from the rear and travel towards the liner to initiate jet action properly. Such a projectile is called a HEAT PROJECTILE, meaning high-explosive-anti-tank projectile. Since it is desirable to have the explosive column at least several calibers in length, which space is usually not available, the base fuze and booster should be fairly short. The liners of the standard 75- and 105-mm. shaped-charge projectiles are steel cones of material

about 0.1 in. thick with an included angle of about 42° , and they are attached to the front of the shell by an adapter which also holds the windshield. The purpose of the windshield is to improve ballistics, but the windshield is made as thin as possible so as not to interfere with jet penetration and yet to provide sufficient retardation to effect fuze functioning at the proper distance from the target.

Pentolite (50/50) serves as a filler for HEAT shell because of its high rate of detonation and ease of initiation. Although it would be desirable to do so, 50/50 pentolite cannot be used near the base because it is too sensitive to be drilled out to form the fuze cavity, and 10/90 pentolite is therefore loaded as a top-off to the 50/50. Cyclotol has possibilities as a filler for HEAT shell, and other experimental explosives are being tried.

A typical base-fuzed HEAT shell is shown in Fig. 44E. However, because a base fuze has some inherent delay action because of the necessity of having an inertia-type plunger, unsatisfactory results are obtained on short small-caliber HEAT projectiles because detonation does not take place until after the liner has reached the target, and some definite stand-off distance is necessary. Therefore it is highly desirable to start initiation from the front end at the instant of impact and to transmit the impulse to the rear end, so that the detonating charge may be initiated from the rear but much faster than by base-fuze action. But, in order to do this, a passageway must be provided from front to rear, and a passageway removes the central part of the shaped charge and liner, thus reducing the efficiency of the jet. The problem is therefore to ascertain whether the advantage of front-end initiation more than offsets the removal of part of the shaped charge and liner. For the 57-mm. HEAT projectile, a definite advantage was found. The principal components of a point-initiated shaped-charge projectile are shown in Fig. 42.

HVAP Shot. Another type of AP shot is known as the HVAP SHOT, an abbreviation of the phrase hyper-velocity-armor-piercing shot. It is characterized by an extremely hard tungsten carbide core set inside the body of the shot and by the fact that it is fired at very high velocities, up to 4000 ft./sec. A typical shot of this variety is shown in Fig. 42. The body, nose, and windshield may be made of lightweight material like aluminum, the base being of steel and fitted with a tracer. The theory is that the core is really a very hard projectile of high density and has a high velocity imparted to it because of the use of a powder charge of a larger-caliber gun, much more than a projectile of the caliber of the core itself would normally have, and because the assembled shot weighs less than the usual projectile of the same caliber but has good

ballistics. The rotating band is usually of steel because of the high bearing pressures.

This type of shot has become popular recently in calibers 3 in. and 76, 90, and 105 mm.

Penetration. The amount of penetration obtained against armor depends upon the relationship between the quality of the shot and the quality of the plate. Some of the characteristics of the plate and shot which affect penetration are thickness and heat treatment of the plate and velocity, angle of impact, heat treatment, and shape of the shot. The plate may be homogeneous or face-hardened. The shape of the nose of the shot, whether it is fairly blunt or has a cap to "bite" into the plate, etc., is also a factor. Because there are so many factors, it happens frequently that one manufacturer of shot can pass the required ballistics test by obtaining complete penetration of face-hardened plate and another will fail.

In general, AP shot and AP projectiles are expected to penetrate face-hardened plate of thickness about equal to their caliber, and this penetration is sometimes called "caliber penetration." Of course, the angle of impact, striking velocity, and plate condition are important factors. More penetration of homogeneous plate is expected, and penetration of $1\frac{1}{2}$ calibers is not uncommon. The armor-piercing cap is usually considered to be more effective against face-hardened plate than against homogeneous plate because the cap serves to absorb the initial shock against the face-hardened surface, whereas against homogeneous plate the cap might actually add to the thickness to be penetrated.

The monobloc shot without cap is therefore effective against homogeneous plate at high angles of impact, such as the 55° armor of the German Panther tank. It is difficult to make a rule regarding penetration, but the consensus of opinion at present seems to be that APC shot will penetrate face-hardened plate somewhat more easily than homogeneous plate, and that the reverse is true for monobloc shot without a cap.

HVAP shot are expected to penetrate up to 3 calibers of face-hardened plate, because of the extremely high velocity and the hardness and density of the core.

Now, when we discuss penetration of HEAT projectiles, a different kind of phenomenon has to be considered. Since it is known that under ideal conditions (static test with optimum stand-off, rear initiation, proper length of explosive column, accurately made parts, etc.) we get a penetration of 4 to 6 times the caliber, the problem is to approach these conditions as nearly as possible ballistically. The effect of spin is to reduce the penetration up to $\frac{1}{2}$; inaccurately made parts, such as a liner of uneven thickness or off center, will further decrease penetration;

improper stand-off distances at the instant of detonation are detrimental. So we usually end with a projectile that gives us penetration of about $1\frac{1}{4}$ to $1\frac{3}{4}$ caliber, still much better than ordinary shot penetration. Of course, the hole is smaller, being burned through by a jet, and the material which goes through the hole is in the form of hot gases and hot gaseous particles rather than comparatively large pieces.

Up to 60° angle of impact AP, APC, and HEAT projectiles are all effective. One theory is that APC projectiles may be somewhat better because the cap "bites" the plate and tends to give penetration more nearly normal to the plate. Of course, AP and APC projectiles have a better chance of hitting the target because of their better trajectories. The HEAT projectile must be fired from a low-velocity weapon like a howitzer, at 1000 ft./sec. or less, although faster fuzes may permit higher-velocity HEAT projectiles.

11. Canister.

The type of projectile known as CANISTER consists of a quantity of lead or steel balls encased in a matrix of rosin and a metal container. This container is composed of three segments held together by a thinterneplate case soldered to the front end disc. A bead is formed on theterneplate case to position the canister in the cartridge case, and a crimping groove is provided for attachment of the canister to the cartridge case. The size and number of balls are determined empirically, the size being neither too large nor too small, as is true of shell fragments. The 37-mm. canister has 122 lead balls. It is considered that steel balls cause erosion in the bore more quickly than lead balls.

Canister is employed to clear out underbrush and foliage in jungle warfare and against personnel at fairly close range. It is also used in tank weapons against attacking personnel. Originally developed in the 37-mm. size, a series of canister is now available in a range of calibers, including 37, 57, 75, 76, 90, and 105 mm. Figure 45D shows a typical canister.

12. Practice Projectiles.

PRACTICE PROJECTILES are for training troops. They may be similar to high-explosive projectiles having the same ballistics except that they are inert loaded and are fitted with dummy fuzes. Other practice projectiles are loaded with a spotting charge for spotting the point of impact and for adjustment of fire. The spotting charge may be black powder or black powder mixed with graphite. The remainder of the cavity not taken up by the spotting charge is inert loaded. A practice projectile with a spotting charge is shown in Fig. 42.

13. Drill, Training, and Proof Projectiles.

DRILL PROJECTILES are totally inert projectiles, of approximately the same size and weight as service projectiles, as shown in Fig. 47A, to train gun crews in going through the motions of loading and firing without actually firing. In this day of automatic loading of artillery weapons, drill projectiles are not used as extensively as formerly.

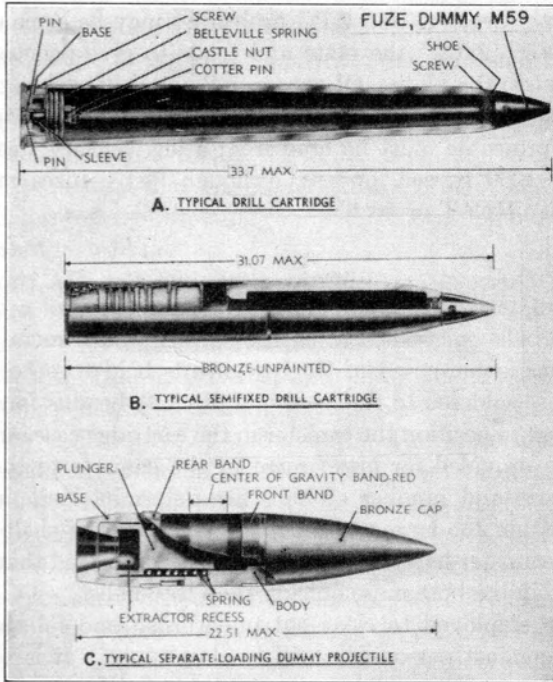

FIG. 47. Various artillery projectiles.

Smaller drill projectiles may be made from service projectiles rendered inert as in Fig. 47B, but drill projectiles for separate-loaded ammunition usually have an arrangement for loosening the projectile from the breech, such as an internal plunger which snaps back by spring action after ramming, thus facilitating removal of the projectiles, as in Fig. 47C.

Drill projectiles are sometimes called DUMMY PROJECTILES.

A PROOF PROJECTILE is also an inert projectile, either solid metal or inert loaded, but it must be of the exact weight of the service projectile it is supposed to simulate because it is used to proof fire weapons and establish powder charges. It may be made of any suitable metal, but is usually steel, and its shape is not too important since external ballistics are not a factor.

TRAINING PROJECTILES are similar to drill projectiles, being completely inert; they are used to train troops in handling ammunition. Some training projectiles, however, are actually fired from weapons. The 81-mm. mortar training projectile is typical.

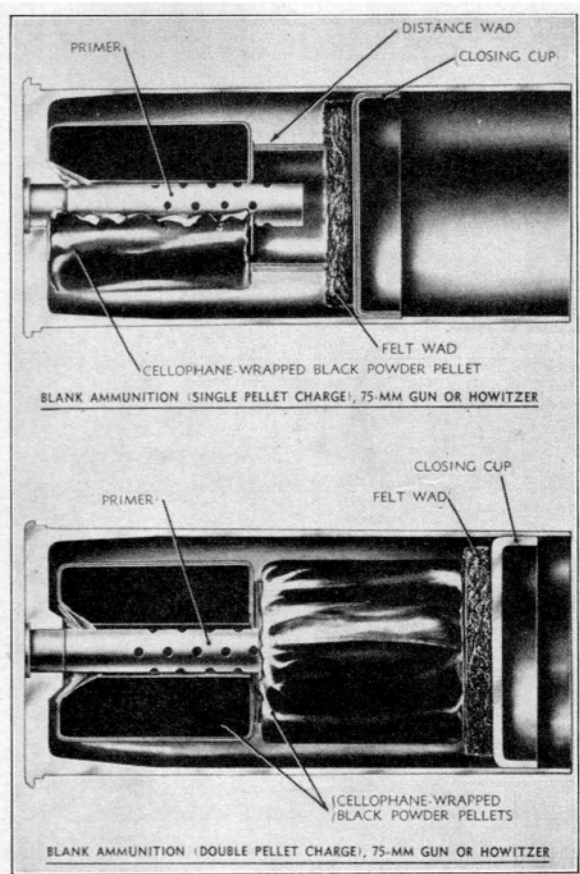

FIG. 48. Artillery blank ammunition.

14. Blank Ammunition.

In **BLANK AMMUNITION** there is no projectile, a short cartridge case being loaded with a black-powder charge contained in a bag or in the form of pellets, and held in the case with a closing plug sealed in the mouth. In some of the smaller-caliber blank ammunition a shotgun blank cartridge assembled in an adapter takes the place of black powder contained in bags or as pellets. Blank ammunition is made in 37-, 75-, 90-, and 105-mm. and 3-in. sizes; it is used primarily for saluting. A typical blank cartridge is shown in Fig. 48.

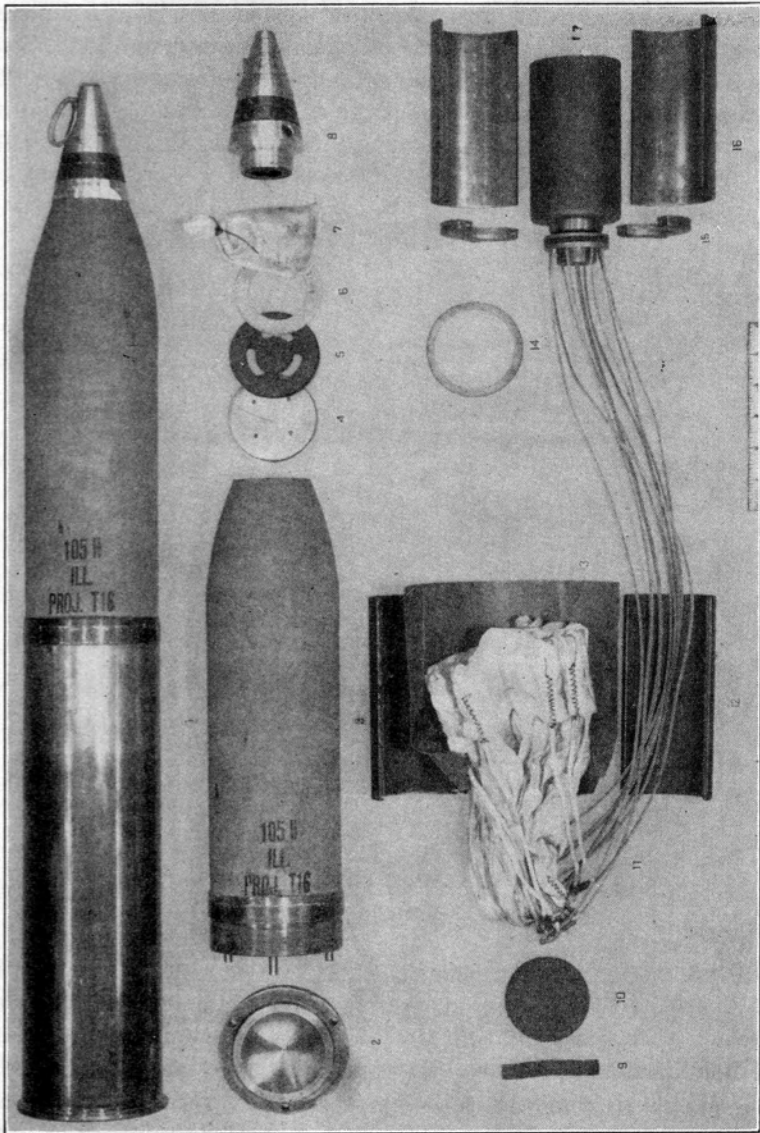

FIG. 49. Components of 105-mm. illuminating projectile.

- | | |
|-----------------------------------|------------------------------------|
| 1. Complete round. | 10. Felt disc. |
| 2. Base plug. | 11. Parachute. |
| 3. Shell body. | 12. Steel lower support. |
| 4. Steel baffle plate. | 13. Paper wrapper. |
| 5. Baffle gasket. | 14. Fiber washer. |
| 6. Fiber baffle spacing washer. | 15. Steel split washer. |
| 7. Black powder expelling charge. | 16. Steel upper support. |
| 8. M54 fuze. | 17. Illuminant container assembly. |
| 9. Spring clip. | |

15. Illuminating Projectiles.

These projectiles are fired from guns for the purpose of illuminating enemy territory or advancing enemy troops, and by the Navy for shooting over ships to silhouette them as targets at night. The shell bodies are similar to high-explosive shell, having a bourrelet, rotating band, and ogive, but no boattail. The shell walls are straight so that the illuminant and parachute assemblies may be ejected as soon as the three copper shear pins holding the base are sheared, which is accomplished by the expelling charge pushing on a front end disc. The illuminant assembly is ignited by the expelling charge at the same time that it is ejected. Illuminating shells rotate at high speeds, and the illuminant assembly must continue rotation after ejection while the parachute assembly stops rotating in order that the parachute may not be torn. These requirements are met by placing a ball-bearing swivel between the two assemblies. Figure 45*E* shows a typical illuminating projectile, and Fig. 49 shows the parts for the 105-mm. projectile.

Navy-type illuminating projectiles are used by the Army in sizes from 3 in. up, and they are all of the same general construction. The height of burst is usually just over the peak of the trajectory, and in the 3-in. the illuminant burns for 20 sec. with a candlepower of 200,000.

MORTAR PROJECTILES

16. General Description.

MORTAR PROJECTILES are somewhat different from artillery projectiles in that they are either of the so-called tear-drop shape or are cylindrical. Most mortar projectiles are of the fin-stabilized variety for use in smooth-bore weapons, and provision is made in the base of the projectile for attaching the fin assembly, usually by screwing it into a threaded cavity in the rear of the projectile. Mortar projectiles are somewhat lighter in construction than artillery projectiles, because the chamber pressures and setback forces are much less. Smooth-bore projectiles have no rotating band, and they contact the bore at two places, sometimes three, one being a series of machined bands called the GAS CHECK, and another being the outside portion of the fins for the tear-drop shape and cylindrical shape, plus a front bearing surface for the cylindrical shape. The gas-check area is near the front of the tear-drop-shape projectile at the maximum diameter and is near the rear of the cylindrical projectile.

The principal types of mortar projectiles are high-explosive, chemical, smoke, and illuminating; they are point fuzed. The low muzzle velocity, higher trajectory, and lack of extreme accuracy preclude the use of

mortar armor-piercing projectiles. Smooth-bore mortars come in sizes 60, 81, 105, and 155 mm., and the rifled-bore mortar in use is the 4.2-in. chemical mortar, originally developed as a smoke projector by the Chemical Warfare Service and now employing high-explosive ammunition as well.

The tendency since 1941 has been towards larger-caliber mortars, primarily because of their mobility, and because they, together with rockets, are so well adapted to island warfare. Mortars up to 10 in. in size are under development.

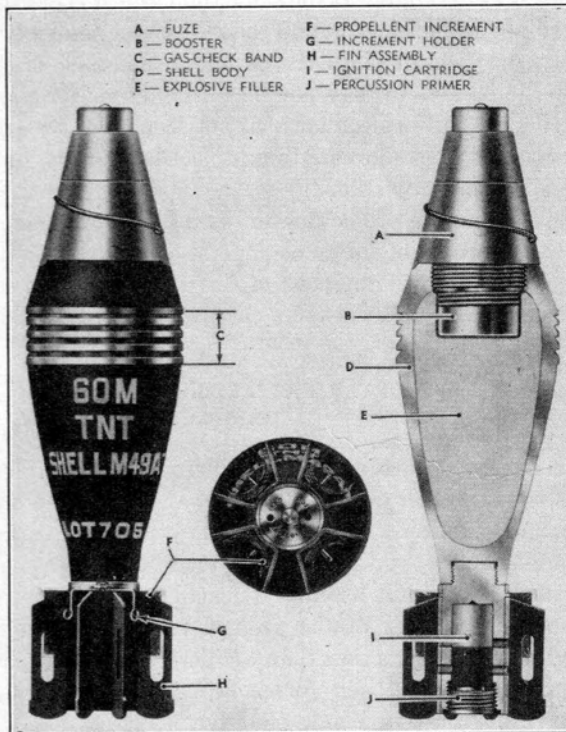

FIG. 50. Tear-drop-type mortar round.

17. Smooth-Bore Mortar Projectiles.

High-Explosive Projectiles.

1. Tear-drop type. This type of mortar shell is made for 60-, 81-, 105-, and 155-mm. weapons. A typical shell is shown in Fig. 50. It is made from a forging, steel casting, or plate welded longitudinally, except that the large sizes are almost always forgings. The shell body has an ogive blending into the fuze contour, a machined bourrelet just back of the

ogive replacing the rotating band and acting as a bearing surface and a gas check, a tapered tail ending in a heavier section or the rear bored out and threaded to contain the fin assembly, and a threaded nose fuze cavity.

The tear-drop variety of 60- and 81-mm. mortar shell is the lighter-weight shell used for fragmentation and blast effect, and the explosive capacity is about 15%. Because of the low velocity and light weight of the smaller sizes not much penetration is obtained.

The streamlined projectile for the 105- and 155-mm. mortars is essentially of the tear-drop shape, having a machined bourrelet near the nose and threaded at the rear for the fin assembly and at the nose for the fuze. The capacity is about 35%, somewhat greater than the tear-drop projectiles for the smaller mortars, and both demolition and fragmentation effects result. Figure 97 shows a complete round for the 155-mm. mortar.

2. Cylindrical type. This type of mortar shell is used for the 81-mm. mortar only; although larger and heavier, it has thinner walls so that demolition more than fragmentation is accomplished. The shell is a high-capacity one, about 40%, and consists of a nosed-in cylindrical body of steel tubing with nose adapter for fuze, long tapered boattailed

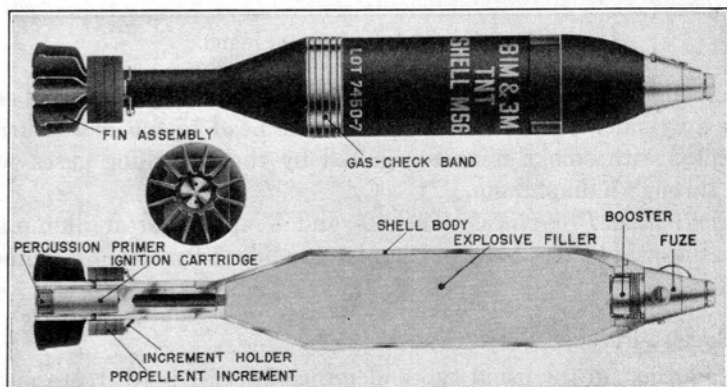

FIG. 51. Cylindrical-type mortar round.

base, drilled and threaded to hold the fin assembly, rear gas check and bourrelet just ahead of the tail cone, and three raised bearing surfaces just back of the ogive to support the round in the bore at the front end. The tail cone of this shell must withstand the pressure of the propellant gases, and dents are objectionable even if failure of the cone does not take place, because ballistics will be upset. Figure 51 shows the 81-mm. cylindrical projectile, M56.

Chemical and Smoke Projectiles. Smooth-bore mortar chemical and smoke projectiles are cylindrical in shape and consist of the usual point fuze, adapter, burster, and chemical or smoke filler, such as shown in Fig. 52. The problems of design are the same as for chemical and bursting-type smoke artillery projectiles in that just the right amount of bursting force is required in order that the filler may be forced out of the shell yet not scattered too much.

Chemical and smoke shell are provided for the 60- and 81-mm. mortars, and, in addition, a small 2-in. smoke mortar is mounted on a

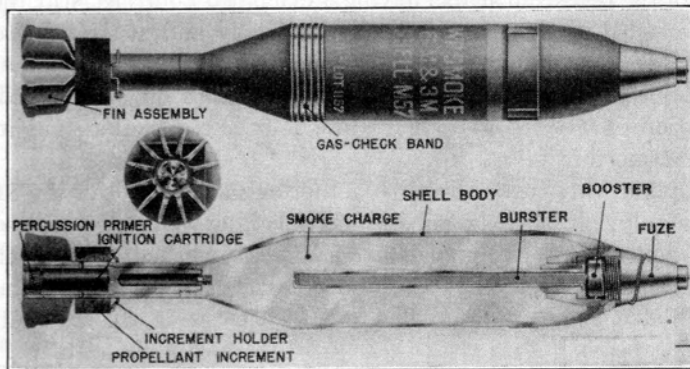

Fig. 52. Chemical mortar round.

tank, similar to the British 2-in. bomb thrower. This projectile is essentially a cylinder 6 in. long, enlarged at the head to act as a bourrelet, and filled with smoke mixture, ignited by the propelling gases which burn through a diaphragm.

Illuminating Projectiles. The 60- and 81-mm. mortar illuminating projectiles will be discussed in Chapter 10 under "Pyrotechnic Ammunition."

18. Special-Purpose Projectiles.

In addition to the usual types of projectiles discussed, there may be requirements for special-purpose projectiles. A mortar-projected grappling hook has been developed by replacing the nose and fuze by a pipe having long steel barbs on it, with a ring in the end to which a long cable is attached. The device, fired from the 81-mm. mortar, reverses itself just out of the mortar so that the cable is unreeled, and, after landing, the cable is hauled in, the barbs catching on barbed wire or entanglements, thus clearing a beach or landing strip.

The 81-mm. mortar projectile has also been modified by cutting it in two parts and attaching each part to a long bangalore torpedo tube, so

that an elongated projectile over 5 ft. in length results. Although it projects from the mortar muzzle before firing, it gives fair ballistics and hits nose down.

A mortar-projected land anchor has been developed by screwing an anchor with a cable attached to it in the nose of the standard 81-mm. mortar projectile in place of the fuze. It can be used to anchor small landing craft.

The 60-mm. illuminating shell has been modified to contain propaganda leaflets, which are expelled when the shell functions in the air in the usual way. This same shell has been modified to disseminate a finely divided metallic material for radar purposes. Many other varieties are possible by modification of existing types.

CHAPTER 6

ARTILLERY FUZES AND BOOSTERS

1. General.

A FUZE is a mechanism or device for controlling the ignition or detonation of a projectile. By controlling the burst we mean that not only the time of ignition or burst, but the character as well, is controlled. A fuze is a sort of brain traveling along with the projectile and controlling its actions; considered from that standpoint, it is the most important part of the projectile, although each part of a round has its own mission to perform for proper projectile functioning.

Because of all the things a fuze must do, it is the most complicated part of a round. It must have sufficient strength to withstand the forces of setback in the gun, and any forces of impact up until the instant it is supposed to function; it must arm at the proper time outside the gun, yet function reliably without duds or prematures; it must be contained in a housing or body of such a size and shape as to fit the shell and be sufficiently streamlined to provide proper ballistics, yet contain all the elements, including the explosive train, required for functioning; and it must be easy to manufacture, load, and assemble, foolproof against malassembly, easy and safe to pack and ship, and not subject to deterioration on being stored for many years.

A BOOSTER is a mechanism or device for amplifying the fuze portion of the explosive train, necessary in order to insure high-order detonating of the comparatively insensitive shell bursting charge. Although sometimes made in a separate housing, it is usually the rear portion of the fuze and either screwed to the fuze or made an integral part of the fuze body. Boosters that have their own arming features may be considered "auxiliary fuzes," and it is generally agreed that American fuzes are perhaps overdesigned for safety, if such is possible.

2. Detonator Safety.

The conception of detonator safety in our fuzes and boosters is fundamental. The requirement of detonator safety is one of the factors that makes our fuzes complicated. A fuze or booster is said to be DETONATOR SAFE when the explosive train is physically interrupted so that, if one of the sensitive explosive elements should accidentally or spontaneously fire during handling, storage, or even in the gun bore, premature ex-

plosion of the shell is prevented. Detonator safety is accomplished by keeping a detonator, booster lead, or some element below which are no initiator-type explosives, out of line with the rest of the explosive train until the projectile is outside the gun. The actual mechanism for doing this will be discussed under fuze arming and in the descriptions of typical fuzes.

A fuze that is detonator safe is automatically **BORE SAFE**, because detonator safety embraces safety at all times even in the bore. However, the term "bore safe" is sometimes applied to fuzes that do not actually have the out-of-line feature but that give no trouble in the bore (in other words, owing to their design, have never prematured).

3. The Fuze Explosive Train.

The explosive train in the artillery fuze consists of a very sensitive initiator explosive element called a primer, which is functioned by stab action of a firing pin or by crushing action against a resistant target; a detonator, which picks up the primer impulse and amplifies it so that the booster may be properly initiated; the booster, which is not as easily initiated as the detonator and which requires a fairly powerful detonator to initiate it, but which further amplifies or "boosts" the detonating wave so that the comparatively insensitive bursting charge may be initiated high order.

The detonator initiated by a primer is called a **FLASH-ACTION DETONATOR**. The primer and detonator may be combined by adding a sensitive primer mixture to the front of the detonator so that the detonator is functioned directly by a firing pin, such a detonator being called a **STAB-ACTION DETONATOR**. The construction and constituents of primers and detonators are discussed in Chapter 3.

Sometimes a delay is necessary in the explosive train; if so, it is usually a black-powder pellet just after the primer and before the detonator. However, it is necessary to add a **RELAY** after the **DELAY**, in order to insure high-order detonation of the detonator, because the flash from a small black-powder delay element is rather weak. Furthermore, the small chamber in which the delay is located is sometimes sealed or obturated so that burning in it may be closely controlled, resulting in uniform delay times. This sealing is called **OBTURATION**, and it necessitates a primer at one end of the chamber which provides a seal even after it is fired, as explained in Chapter 3. The primer must be carefully chosen so that its impulse is sufficient to definitely ignite the delay without blasting any of it away, and the primer gas volume must be uniform so as not to affect the burning rate of the delay element in obturation cavity.

4. Forces in Gun Affecting Fuze Action.

Before discussing fuze arming, let us consider the forces that exist in the gun, during flight and at impact, with which the fuze designer not only contends but which he may actually employ in his design to control fuze behavior. These forces are:

(a) The tremendous linear acceleration to which the fuze is subjected as the propellant powder gases expand, popularly called **SETBACK**.

(b) The tremendous rotational acceleration imparted to the projectile as it is accelerated through the rifling.

(c) Centrifugal force due to **ROTATION** in the bore.

(d) Centrifugal force due to continued rotation outside the bore.

(e) A gradual rotational deceleration due to wind resistance outside the bore (the projectile is still rotating very fast when it hits the target).

(f) A gradual linear deceleration due to wind resistance, popularly called **CREEP**, the result of which is that any free parts inside the fuze tend to creep forward during flight because of their own inertia.

(g) The tremendous linear deceleration at impact, which may be even greater than linear acceleration in the gun, especially for armor-piercing projectiles.

5. Requirements of a Satisfactory Fuze.

In Art. 1, some broad requirements for a fuze were discussed, but here we will list the actual requirements for a satisfactory fuze.

Dependability and Accuracy. By this we mean that the fuze can be depended upon to function properly every time, and that it functions accurately—gives the proper delay, functions exactly as set, gives the type of ignition or detonation expected, with no prematures or duds. A fuze that is not dependable is no fuze at all.

Safety. Safety is considered of as great importance as dependability. A fuze must be safe to manufacture and load, safe against bumps and drops during handling and transportation, safe to store without dangerous deterioration or decomposition of the explosives alone or in contact with metals, detonator safe, and safe to withstand the forces in the gun and of firing. It is this requirement that makes our fuzes complicated.

Interchangeability. Fuzes should be interchangeable ballistically; that is, as many of our fuzes as possible should be of the same weight and contour and have the same threads for screwing them into projectiles. This interchangeability allows one projectile to be fired with a superquick fuze, and the next with a time fuze, with no change in the gun setting and by reference to the same range table. Also, as far as possible, component parts should be interchangeable to keep the number of different parts to a minimum, a corollary concept of mass production.

Adaptability to Mass Production. In the United States, no fuze can really be considered of satisfactory design if it does not lend itself to production in large quantities. Although fuzes are not exactly simple in construction, they should be kept as simple as possible consistent with functioning and safety requirements. Such items as inaccessible drilled and counterbored holes, difficult threading operations, loading of explosives in inaccessible cavities, parts and assemblies not lending themselves to ready inspection, etc., must be avoided.

6. Classification of Fuzes.

Fuzes are classified as follows:

- (a) According to assembled position in the projectile.
 - BASE-DETONATING FUZE—assembled in rear of projectile.
 - POINT-DETONATING FUZE—assembled in nose of projectile.
- (b) According to time of functioning.
 - IMPACT FUZE—function at impact with target.
 - TIME FUZE—function in the air at expiration of predetermined time.
 - COMBINATION FUZE—a combination of impact and time fuze, or of two actions at impact.
- (c) According to specific action at functioning.

Table 11 is self-explanatory and shows the relationship between different fuze actions, how they are obtained, and the general tactical result.

TABLE 11

FUZES CLASSIFIED ACCORDING TO SPECIFIC ACTION AT TIME OF FUNCTIONING

<i>Name</i>	<i>Type</i>	<i>Action and How Obtained</i>	<i>Tactical Result</i>
SUPERQUICK	PD	Fastest fuze action possible because firing pin in nose of fuze hits target and functions with no retardation of fuze or shell; because firing pin is in nose, a superquick fuze is necessarily a point fuze.	Burst on surface of target; no crater except on very loose sand or soil due primarily to blast action; no penetration of resistant targets.
NON-DELAY	PD or BD	Inertia of plunger-type firing pin inside body of fuze causes firing pin to move forward and function fuze and shell; requires considerable retardation before fuze acts, equivalent to an inherent delay of several milliseconds. This is fastest action obtainable in base fuze and may be used in point fuze.	Small crater on medium soil; a little penetration of hard surfaces, but still not slow enough for armor penetration; would burst some feet behind wood screen.

TABLE 11—*Continued*

FUZES CLASSIFIED ACCORDING TO SPECIFIC ACTION AT TIME OF FUNCTIONING			
<i>Name</i>	<i>Type</i>	<i>Action and How Obtained</i>	<i>Tactical Result</i>
SUPERSENSITIVE	PD	Same as superquick with firing pin in nose but free floating when armed; can be pushed in at slightest touch, unlike most PD fuzes which have a small copper cup or equivalent under firing pin.	Surface burst on extremely light targets such as aircraft wing or strut, branch of tree, etc.; intended primarily for antiaircraft work.
SHORT DELAY (say 0.05 to 0.25 sec.)	PD or BD	A definite short delay inserted in the explosive train, usually a black-powder pellet in either point or base fuzes.	Definite crater action depending on soil and delay; definite penetration of resistant targets, including armor; will give air burst on ricochet action or graze impact.
TIME (Long delay, say $\frac{1}{2}$ to 70 sec.)	PD	Either a powder delay train in explosive train or a mechanical clockwork which releases firing pin.	Air burst against personnel in trenches or foxholes; antiaircraft; high-burst ranging.

7. Fuze Materials.

Fuze bodies are made from steel, brass, aluminum, or plastics. Base-detonating fuzes in the rear of projectiles, particularly those with a delay, are made of steel so that the fuze will stay together and function even though the projectile is being deformed by armor plate. The light non-delay 37-mm. base fuze is made from brass.

Very small point fuzes, such as the 20-mm., may be made from brass or steel. Other point fuzes under 75 mm. are made from aluminum or steel, the aluminum providing sufficient strength for quick action as soon as the target is hit. Point fuzes for 75 mm. and above are made from steel, with a brass booster, the steel body being necessary to house the delay element and prevent breaking up of the fuze while the delay is acting. Of course, the front end of such fuzes may be of brass because with superquick functioning the action is faster than deformation of parts.

Time fuzes need not be of steel, because they are not required to withstand the stresses of target impact; they are made from brass or aluminum. Zinc or aluminum die castings are also suitable, as the principal stresses involved are usually due to assembly in tightening the time train rings.

Mortar fuzes have been made of aluminum whether they are of the superquick or delay type, but the present tendency is to make delay

fuzes of steel. Larger-caliber mortar fuzes of the combination superquick and delay variety are made entirely of steel. The superquick mortar fuze is now made from plastics because stresses due to mortar setback are low and because even instantaneous break-up of the fuze on impact does not affect superquick action. This is about the only place plastics have so far been found satisfactory in fuzes, except for certain small parts, such as closing plugs or discs, and in dummy fuzes which do not function. Plastics have alleviated the aluminum-shortage problem.

FUZE ARMING

8. Definition.

A fuze is said to be ARMED when it is ready to function. Arming corresponds in a rough way to cocking in a small arm. By inference, therefore, arming consists of all the phenomena or events that must take place before a fuze is ready to fire. The actual firing or detonating takes place after arming, either in the air or at impact, but in either event at the target. Arming, on the other hand, takes place in and just outside the weapon, preferably outside, but it should never be completed until the fuze is outside the bore.

9. How Accomplished.

Arming is accomplished by utilizing forces, existing in or outside the gun, which are described in Art. 4. Centrifugal force is employed to cause pins, plugs, or balls to move outwards, sometimes against springs; setback force (linear acceleration) is used to cause pins or plungers to remain at rest relative to the body of the fuze which moves forward; rotors containing out-of-line detonators are so designed that their center of gravity tries to move as far from the fuze center of rotation as possible, thus lining up the detonator with the balance of the explosive train; sliders containing out-of-line elements are usually inclined at such an angle that they will not move while both setback and centrifugal forces are acting but will line up their elements when centrifugal force alone is acting; centrifugal and setback forces are also sometimes used together so that a firing pin on a fulcrum will not line itself up as long as both forces are acting but will do so after the force of setback has ceased. A large number of such combinations of mechanical arming features is possible, but they all utilize one or more of these forces and can be analyzed from that viewpoint. Typical arming systems will be discussed as individual fuzes are described.

Because centrifugal force decreases as the rotational velocity decreases during flight, the method of holding sliders, rotors, etc., in the

armed position is a problem. It is solved either by locking them in the armed position, or by taking advantage of the fact that even though the speed of rotation has decreased the moment arm has increased because the center of gravity is farther from the center of rotation, with the result that sufficient torque is still present to keep them armed.

10. Further Arming Considerations.

Obviously, the purpose of fuze arming is to make fuzes safe. The fact that the arming events have to take place means that fuzes should be safe to transport and handle because forces encountered in handling are generally less than, or at least of a different nature from, those encountered in actual firing. This statement is not always true, particularly where rotational forces are absent as in smooth-bore weapons, or where setback forces are small as in mortars, howitzers, and rockets. Therefore, certain other precautions need to be taken which may be considered part of the arming phenomenon, such as the addition of a pull pin usually attached to a ring for easy withdrawal. Thus, the original booster for large-caliber howitzers is designed to utilize setback, but low rotational forces cannot be relied upon. The centrifugal lock pin is therefore omitted, and a pull pin holds the rotor in the unarmed position. A pull pin is also inserted through the plunger of the standard powder-train time fuze so that a jolt in the right direction during handling would not set off the primer and time train. This precaution is necessary because setback is utilized to start the time action, and, since the plunger must function with low setback, requiring a delicate support which would not withstand handling, provision for safety must be made in the form of a pull pin.

Smooth-bore mortar fuzes utilize setback for arming and have pull pins as well. In addition to setback, they employ the "bore rider" principle of arming, wherein the setback pin releases another pin which is pushed out against the inside of the mortar tube, and which then "rides the bore" and is ejected at the muzzle, thus allowing a slider to line up the detonator or initiating some other arming feature.

11. Design Formulas.

Fuze and booster designs are based on tactical requirements. However, wherever possible the design features of similar available fuzes are taken as models. The design is somewhat predetermined by limitations on weight, diameter, and contour, especially in designing an artillery fuze or booster to fit with the standard American Point Fuze System, as described in Art. 19 of this chapter. But, since fuzes may have moving parts in order to accomplish arming by some method required for a

certain tactical purpose, it is desirable to check such arming by calculations. The strength of the fuze parts may also require checking or analysis. Some of the fundamental formulas for this purpose will be listed here. The nomenclature listed in Art. 5 of Chapter 5 will be followed where possible.

Speed of Rotation. The speed of rotation at the muzzle or at any point along the bore may be found from equation 1 in Art. 5. The speed of rotation just outside the muzzle, where it is required that fuzes arm, may be considered to be substantially that at the muzzle. In order to determine whether sufficient centrifugal force exists to cause centrifugal pins, arming balls, sliders, etc., to move out, the speed of rotation must first be known, allowance being made for a factor of safety. Usually the speed at which the moving elements move outwards is calculated and compared with the speed known to exist from equation 1.

Centrifugal Force. The centrifugal force acting on any part of a rotating fuze (or projectile, for that matter) can be calculated from the fundamental formula

$$CF = R(RPM)^2 \frac{\omega}{g} \quad (15)$$

where CF = centrifugal force.

R = distance from center of rotation to center of gravity of part considered.

RPM = speed of rotation.

ω/g = mass of part considered.

If CF is expressed in pounds, R in inches, RPM in revolutions per minute, and ω in grains, the formula becomes

$$CF = \frac{R(RPM)^2}{246 \times 10^6} \quad (16)$$

Since most moving parts in fuzes which are subject to movement because of centrifugal force are restrained by springs and can move away from the center of rotation only a limited amount, we can substitute the force exerted by the restraining spring under these conditions for CF in equation 16 and calculate the RPM required to overcome the spring resistance. Or the CF can be calculated by using the maximum RPM , and the spring may be designed to be less than the result so obtained, so that the part will definitely move out before the maximum RPM is obtained.

Creep Force. After emergence from the muzzle the projectile and its fuze are retarded, and all parts not directly acted upon by the air are

subjected to forward-acting forces proportional to their weight. Thus, all parts inside a fuze, particularly inertia-type plungers and firing pins, try to move forward owing to their inertia because the component in which they are contained, such as the fuze housing, is being slowly decelerated. This phenomenon is called CREEP, and the creep force is usually a maximum at the point where the projectile is first subjected to air resistance, just outside the muzzle.

To calculate the creep force on any part of a fuze weighing ω grains, the following formula is applicable for zero yaw:

$$C = \frac{C_R D^2 V^2 \omega}{gW} \quad (17)$$

where D is the caliber in inches, V is muzzle velocity in feet per second, W is total weight of fuzed projectile in pounds, all as defined in Art. 5, Chapter 5. C_R is a resistance coefficient, dependent upon the shell contour and velocity. For fuze-design work it is usually taken at its maximum value, assuming that impact sensitivity is not affected by the creep spring, at about 13.5×10^{-5} . The principal use of this formula is in the design of creep springs or resistance washers which must be strong enough to keep firing pins away from sensitive primers and detonators until impact occurs. These springs are usually not sufficiently strong to stop the firing pin from being jarred against the primer if subjected to a severe drop in a certain direction during handling or shipment, so that safety pull pins are usually added which pass through the firing pin or inertia plunger, and are withdrawn just before firing. Shear pins are also inserted for additional safety. A factor of safety may be applied with formula 17.

Nose Air Resistance. Certain fuzes of the superquick variety, which have firing pins in the nose of the fuze, have a nose closure over the firing pin in the form of a thin closing disc from 0.005 to 0.020 in. thick. Other fuzes may have nose strikers which after arming are ready to push a firing pin in against a primer at impact. For such designs it is desirable to calculate the pressure on these discs or strikers due to air pressure on the nose of the fuze as it moves through the air. The flat-plate air-resistance formula may be expressed as

$$p_1 = \frac{13V^2}{10^6} \quad (18)$$

where V is the muzzle velocity in feet per second, usually used because it is the maximum velocity, and p_1 is the unit pressure on the nose element being considered, in pounds per square inch.

This formula is applicable for velocities between 1500 and 2500 ft./sec., and a factor of safety of 2 is usually allowed to be sure that air pressure will not cause the nose striker to be pushed in or the nose closure to be broken.

Spring Design. Almost every fuze has one or more springs in it which restrain centrifugal elements, cause sliders to move into the armed position, eject safety pins, resist setback and centrifugal pins, etc.; the usual spring formulas, for free length, load, deflection, stress, etc., may be found in any standard handbook.

Fuze Stresses. The actual stresses in the various parts of the fuze body may be difficult to compute. The forces at impact, especially with resistant targets, may be many times (say 3000 to 2,500,000 times) the weight of the fuze. Actual firing is about the only way to prove designs.

Setback Force. When a projectile and fuze are accelerated in the gun, forces exist in the projectile and fuze due to the reactions of their masses; these reaction forces are called **SETBACK FORCES**. They are really acceleration forces. Of course, there is no better way to check a design as being adequate to withstand these forces than to fire the projectile and fuze in the actual weapon under the worst conditions expected. Nevertheless, it is very desirable that some test method be employed to simulate setback conditions in the gun, and for this purpose the **DROP TEST** is satisfactory.

In this test the projectile or fuze is dropped base down from a certain height on a hard surface so that on impact a negative acceleration equal to the positive acceleration in the gun is obtained. From the fundamental equation of force equals mass times acceleration, we can write the acceleration in the gun as

$$\alpha = \text{Acceleration} = \frac{\text{Force}}{\text{Mass}} = \frac{Pa}{W/g} = \frac{Pag}{W} \quad (19)$$

where α is the acceleration in feet per second per second; P , a , W are maximum pressure in pounds per square inch, area of bore in square inches, and total weight of projectile in pounds. This equation may be written as

$$\text{Force per grain} = \frac{Pa}{7000W} \quad (20)$$

when the force is expressed in pounds, and it is used as a measure of setback. Thus, a 155-mm. projectile weighing 95 lb., fired at a maxi-

imum pressure of 30,000 pounds per square inch (area of bore is 29.75 sq. in.), is subject to an acceleration force of

$$\alpha = \frac{32.2 \times 30,000 \times 29.75}{95} = 270,000 \text{ ft./sec.}^2$$

or, the setback in pounds per grain is

$$\text{Force per grain} = \frac{30,000 \times 29.75}{7000 \times 95} = 1.2 \text{ lb./grain}$$

The setback force is sometimes expressed as "so many g 's," or as Pa/W in pounds per pound. In this example it would be 8400 g .

In order to analyze the relationship between the actual setback acceleration and that of the drop test, consider that the projectile and fuze are dropped base down from a height of H ft., attaining a velocity V_1 ft./sec. just before impact during its fall in t sec. Let f be the distance in inches in which the projectile is decelerated from V_1 to 0 ft./sec. It is this distance f which must be made small in the drop-test equipment by using hard-steel plates on a suitable concrete base, in order to simulate gun setback. We may write

$$V_1 = \sqrt{2gH} \quad (21)$$

$$t = \frac{V_1}{-\alpha} \quad (22)$$

where $-\alpha$ is the deceleration in the time t , corresponding to the actual acceleration α in the gun. Also, by making the assumption that the average velocity during deceleration is $V_1/2$, we may write

$$t = \frac{f}{V_1/2} = \frac{2f}{V_1} \quad (23)$$

Equating 22 and 23,

$$\frac{2f}{V_1} = \frac{-V_1}{\alpha}$$

or

$$f = \frac{-V_1^2}{2\alpha} \quad (24)$$

Substituting in 24 the value of α from 19, and V_1 from 21,

$$f = \frac{WV_1^2}{2gPa} = \frac{WH}{Pa} \quad (25)$$

For the 155-mm. projectile weighing 95 lb. and dropped from a height of 50 ft. (a practical height for a drop tower),

$$f = \frac{95 \times 50 \times 12}{30,000 \times 29.75} = 0.064 \text{ in.}$$

Therefore, the 95-lb. projectile must come to rest while traveling the short distance of 0.064 in. in order to give it a negative deceleration equal to the positive acceleration it receives in the gun. Actually, we are not simulating gun conditions because the average velocity during deceleration is not half the maximum velocity, and the time during deceleration is not equal to the time of acceleration in the gun. The time corresponding to $f = 0.064$ in. is

$$t = \frac{2f}{V_1} = \frac{2 \times 0.064 \text{ in.}}{12\sqrt{2} \times 32.2 \times 50} = 0.0002 \text{ sec.}$$

whereas the actual time in the gun is 0.0033 sec., much longer. The actual velocity-distance curve during the deceleration would have to approximate the velocity-distance curve of the projectile in the gun, to consider that the drop test actually simulates gun firing.

Assuming, however, that the drop-test machine designed on this basis is still useful in simulating setback, it is necessary to vary the height (for a given distance of travel during deceleration) in order to simulate different setbacks. Thus, for $f = 0.064$ in., a 37-mm. projectile weighing 1.23 lb. and fired at 30,000 lb./sq. in. maximum pressure (bore area 1.67 sq. in.) would require dropping (for equivalent setback) from a height of

$$H = \frac{Paf}{W} = \frac{30,000 \times 1.67 \times 0.064}{1.23 \times 12} = 260 \text{ ft.}$$

which is impractical. The other alternative is to make the impact more sudden (f as near 0 as possible); in fact, the value of f required to simulate setback of this 37-mm. projectile (for a height of 50 ft.) is

$$f = \frac{WH}{Pa} = \frac{1.23 \times 50 \times 12}{30,000 \times 1.67} = 0.015 \text{ in.}$$

which is so small as to be almost impossible of attainment. The Picatinny Arsenal drop-test machine, Fig. 53, has a value of $f = 0.03$ and therefore simulates 75-mm. and larger projectile firing but is not suitable for smaller calibers.

The value of the drop test is to check projectile loading, questionable fuze or shell designs, fuze arming (actuated by setback alone), fuze loading, or any element of the design to ascertain whether it is properly designed to withstand setback forces.



FIG. 53. Drop-test tower.

12. Fuze-Design Tests.

After the fuze designer has completed a design to meet certain requirements, he must test preliminary samples to check the various features of the design. These tests may be part of the general requirements for all satisfactory fuzes, or they may be some special tests for a particular fuze which must meet special requirements. Some of the general tests usually conducted to check the design are discussed here.

Detonator Safety Test. Fuzes containing out-of-line elements must be tested, usually statically, to determine that the detonation will not

"jump the gap," that is, to insure that, if a sensitive initiating element ahead of or in the out-of-line feature were to detonate spontaneously, the out-of-line feature definitely interrupts the detonation, preventing its transmission to the booster and shell bursting charge. It has been advisable to conduct these tests with loaded shell, since it has been found that the presence of the shell is a factor.

Explosive-Train Continuity. Armed fuzes are usually tested statically to determine whether each element in the train detonates properly and a high-order booster detonation results. This test also should be conducted in a live shell to check adequacy of the booster itself. In this way any detrimental barriers in the explosive train can be discovered and corrected. The trouble can be narrowed down to one particular detrimental feature by making part of the explosive train inert in order to discover the particular spot or element which needs correction.

Arming Test. Fuzes containing centrifugal elements should be spun in a suitable machine to test for satisfactory arming, that is, determination of the minimum speed of rotation at which centrifugal elements move out. This insures their arming at minimum speeds of rotation expected in the weapon. Setback elements can also be tested outside the gun by dropping fuzes in a drop-test machine from a height of drop corresponding to minimum setback in the weapon.

Jolt and Jumble Tests. For years it has been customary to test fuzes and boosters of all types of ammunition in standard jolt and jumble machines. The purpose of such tests is to ascertain whether the fuzes and boosters are so designed that no parts or subassemblies become loose, that staked, crimped and threaded parts have been assembled properly, that explosive elements like primers and detonators do not become loose or spill their charges, that shear pins do not shear, that safety pins are adequate, etc. The test is admittedly more severe than conditions are expected to be in actual handling and transportation, but it is an excellent test of a new design, and a factor of safety between the test conditions and the actual conditions is essential when dealing with explosive elements.

The jolt test consists of assembling the item into the end of a pivoted arm which under cam action falls by gravity through 4 in. on a heavy bed plate, giving a considerable jar to the item. It is usually tested for 1750 jolts in each of three positions, vertically up, down, and horizontal. The jolt machine is shown in Fig. 54.

The jumble test consists of placing the item in a standard steel fixture which completely encloses the item, then putting the fixture inside a rectangular hardwood maple box, which is rotated about its diagonal corners. The fixture containing the item rolls inside the box, receiving

bumps at random. The box rotates at 35 r.p.m., and the test usually consists of 3600 revolutions. The jumble machine is shown in Fig. 55.

Handling and Transportation Tests. In order to test ammunition components in their actual packing containers to determine not only whether

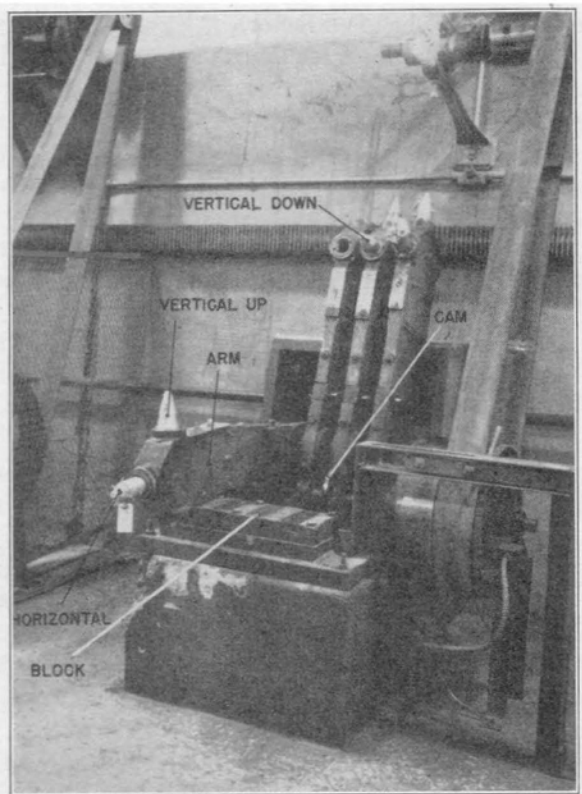

FIG. 54. Jolt machine.

the containers are satisfactory but also the protection that the packing gives to its contents, handling and transportation tests are conducted. It often happens that there is no apparent damage to a container or to the outside of an element being tested in the container but that some internal damage to a fuze or booster results. Details of handling and transportation tests will be discussed in Chapter 13.

Actual Firing Tests. The old adage "the proof of the pudding is in the eating" was never more true than when applied to ammunition. Preliminary fuze and booster samples should be fired in live shell to test arming, high-order detonation, and general acceptability. Fuzes that

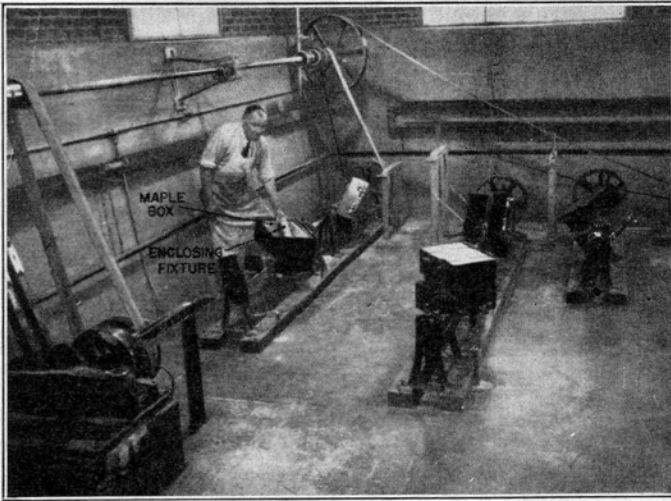

FIG. 55. Jumble machine.

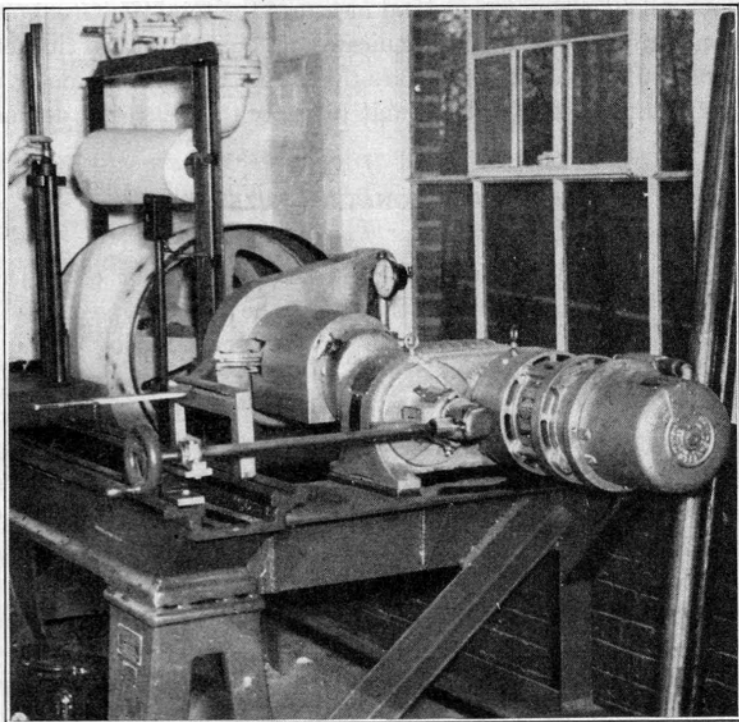

FIG. 56. Rotating drum chronograph.

have safety elements should be fired to ascertain whether they are safe in the unarmed position. The adequacy of out-of-line elements must also be determined by tests. Of course, some fuzes are not designed to withstand this test. Firing for recovery gives valuable information when it is important that the action of a certain element be determined, and it is this firing for recovery that gives the designer indispensable information.

Testing Delay Element. The delays in fuzes vary from 0.01 to 0.25 sec. and are obtained by inserting small black-powder pellets in the explosive train after the primer and before the detonator. In order to test for static delay times, an electrical timing device may be used, or a rotating drum chronograph, shown in Fig. 56. The electrical timing device starts by the closing of an electrical circuit when the primer is fired, and stops by the breaking of the circuit when the detonator fires. The chronograph consists of a drum covered with paper rotating at a known speed. When the primer is fired its flash makes a mark on the paper, and when the detonator fires another mark is made, the time between the two being calculated from the distance between the marks and the known speed of rotation. Of course, either method measures the total time from primer to detonator functioning, which indicates not only the actual time of the delay unit but also the time it takes the primer to ignite the delay unit, and the time it takes the delay unit to ignite the relay and detonator.

BASE-DETONATING FUZES

13. Uses.

Base-detonating fuzes are located in the base or rear of projectiles and initiate the detonation from the rear. The fastest type of base fuze action is the so-called non-delay, a few milliseconds slower than the superquick action, and obtained by means of an inertia-type plunger built in the body of the fuze. Therefore, a base fuze cannot be used where surface burst is required. Neither can a base fuze be used for time fire because it does not lend itself to easy setting, base-fuzed projectiles being shipped fuzed and sealed. But base fuzes do have one ideal application, and that is in armor-piercing projectiles, where point fuzes are unsuitable and where definite delay action is required to function the projectile after the plate has been negotiated.

Another application for base fuzes is in HEAT projectiles where it is desired to initiate the detonation from the rear for correct operation according to the shaped-charge principle, and also where point fuzes might be in the way for proper jet penetration (see Chapter 2).

The 37-mm. antitank gun fires a light projectile (M63) which is intended to burst on graze impact as well as give a little delay action on direct targets, and a small base fuze has long been common for that purpose.

Base fuzes are therefore used for the following purposes:

(a) For the 37-mm. lightweight high-explosive shell (M38 and M58 fuzes).

(b) For medium-caliber armor-piercing shell, 57, 75, and 90 mm. (M72, M66, and M68 fuzes with tracer).

(c) For medium-caliber HEAT projectiles, 75 and 105 mm. (M62 fuze).

(d) For large-caliber armor-piercing shell, 155 mm. and above (old Mk X and present M60).

14. Fuzes for 37-mm. HE Shell (M38, M58).

The M38 fuze was first developed as a simple base fuze for firing a lightweight high-explosive shell. A somewhat larger fuze for the same purpose, known as the M58, was developed later and is used today. It is shown in Fig. 57. It will be discussed in detail so as to make clear the fundamentals of arming and the fuze explosive train. There are three main subassemblies, most of the metal parts being of brass: the fuze body (C), the detonator holder (D), and the booster (B). All three assemble into a small compact base fuze about 2 in. long and weighing $\frac{1}{3}$ lb., which screws flush into the base of the shell. Inside the body is a heavy steel firing pin (E), which on setback merely exerts a force on the base of body. Also inside the body and around the firing pin is a plunger (F) held in place by a brass ring (G) around a shoulder on the firing pin against the force of a spring (H). On setback the inertia of this plunger causes the ring to be expanded and move back with the

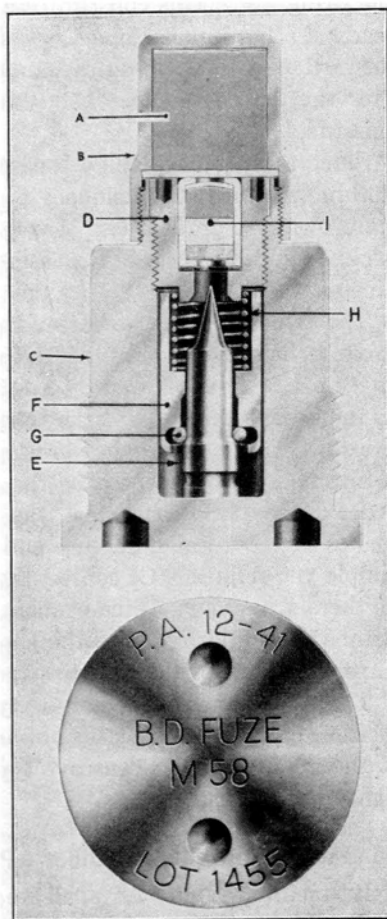

FIG. 57. M58 artillery fuze.

plunger, with the help of the spring, until the resistance ring snaps into a rear groove in the firing pin, in effect locking the plunger assembly to the firing pin. This constitutes arming of this fuze. The fuze is then ready to fire upon impact. Firing is accomplished by the moving forward of the firing-pin assembly, which compresses the spring and fires the detonator (*I*). The resistance ring provides drop safety for this fuze.

Since arming takes place on setback in the gun, all through flight nothing restrains the tendency of the firing-pin assembly to move forward owing to gradual loss of velocity except the spring, which is called a CREEP SPRING because it resists the tendency of the moving parts to creep forward.

The explosive train consists of the three-part detonator with a priming mixture near the firing pin, lead azide as a middle charge, and tetryl as a final charge followed by a tetryl booster. It is easy for the tetryl in the detonator to "get" the tetryl in the booster (*A*) because of their proximity and because they are separated by only two thin discs. Such a fuze is a good one because the simplicity of its design insures high-order detonation of the shell, the presence of only a few moving parts makes it easy to manufacture and positive in action, and the arming is simple yet definite. Of course, the fuze does not have detonator safety as there are no out-of-line elements and spontaneous functioning of the detonator would detonate the shell. This fuze will function on graze impact because of the comparatively light creep spring.

The M58 fuze is of the non-delay type having the inertia plunger type of firing pin—the fastest type of action obtainable with a base fuze. It is also about the most sensitive type of base fuze possible because of the light creep spring.

15. Fuzes for Medium-Caliber AP Shell (M72, M66, M68).

By medium-caliber AP shell we mean 57-, 75-, and 90-mm. and 3-in. shell, fitted with a small compact base fuze of steel, having a tracer, short delay, and integral booster. These fuzes are called M72, M66, and M68, respectively. They operate on the same principle, the only difference being that the small M72 fuze for the 57-mm. shell has no booster, the booster being replaced by a booster pellet loaded in the base of the shell so that the fuze is screwed up flush in contact with the pellet. All three fuzes have a delay of about 0.02 sec. to insure detonation after penetration.

The M66 fuze, considered typical for this class, is shown in Fig. 58. The heavy plunger-type firing pin (*H*) pushes against the base of the fuze (*I*) on setback and is prevented from moving forward until impact

by a resistance washer (G). No arming takes place in the gun or just outside of it, and the fuze is really armed all the time, except that the resistance ring is carefully calibrated so that it restrains the firing pin until severe plate impact is encountered. If the shell hits soft soil or any target not offering sufficient resistance to shear the ring, a dud will result.

On impact, the firing pin rides forward, shearing the ring, and firing a small fuze-type primer (F) which flashes through to a small black-powder delay element (E) in a holder (D). This flashes to a two-part detonator (C) of lead azide and tetryl, which in turn detonates the tetryl booster (A) and (B). This fuze protrudes from the rear of the shell and is boattailed and fitted with a tracer (J) which is ignited by the powder gases and functions independently of the balance of the fuze.

The M68 fuze is similar to the M66 except it is a little larger to accommodate the 90-mm. shell. The M72 is a little smaller to accommodate the 57-mm. shell.

16. Fuzes for Medium-Caliber HEAT Projectiles (M62).

When the shaped-charge principle was first adopted to armor-piercing projectiles, a base fuze was decided upon to initiate the detonation from the rear in the hope that such a fuze would be fast enough to give detonation in front of the plate, with the liner at the proper standoff distance. As this action would be difficult to accomplish with a high-velocity projectile, and as these projectiles were to be fired against tanks at comparatively short ranges, say under 2000 yd. (even shorter for good accuracy), it was decided to try them in the lower-velocity howitzers of 75- and 105-mm. caliber. There resulted the 75-mm. M66 and the 105-mm. M67 HEAT projectiles, both having the M62 base fuze shown in Fig. 59.

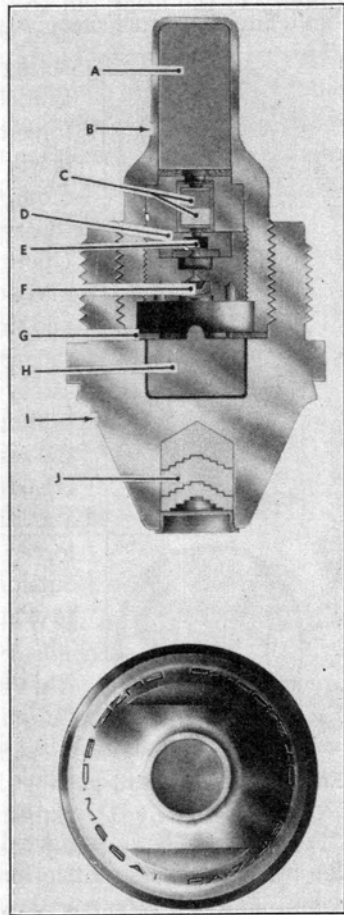

FIG. 58. M66 artillery fuze.

This fuze is really made up of two parts, the head assembly (*M*) with a so-called Semple-type¹ firing pin, and the body assembly (*C*) containing the explosive and arming elements and booster. The center of gravity of the firing pin (*K*) is so disposed with respect to the fulcrum

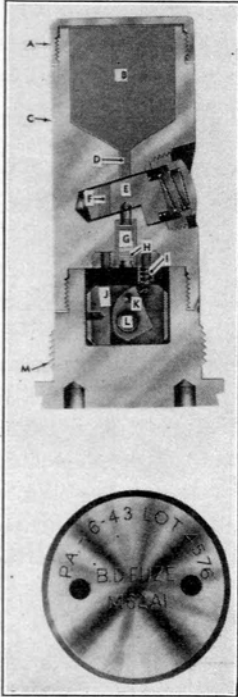

FIG. 59. M62A1 artillery fuze.

that when both setback and centrifugal forces are acting the firing pin stays in the unarmed position, but that outside the bore, when setback force has ceased and centrifugal force continues, it will line itself up with the detonator. Furthermore, the firing pin is prevented from rotating to the armed position by two centrifugal pins (*L*). Upon impact the firing-pin plunger assembly moves forward, compresses the creep spring (*I*), and fires the detonator (*G*) and (*H*), which is of the usual three-part stab-action type. Detonator safety is obtained by means of a slider (*E*) containing a tetra lead charge (*F*) out of line with the rest of the explosive train. The slider is inclined at such an angle with respect to the fuze axis that under both setback and centrifugal forces it remains in the unarmed position, but outside the gun centrifugal force alone causes it to compress its spring and line up its charge. The booster (*B*) is integral with the fuze body, and its pellet is in direct contact with the balance of the train (*D*) and held in place by a cap (*A*).

A shorter fuze would be better because it would initiate the detonation as far to the rear of the HEAT liner as possible, but in order to have detonator safety with an out-of-line element the fuze had to be a little longer. Here is another example of design compromise—if safety is required, something else must be sacrificed.

17. Fuzes for Large-Caliber AP Projectiles (Mk X, M60).

For armor-piercing projectiles of 155 mm. to 16 in., a base fuze of heavier construction than the M66 type is needed. The fundamental requirements are the same, namely, strength to withstand plate penetration, delay action, detonator safety, and positive arming. However, the range of such projectiles, which are primarily of the seacoast type,

¹ Named after Mr. John Semple, who first developed the firing pins applying this arming principle.

is so great that a tracer burning for a few seconds would be worthless, so these fuzes do not have tracers.

The Mk X BD fuze which is used on AP projectiles over 155 mm. and the M60 fuze with the 155-mm. AP projectile arm in exactly the same way. The two fuzes have some minor contour variations and different physical properties of the body. The M60 fuze, which weighs 9 lb. and is $4\frac{1}{4}$ in. long, is shown in Fig. 60. It employs a Semple-type arming pin (*M*) which rotates about a pivot and aligns itself exactly the same as that in the M62 fuze by means of centrifugal pins (*N*). The detonator

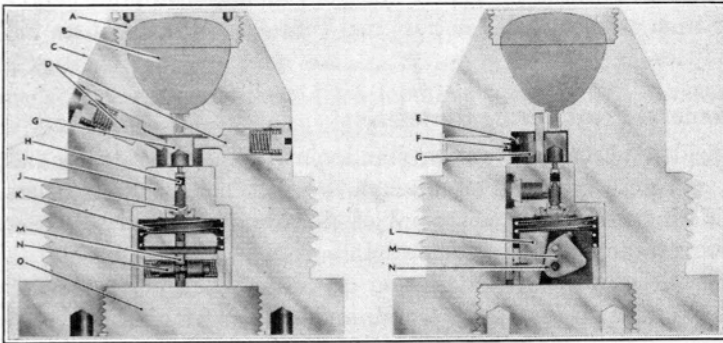

FIG. 60. M60 artillery fuze.

is contained in a rotor which is prevented from rotation to the armed position by two centrifugal pins (*D*), one inclined at an angle so that it cannot move out until setback force has ceased. When these pins move out, the rotor (*G*) rotates to move the detonator into position because the rotor center of gravity tries to move as far as possible from the center of rotation. Then, when impact occurs, the firing-pin plunger assembly (*L*) moves forward in its housing (*I*) to compress the creep spring (*K*), fires a primer (*J*), which flashes to the black-powder delay element (*H*), thence to a small pick-up of lead azide which transmits the impulse to a two-part flash-initiated detonator, and finally to the booster (*B*). The peculiar elliptical shape of the booster is supposed to concentrate and reinforce the waves resulting from the detonation of the booster. The rotor is locked in the armed position by a pin (*E*), and the fuze is closed at the ends by plugs (*A*) and (*O*).

POINT-DETONATING FUZES

18. Uses.

Point-detonating fuzes, located in the nose of the shell, are used with high-explosive and chemical shell. All time fuzes are point fuzes because

accessibility is required for setting them, which would be impossible with a base fuze, located and sealed in the base of a shell and shipped with it. Another reason for having all time fuzes of the point variety is that nose fuzes are easily assembled to and disassembled from shell, and interchangeability between time fuzes and other point fuzes is a necessity.

When surface burst on impact by superquick action is required a point fuze must be used because the firing pin initiates functioning before penetration is obtained. The inertia action of a plunger which requires the fuze and shell to decelerate before functioning would be unsatisfactory. Then, of course, it is desirable to combine superquick action with either time or short delay action, and these combination fuzes must be point fuzes.

19. General Point Fuzing Systems.

Considered from the design standpoint, point fuzes really fall into three categories, or systems, though they are not usually so classified. Considering fuzes from this point of view, however, will help keep the numerous types straight in one's mind.

We will start with a description of the so-called point fuze system, which pertains to fuzes for 75-mm. ammunition and larger, and which was evolved between World Wars I and II for the purpose of eliminating the then heterogeneous collection of point fuzes, so that all point fuzes might be interchangeable, both physically and ballistically. This system meant that an artilleryman could fire a given size and weight projectile with either a superquick or a delay or a time fuze, and apply the same range table. All fuzes were therefore required to screw into the same booster, having a 2 in.-diameter thread to fit all projectiles, and to have the same weight (1.4 lb. without booster) and the same contour (streamlined) so that they could be screwed interchangeably into any shell without changing the projectile as-fired weight or the external ballistics. All time fuzes use the same fuze setter. By this system, a field gun could fire a high-explosive projectile with a superquick fuze and then immediately, without adjustment for weight or ballistics of the fuze, fire a high-explosive projectile with a delay fuze or a time fuze. Not only are all our fuzes today part of the point fuze system, but new fuzes are designed to fit into it. The contribution of the system as regards interchangeable parts and minimizing the number of types, thus facilitating mass production, has been inestimable, with corresponding benefits on the battlefield.

The system has some disadvantages, which are recognized: smaller shell are probably overfuzed and overboosted, in order that larger shell may be properly fuzed and boosted; the fuzes are more com-

plicated and take more materials than the unsatisfactory World War I types; some limitations are placed on the designer of new types because the size, weight, and contour are pre-established. It goes without saying that these disadvantages are more than outweighed by the advantages, and the system now applies to all fuzes for projectiles from 75-mm. to 240-mm.

For certain larger shell where maximum range is essential, it is desired to streamline the front end of the projectile by means of a long false ogive. Putting the standard fuze in such large shell would result in a comparatively blunt nose. A superquick fuze modified for this purpose is called a "Mod" fuze. These modified fuzes may be called a second fuzing system, and such projectiles as 155-mm. and 8-in. have been so modified. The construction of such modified fuzes will be discussed in the detailed description of typical fuzes.

Only small-caliber artillery fuzes of sizes 20, 37, 40, and 57 mm. remain to be discussed. No standardization has been effected in fuzes for these sizes, and little is possible because of weight and contour limitations. Whereas a 40- and 57-mm. high-explosive projectile could conceivably take the same fuze, such a fuze would not be possible in a 37-mm. projectile, and definitely not in a projectile as small as 20 mm. These small-caliber fuzes, then, constitute the third system, there being more than a dozen fuzes for service ammunition alone in this group.

Summarizing, we have three fuzing systems:

(a) Fuzes for 20-, 37-, 40-, and 57-mm. projectiles, there being a different fuze for each type of projectile of each caliber.

(b) The standard point fuze system for 75-, 76-, 90-, 105-, 155-, and 240-mm. and 3-, 4.5-, 4.7-, and 8-in. projectiles.

(c) Fuzes for false-ogive projectiles.

20. Small-Caliber Point Fuzes.

Fuzes for 20-mm. Projectiles (Mk I, M75). This caliber was added to American ammunition by adoption from the British in 1941. The original Mk I shell contained a combination high-explosive-incendiary mixture to set airplane gasoline tanks on fire and was fitted with the No. 253 Mk I/A fuze, the /A designation indicating use in an aircraft mounted gun. This Mk I fuze together with the Mk II and III varieties are used with older 20-mm. shell, and a new fuze, the M75, with newer shell. All operate on the same principle, are made of brass, and are streamlined to fit the shell contour.

The M75 fuze is shown in Fig. 61. It is characterized by the absence of a firing pin, a unique feature for a fuze. The solid nose is intended to effect just the right delay for functioning inside a plane, preferably in-

side the gas tank. The fuze requirement is that it shall not function on a 0.012-in. steel plate but must function on a 0.083-in. plate. There are no moving parts, no detonator safety, and no arming. On impact the crushing of the nose combined with the inertia of the primer disc sets off the primer, which then functions the azide detonator and the tetryl booster, all self-contained in the fuze, which is a little more than an inch long and weighs only 350 grains.

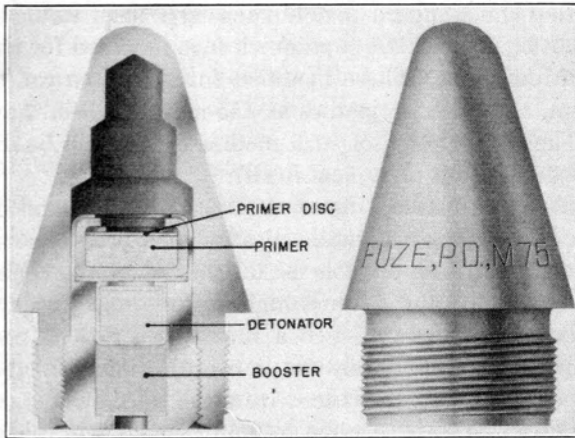

FIG. 61. M75 artillery fuze.

Fuzes for 37-mm. Projectiles (M56, M74). The standard point fuze for 37-mm. high-explosive shell is the M56 fuze, which is of the super-quick-supersensitive type. It is therefore suitable in antiaircraft work, where detonation on extremely light targets, such as an aircraft wing, is required. The fuze will function from impact with a tiny twig of a tree or bush, and reports have been received that the fuze has functioned in heavy rain by hitting a rain drop. The fuze is made from aluminum, is 2.2 in. long, and weighs 0.17 lb.

The fuze is shown in Fig. 62. It consists of three main subassemblies: nose (*B*) containing the supersensitive element, head (*F*) containing the detonator, and body (*L*) containing the slider (*J*) and booster (*M*). During setback the firing pin (*C*) and (*D*) presses down in the grooves of the half-blocks (*E*), preventing their outward movement, the same being accomplished outside the bore when centrifugal force alone is acting. The firing pin is then "free floating," and nothing but the thin closing disc (*A*) protects it. The slider is located below the detonator (*H*) in a holder (*G*), the out-of-line element being a tetryl lead (*K*), and functions similarly to the slider in the M62 BD fuze. Below the slider is the

booster pellet (*M*) held into the body by a cup which screws in flush with the fuze base. The explosive train of this fuze has three tetryl leads between the detonator and the booster: the top lead to provide continuity because of the distance between the detonator and the slider; the lead in the slider itself; and the lead under the slider to the booster. Sometimes practice ammunition is more important than service ammunition, particularly at the start of a war when millions of troops are being trained. This was the situation in 1941 when there arose an insistent demand for a 37-mm. practice round for fire from sub-caliber weapons. The M74 fuze, Fig. 63, was developed for use with the black-powder-loaded M92 practice shell, and the detonator of the fuze ignites the shell filler without a booster. The fuze consists of a die-cast body (*B*), rotor housing (*C*), rotor (*G*), and closing plug (*H*). The Simple-type rotor contains two lead plugs (*F*) and detonator (*E*). Setback causes the setback pin (*D*) to move back and holds the rotor unarmed by friction, after which the rotor aligns the detonator with the floating firing pin.

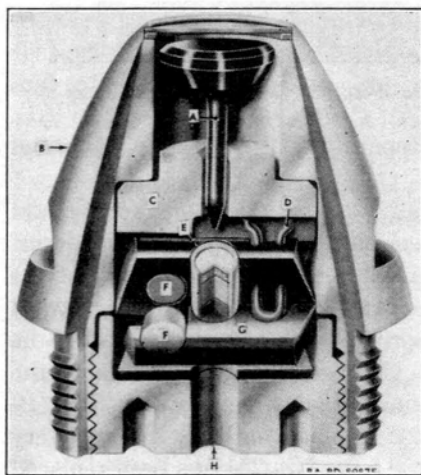

FIG. 63. M74 artillery fuze.

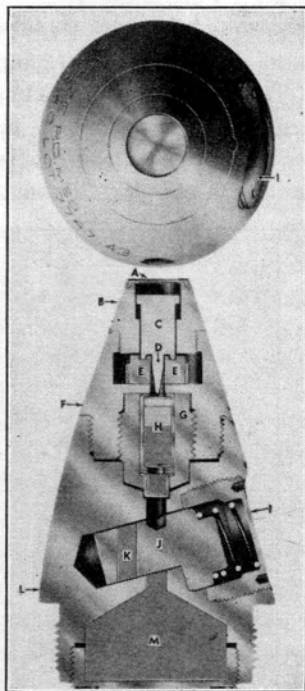

FIG. 62. M56 artillery fuze.

FIG. 62. M56 artillery fuze.

Fuzes for 40-mm. Projectiles.

1. DA No. 251, Mk I/L/ fuze is another caliber of gun and ammunition adopted in 1941 from the British, who in turn adopted it from the Bofors Company of Sweden. The original fuze was the British DA, No. 251, Mk I/L/, where DA stands for direct action, corresponding to our super-quick action, and the /L/ means use on land (as against the 20-mm. ammunition originally designed for the aircraft gun). This No. 251 is a complicated fuze, even

according to American safety standards; it is shown in Fig. 64, and its functioning will be summarized.

The fuze consists of three main sections: the head (A) containing the firing-pin striker (B); the middle portion (I) containing a delayed arming feature for the firing pin, and a primer (J); the lower portion (M) containing a two-part detonator, together with a shutter (N) (centrifugal

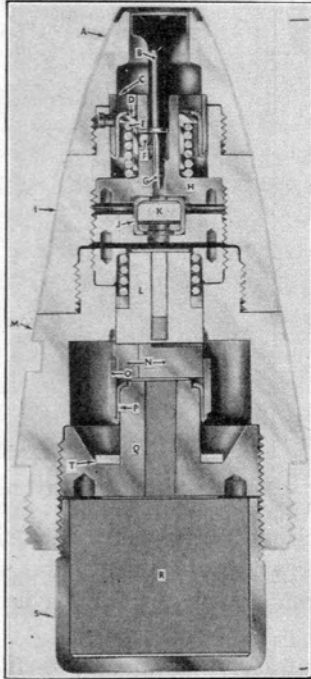

FIG. 64. No. 251 artillery fuze.

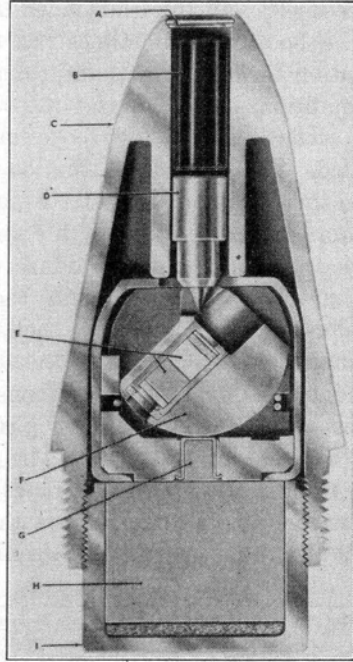

FIG. 65. M64A1 artillery fuze.

blocks) and a long tetryl lead. The separate booster cup (S) is screwed into the bottom of the fuze.

The firing-pin arming feature is based on the action of a ferrule and stirrup in conjunction with three steel balls (F) under the shoulder of the firing pin. Upon setback the ferrule and stirrup move back; after setback is over, the stirrup is deformed so as to permit it to move forward to release the arming sleeve (D) by spring action (E), thus allowing the balls to release the firing pin (G). Centrifugal force also allows the shutter to move out so that the spring-actuated detonator holder (L) moves back, bringing the detonator near the booster lead. Being a very complicated device for a single-purpose fuze, No. 251 has been replaced by other fuzes.

2. The M64A1 fuze was designed to replace the No. 251, because of its comparatively simple construction. It is shown in Fig. 65. It employs die castings for the body (*C*), rotor housing, and booster cup (*I*). Arming consists of aligning the detonator (*E*) in the rotor (*F*) with the firing pin (*D*), tetryl lead (*G*), and booster (*H*). The rotor is prevented from rotating by two centrifugal lockpins held in position by a spring, and delayed arming is accomplished by designing the pins so that between 10,000 and 20,000 r.p.m. are required to move them out against the resistance of the spring. The rotor center of gravity tries to move to a maximum distance from the center of rotation, thus aligning the detonator. The firing pin has a shoulder that rests on the sides of the rotor slot, and it has a plastic striker (*B*) over it under the nose closing disc (*A*).

The M64A1 was replaced by the Navy Mk 27 fuze.

3. The M71 fuze. Still another type of fuze, known as the M71, was developed for 40-mm. ammunition, based on another arming principle and also quite simple in construction. The Semple-type rotor in the form of a cylinder is employed, cut out so as to align the detonator in the rotor by centrifugal force. The rotor is restrained from arming until the unique setback pin moves back on setback. The firing pin is in contact with the rotor, the rotor being contained in a rotor housing. The tetryl lead and booster are self-contained. This is a small, compact fuze of simple construction, yet detonator safe. It has been used as an alternative to the Navy Mk 27 fuze described below, both of which have displaced the No. 251 and the M64.

4. The Mk 27 is a Navy-design fuze considered standard for 40-mm. ammunition. It is similar to the M71, except for operating on a different arming principle. It is shown in Fig. 66. Even though it has two arming features, it is simple in construction. The body is suitable for die casting and contains a firing-pin assembly (*K*) and (*I*) and a detonator assembly (*D*). The booster assembly (*A*) and (*B*) screws into the bottom of the body to hold the detonator assembly in place. The firing-pin arming feature consists of two centrifugal pins (*G*) under the pin shoulder, which move out, the pin and its forward plastic striker (*K*) being held forward by creep action until impact. The detonator arming feature consists of a rotor (*C*) with an out-of-line detonator prevented from rotating to the armed position until two other centrifugal pins (*E*) have moved out, after which the wafer-type rotor (*C*) rotates to the armed position.

The long strikers in these 40-mm. fuzes result from the general construction and contour requirements. Sensitivity is effected by the choice of light materials for the firing-pin assembly. The M64, M71, and Mk 27 fuzes are all simple-construction, single-purpose, detonator-safe, superquick fuzes with bodies and other parts adaptable to mass produc-

tion. These fuzes are used primarily in antiaircraft work, both by the Army and the Navy, the self-destructing feature being in the tracer end of the shell as described in Chapter 3, rather than a time fuze being employed.

Fuzes for 57-mm. Projectiles. The 37-mm. M56 fuze has been modified by increasing the length of the nose and firing pin for adaptability to

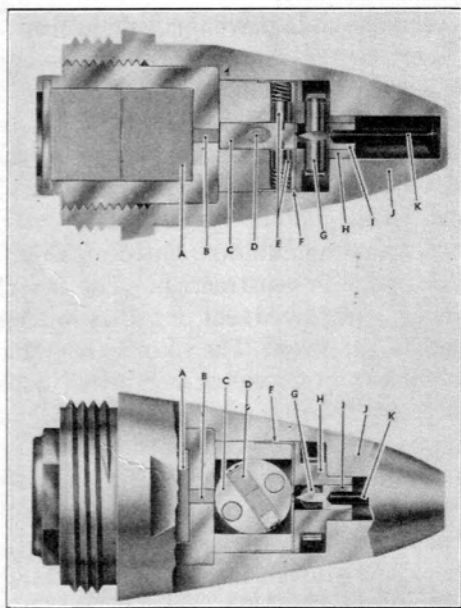

FIG. 66. Mk 27 artillery fuze.

57-mm. high-explosive shell. The safety half-blocks are located between the nose and head assemblies just above the three-part detonator, and the slider and other features of the M56 fuze are retained.

STANDARD INTERCHANGEABLE POINT FUZES

21. General.

We are now ready to discuss that series of fuzes designed for all caliber projectiles from 75-mm. up, with certain variations to suit particular tactical requirements. Bear in mind that the object is to have all point fuzes, regardless of their type, weigh exactly the same, have the same contour, fit into the same booster, and have the combination fuze and booster fit into all projectiles. Small-caliber point fuzes have boosters built into the body of the fuze, the fuze and booster being part of the

same design, manufactured together, and shipped as a unit ready for assembly into the projectile at the complete round plant. Furthermore, small-caliber point fuzes are assembled to rounds ready to fire and are not assembled to projectiles in the field.

The standard line of fuzes, however, may be assembled into rounds either at the complete round plant or in the field. Ammunition up to and including 105-mm. is shipped as complete rounds already fuzed, but larger-caliber projectiles are shipped unfuzed and assembled in the field. But regardless of whether the projectiles are fuzed in the assembly plant or in the field, fuzes and boosters may be interchanged. The fuzes weigh 1.4 lb. and the boosters about 0.8 lb. It so happens that ammunition under 155-mm. is used in larger quantities than larger calibers, and such rounds are available already fuzed with time fuzes, or combination superquick and delay fuzes, etc., so that changing fuzes in the field may not be so important. But it can be done, and of course the major benefit from the standard system is not so much this interchangeable feature as applied to any one projectile as the fact that rounds with various fuzes may be fired in any order desired, without correction for differences in fuze and booster weights, thus simplifying range-table requirements.

22. Impact Fuzes.

The M57 Fuze. Let us start with the simplest standard point fuze, the M57, which is a single-purpose superquick fuze. This fuze is used in high-explosive projectiles fired from aircraft and for many chemical and smoke projectiles. High-explosive rounds fired from field weapons are usually fuzed with double-purpose fuzes in order to obtain more versatile action right at the point of firing.

The M57 fuze, shown in Fig. 67, obviously is simple in construction yet has an interrupted explosive train. The body (C) is of steel, the ogive (D) of aluminum, and the front end superquick element (A) of brass. The interrupter (B) is placed at such an angle that, while both

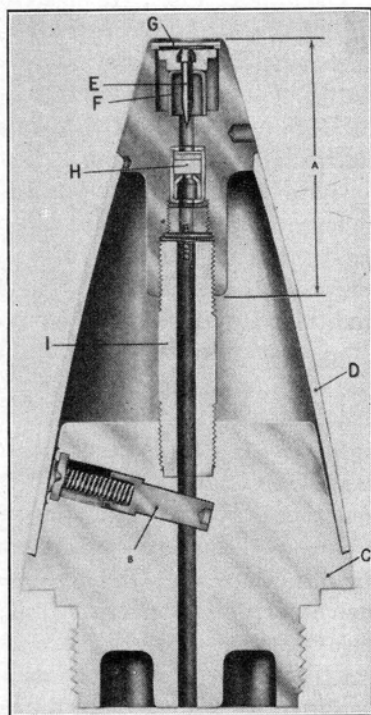

FIG. 67. M57 artillery fuze.

setback and centrifugal forces are acting in the gun, it does not move out, but outside the gun, where centrifugal force acts alone, it does move out, opening up the central passage. The firing pin (*E*) is supported by a copper crusher cup (*F*), and the front of the fuze is sealed with a closing disc (*G*). On impact, either nose down or graze action, the pin is driven into the two-part detonator (*H*) of primer mixture and azide, and the flash as well as the small pieces of metal from the detonator travel down the center tube (*I*) to the detonator of the booster with which the fuze is used.

The M48A2 Fuze. If we were to add a delay element (*L*) in the base (*H*) of the M57 fuze, leaving the nose superquick element (*C*, *D*, *E*) unchanged but changing the interrupter so that it contains a selective setting screw accessible through a hole in the ogive (*F*), we would have the M48 fuze, the most widely used and best known of all artillery fuzes. This combination superquick and delay fuze, and the action upon firing for both settings, are shown in Fig. 68.

The arming of the interrupter (*J*) is the same as in the M57 fuze except that the diameter of the recess containing the setting sleeve (*I*) is larger than the diameter of the cavity containing the interrupter itself, and these two diameters are not concentric. The result of this construction is that the interrupter is allowed to move out against the spring (*K*) the same as in the M57 fuze when the M48 fuze is set superquick but is not allowed to move out when set delay. An additional arming feature is the two centrifugal pins (*Q*) in the inertia-type delay unit, which are also at an angle, and which move out owing to centrifugal forces. A small lock (*P*) flies out as the result of rotation to keep these pins in the locked position. The delay unit has a fixed-position firing pin (*M*) against which the primer (*N*) of the unit impinges as the delay unit moves forward upon impact. The primer flashes to a small black-powder delay element (*O*) of 0.15 sec. (formerly 0.05 sec.) contained in an obturated element, which then flashes to a relay (*R*) and thence over to the center of the fuze down to the booster.

Now, when the fuze is set superquick, the interrupter moves out, and on impact the front-end detonator (*E*) flashes through the tube (*G*) to the booster. Of course, the delay unit moves forward, but before it can function detonation takes place. If the superquick element fails, the fuze will function on delay action anyway. If set delay, the interrupter does not move out, and on impact the superquick element flashes through to the interrupter and is blocked at that point, the delay unit functioning in the normal manner.

The purpose of such a delay unit in a point fuze is to get penetration into resistant objects, such as medium soil, wood-frame buildings, etc.,

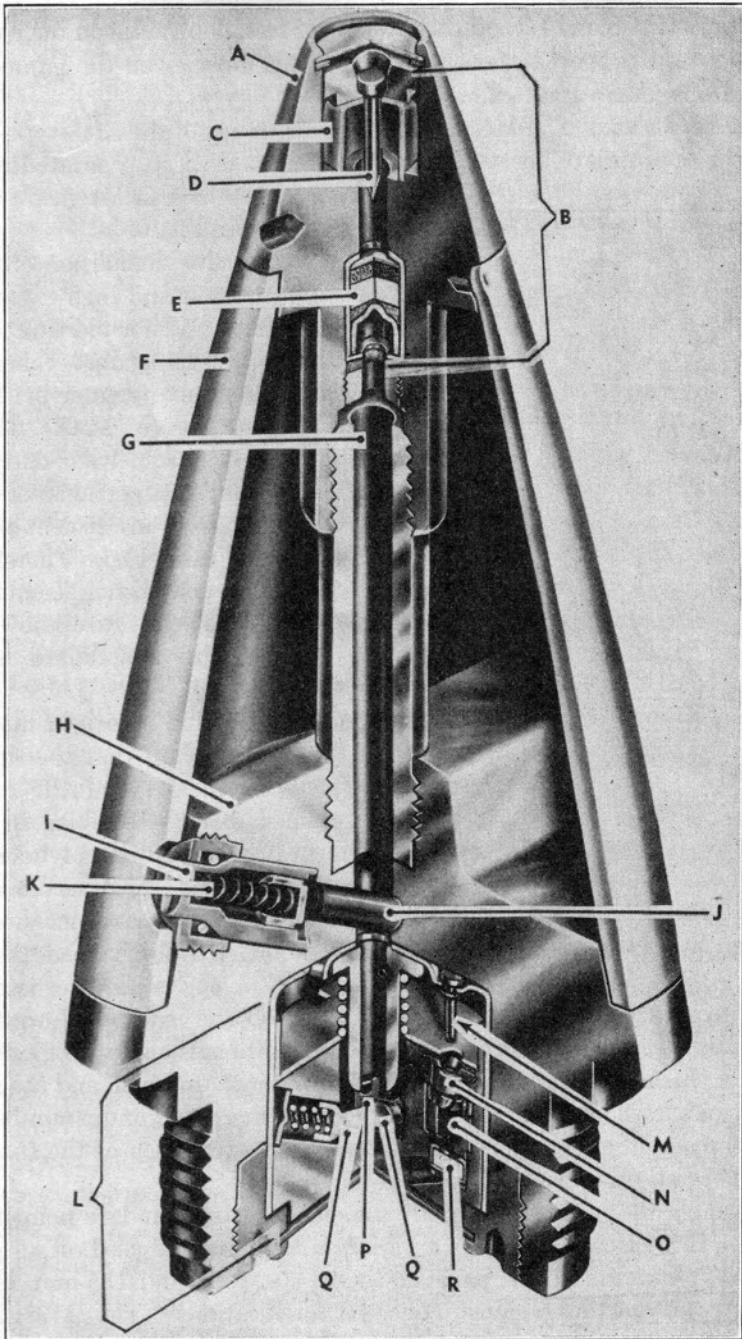

FIG. 68. M48A2 artillery fuze.
153

or to get burst 8 or 10 ft. off the ground (or less, depending on the length of delay) on ricochet action against personnel, either on the ground or dug into trenches and foxholes.

The M51 Fuze. The M51-type fuze is composed of the M48-type fuze and the appropriate booster (see Art. 29); it is used on separate loaded rounds, being assembled in the field. The assembly is shown in Fig. 69.



FIG. 69. M51A3 artillery fuze.

with this fuze, consisting of the M21A4 booster shortened so that the fuze threads bear directly on the shell threads instead of on the booster threads. The booster is first screwed into the shell, and the fuze is screwed down on top of the booster. By having a maximum number of fuze threads in engagement with the shell, the tendency of the fuze to be dislocated on impact is kept to a minimum.

Although the fuze is not strictly a member of the standard point fuze system, it is discussed here as a variation, and may be used on all projectiles 75-mm. and over, particularly on 90-, 105-, and 155-mm. high-explosive projectiles against concrete fortifications. The M78 fuze played a most important part in reducing German concrete fortifications along the Rhine and elsewhere.

The M78 Fuze. For demolition of concrete, both penetration and high-explosive effect are required. Armor-piercing shot are somewhat effective against concrete, especially since they have greater penetration than high-explosive shell. High-explosive shell are also somewhat effective since the blast removes portions of the concrete, but, because of insufficient penetration, their effect is limited. Therefore, in order to obtain penetration combined with high-explosive effect, a fuze known as the M78 is used with a standard high-explosive shell.

This concrete-piercing fuze is a modification of the M48 type, in that the super-quick element is omitted and the delay element retained, being assembled in the base of the heavy chromium-molybdenum steel body heat-treated to a hardness of C30 minimum. The fuze has 2-in. threads and weighs about 2.1 lb. instead of the standard 1.4 lb. A special booster is used

23. Time Fuzes.

Types and Uses. TIME FUZES are used to obtain burst in the air before impact. Time fire is required for these tactical purposes:

1. Antiaircraft fire, where the time of projectile flight is about 25 sec. or less.

2. Fire against ground targets, particularly where troops are deployed in trenches and foxholes and burst overhead is effective, also requiring a setting of 25 sec. or less.

3. High burst ranging, wherein fire of long-range projectiles is adjusted by means of spotting the air burst of projectiles fitted with time fuzes, before firing projectiles fitted with impact fuzes; this application requires time fuzes up to 70 sec. setting.

The two general methods of obtaining the time delay are either by means of a powder train or by a mechanical clockwork mechanism. The maximum time obtainable with a POWDER-TRAIN FUZE to fit the standard contour system was formerly 25 sec., and that is the maximum time of the standard present-day powder-train fuzes. Experimental work indicates that a much longer time can be obtained with development powders loaded into the standard 25-sec. ring, even as much as 60 sec. For the present, however, we must consider powder-train fuzes limited to about 25 sec. Another limitation of powder-train fuzes is their erratic performance at high altitudes under varying conditions of temperature, pressure, and humidity, especially as compared to the excellent performance of a mechanical mechanism under those conditions.

The clockwork time mechanism has the disadvantage that it is complicated and delicate, but times up to 70 sec. are easily obtained. MECHANICAL TIME FUZES have been limited to single-purpose fuzes because the mechanism occupies the central axis of the fuze, thus precluding a front-end superquick element requiring a clear central channel. Experimental fuzes have been developed that do combine a mechanical clockwork time mechanism and a front-end superquick element.

We are now able to understand why powder time fuzes have certain applications, and mechanical time fuzes other applications. The powder fuze would be unsuitable for antiaircraft work, even though the burning time were satisfactory, because of the necessity for corrections for changes in atmospheric conditions which affect burning time. It is suitable for time fire against ground personnel, and, since it can be combined with a superquick element, an excellent double-purpose fuze results. The single-purpose mechanical time fuze is well adapted for anti-aircraft work, 30 sec. being ample time. For high burst ranging, where longer time is required, and where the fuze reaches considerable altitude,

the mechanical time fuze is also ideal, as single-purpose action is quite suitable.

The tactical and design requirements of time fuzes are therefore summarized as:

1. A fuze for single-purpose antiaircraft time fire, the M43 mechanical time fuze, maximum setting 30 sec.

2. A combination superquick and time fuze for antipersonnel fire, the M54 superquick and powder time fuze, maximum setting 25 sec.

3. A single-purpose fuze for high burst ranging, the M67 mechanical time fuze, maximum setting 70 sec.

The M54 Fuze. This fuze may also be considered a derivative of the M57 fuze, a time element having been added to the body (*R*) of the fuze, and other elements, such as the superquick element (*A, B, C, E*) and the interrupter (*S*), being the same. Because the body of the fuze is solid in order to house the two time train rings (*K, P*) necessary to obtain 25-sec. delay, and because an inertia plunger element (*F*) is built into the body to set off the delay column, the body parts are made from aluminum instead of steel in order to maintain the weight of the standard line of fuzes. The rear of the fuze contains a black-powder magazine charge (*T*) to

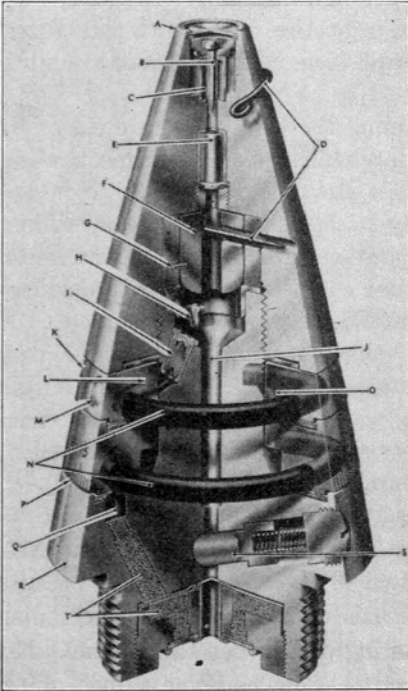

FIG. 70. M54 artillery fuze.

provide continuity of the explosive train between the end of the delay train and the detonator of the booster. The same boosters are used with this fuze as with the M57 and M48 fuzes.

The M54 fuze is shown in Fig. 70. The superquick element and interrupter function exactly as in the M57 fuze. This means that should the fuze fail to function on time setting, or be set safe so that the time element does not function, the fuze will function superquick on impact.

The body of the fuze contains a plunger (*F*) through which both a safety pull pin (*D*) and a small shear wire (*G*) pass so that the plunger cannot accidentally move and set off the time train primer (*I*) during

handling and shipping. With the safety pull pin withdrawn, the plunger moves rearward on setback by shearing the shear wire and pushes the primer striker (*H*) against a primer such as the Mk V commercial type, which flashes to a pellet, thus igniting the upper time train. This powder burns through to the lower ring pellet (*O*), through the lower train to a body pellet (*Q*), and thence down the body lead charge to the magazine.

The upper ring is fixed in position by a set screw in the body; the lower ring is graduated and is movable. The rings are held in compression by a tension washer and separated by a felt washer that serves to confine the flame and gases and to facilitate movement without disturbing the thin onionskin-paper washers shellacked over both powder trains. The rings are vented to the exterior by a hole (*M*) in each, closed by a lead foil disc. The movable ring is graduated from 1 to 25 by 0.2 divisions, and is marked "S" or "safe" opposite the body index line. When so set the position of the pellets is such that the rings do not burn through. The minimum setting corresponds to 0.4 sec., because safety discs are placed over the ignition end of the graduated ring so that when set for less than 0.4 the body pellet cannot be ignited, thus preventing detonation too near the gun.

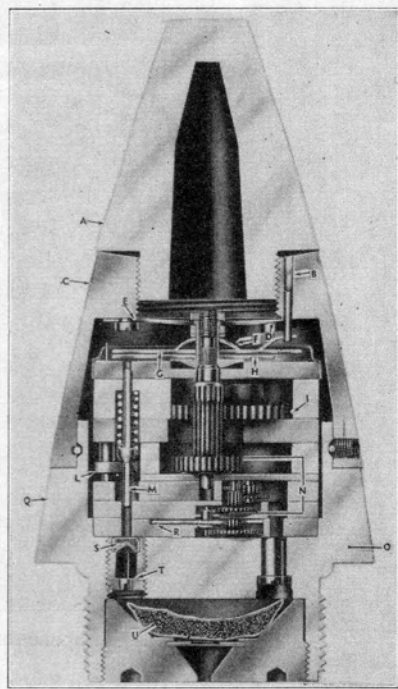

FIG. 71. M43A4 artillery fuze.

Next to the M48, the M54 is probably the most popular fuze for general use against ground targets.

The M43A4 Fuze. To fulfill the requirement for a single-purpose mechanical time fuze for antiaircraft work, the M43 fuze was developed, which has the standard contour and weight and is used with the same booster as the other standard fuzes. Inasmuch as the mechanism is quite complicated, it will only be summarized here. It is illustrated in Figs. 71 and 72.

The fuze consists of an aluminum head (*A*), fastened to a brass middle section (*C*) that houses the clockwork mechanism. The aluminum base

(*Q*) is fixed and is graduated from 1 to 30 sec. by 0.2-sec. intervals, the middle and top portions being rotated together to set the fuze. Timing is regulated by the angular distance a timing disc (*G*) must turn before the firing arm (*J*) releases.

It requires both setback and rotation to arm and drive the fuze. There are three safety elements: a small hammer (*D*) moves back on setback

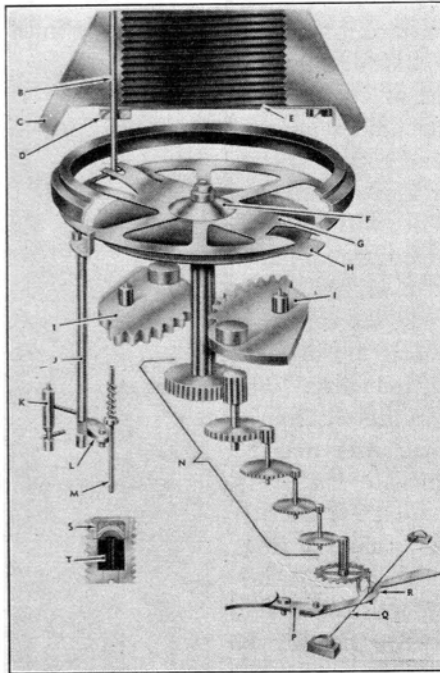

FIG. 72. Components of M43A4 artillery fuze.

to flatten a lug on the timing disc (*G*) before *G* can start rotation; the striker assembly (*J*, *M*) just ahead of the primer (*S*) is locked until a setback pin (*K*) releases it; and a safety lock (*P*) on the escapement (*R*) is released by centrifugal force. The mechanism is driven by two weighted gear segments (*I*) which try to rotate to a position where their centers of gravity are farthest from their pivots, and in so doing apply torque to the main stem. This stem is connected through a gear train (*N*) to the escapement, which controls the speed of the entire mechanism. When the notch in the timing disc (*G*) has rotated the predetermined distance it releases the firing mechanism (*J*), which is spring-actuated, thus firing the primer, which flashes to the black-powder pellet (*T*) under it and thence to the magazine (*U*) and the booster.

The fuze cannot be set to dangerously short times because a safety disc is under the timing disc with a segment under the notch, so that, if the notch is too near the firing mechanism, the disc will have to rotate at least the width of the segment. The minimum setting time has varied from 0.6 to 1.7 sec. for different models, being now about 0.6 sec. The fuze can be set safe by moving the graduated portion to the "S" setting. It is used on the 3-in., 90-mm., and 105-mm. antiaircraft ammunition, set by an automatic fuze setter as part of the fire-control equipment.

The M67 Fuze. The requirement for single-purpose time fuze with settings up to 75 sec. for high burst ranging is met by the M67 fuze, which is identical to the M43 fuze except for time, being of the standard size, weight, and contour. A clockwork mechanism, constructed and operating on the same principles as that for the M43 fuze, is employed, except that the centrifugal gear segments are spring-driven. An additional feature is the presence of a safety pull pin through a setback pin which controls the escapement lever. Minimum setting is 1.5 sec.

This fuze is used with 4.5-in., 155-mm., 8-in., and 240-mm. ammunition for either high burst ranging or in place of a powder time fuze for time fire, and with the usual booster for these calibers.

The M55 Fuze. This fuze is really a combination of the M54 fuze and the M21 booster, both being shipped to the field as a unit. It is used for time fire against personnel in 155-mm. ammunition and as an alternative to the M67 for 8-in. and 240-mm. ammunition.

The M61 Fuze. The development of the 120-mm. (4.7-in.) antiaircraft gun necessitated a new fuze with a much longer nose than the M43 in order to streamline the fuze with the long 50-lb. projectile and obtain maximum range. The M43 fuze was modified by adding an extended conical nose, resulting in a fuze weighing about 0.2 lb. more than the standard. Although developed particularly for this caliber and type of ammunition, and not strictly a member of the standard fuze family, it is mentioned here as a modification of the M43. The setting time, safety, and functioning features are the same. It is shown in Fig. 73.

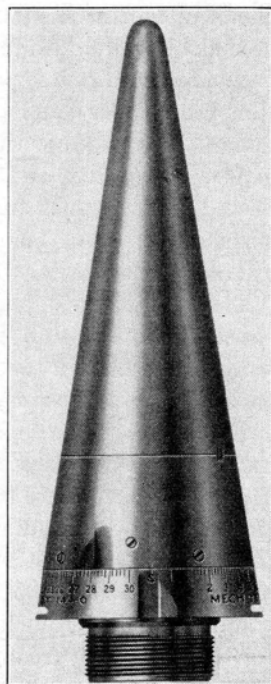

FIG. 73. M61 artillery fuze.

MORTAR FUZES

24. Types and Uses.

Most mortar fuzes are of the point-detonating type, and they differ from artillery fuzes in that centrifugal force is usually not available for arming as most mortars are of the smooth-bore variety without rifling. The 60- and 81-mm. light trench mortars are smooth-bore, the 4.2-in. chemical mortar is rifled, and the 105- and 155-mm. heavy mortars are smooth-bore. Ammunition for the 60- and 81-mm. trench mortars is divided into two types requiring different fuze action: a lightweight shell (about 7 lb.), and a heavier shell of the cylindrical type, as discussed under "Mortar Projectiles." The lightweight tear-drop shell has a high explosive capacity of 15-20%, and, since little penetration can be expected, a superquick fuze is required to scatter the fragments near the surface, the effect being primarily fragmentation instead of blast or mining. The heavy cylindrical shell is made in the 81-mm. size only. A short delay fuze is required for the heavy shell because the explosive capacity is about 40%, ideal for mining or blast effect. Because of these considerations, and the fact that a double-purpose fuze is more complicated, single-purpose mortar fuzes are customary.

For smoke shell a superquick fuze is obviously needed. For illuminating shell, a time fuze is required. For antipersonnel work in World War II, where mortars are used in jungle warfare and elsewhere, a combination time and superquick fuze, similar to the M54 fuze, is necessary in order to get air burst over the heads of personnel deployed in trenches and foxholes. The 105- and 155-mm. heavy smooth-bore mortars require combination superquick and delay fuzes the same as artillery projectiles, for, in fact, they really are heavy artillery projectiles. Our line of mortar fuzes is now quite complete and includes almost as many types as exist for artillery projectiles, except mechanical time fuzes.

FUZES FOR 60- AND 81-MM. PROJECTILES

25. Fuzes for High-Explosive Projectiles.

The M52 Fuze. This is a single-purpose superquick fuze for either 60- or 81-mm. trench mortar ammunition; it is shown in Fig. 74. It is $3\frac{1}{2}$ in. long, weighs 0.45 lb., and screws into a 1.5-in. diameter hole in shell. The head (*D*), body (*L*), and booster cup (*O*) may be made of aluminum, or all plastics, or either aluminum or plastics, but with a brass head (*D*) to add weight for stability in flight.

The head contains a striker (*A*) to which the firing pin (*C*) is attached, the spring (*B*) under the striker being compressed at impact. The firing

pin is held in the head assembly by a pin (*E*). The detonator (*I*) is held out of line by a slider (*F*) which is held in the unarmed position by a long safety bore-riding pin (*G*), which in turn is held in the unarmed position by a setback pin (*N*) through which a safety pull pin (*M*) passes. This safety pin is pulled immediately before the round is dropped in the mortar; on setback the setback pin then may move back, allowing the safety bore-riding pin to move out by spring action until it touches the bore, which it "rides" until the projectile reaches the muzzle, where it

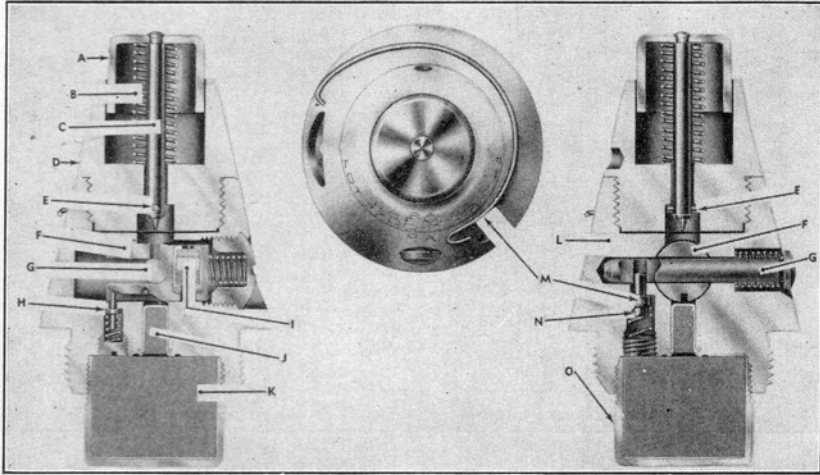

FIG. 74. M52 mortar fuze.

is totally ejected. The slider then moves over to the armed position by spring action and is there locked by the slider lock pin (*H*), thus completing arming, including an out-of-line feature, without the utilization of centrifugal force. Upon impact the firing pin fires the detonator, which in turn fires a booster lead (*J*) and the booster (*K*).

The M53 Fuze. This is a single-purpose delay (0.10 sec.) fuze, primarily for the 81-mm. trench mortar where the heavy high-explosive projectile can be expected to give some penetration. It is shown in Fig. 75. It is not made of plastics because the fuze must withstand impact and still function on delay. It has the same weight, length, and threads as the M52 fuze, to which it is a companion.

The striker is somewhat different, a sheer wire being broken on impact to allow the firing pin to hit a primer. The flash initiates an obturated delay element, which then ignites a relay, all these elements being above the slider. The slider contains a two-part detonator, but otherwise the

slider, safety bore-riding pin, setback pin, and slider lock pin, booster lead, and booster are identical in the M53 and the M52 fuzes.

The M77 Fuze. When we were forced into jungle warfare combined with island warfare by the Japanese, the need arose for time fire from mortars. Artillery weapons for time fire could not be made available at the beginning of an assault, and air burst was required against not only personnel deployed in foxholes and slit trenches, but also against

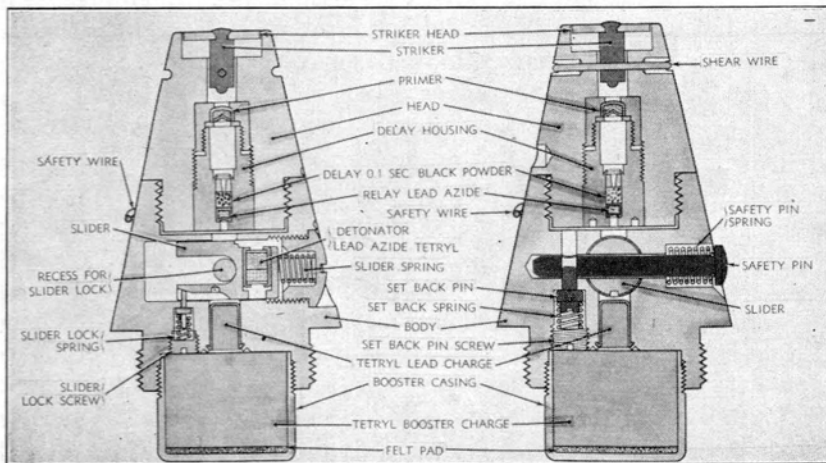

FIG. 75. M53 mortar fuze.

personnel hiding in volcanic rock crevices and caves. In order to make available on short notice a combination time and superquick mortar fuze for the heavy, cylindrical M56 shell for the 81-mm. mortar, fuzes were designed utilizing the superquick elements of the M52 mortar fuze and the time train ring elements of the artillery M54 fuze. This combination, redesigned so that the M52 fuze slider and the M54 fuze rings fit in and around the same body, is now called the M77 fuze. It is shown in Fig. 76.

It is 5.0 in. long, has 1.5-in. threads, and has two safety pull pins (*C*, *J*), one for the time inertia element (*B*) that impacts the firing pin and primer (*E*) to initiate time action as in the M54 fuze, and the other through the body to restrain the setback pin (*I*) as in the M52 fuze. The superquick element arms by the bore rider pin (*H*), and the fuze detonates on impact unless it is still in the air at the expiration of the time for which set.

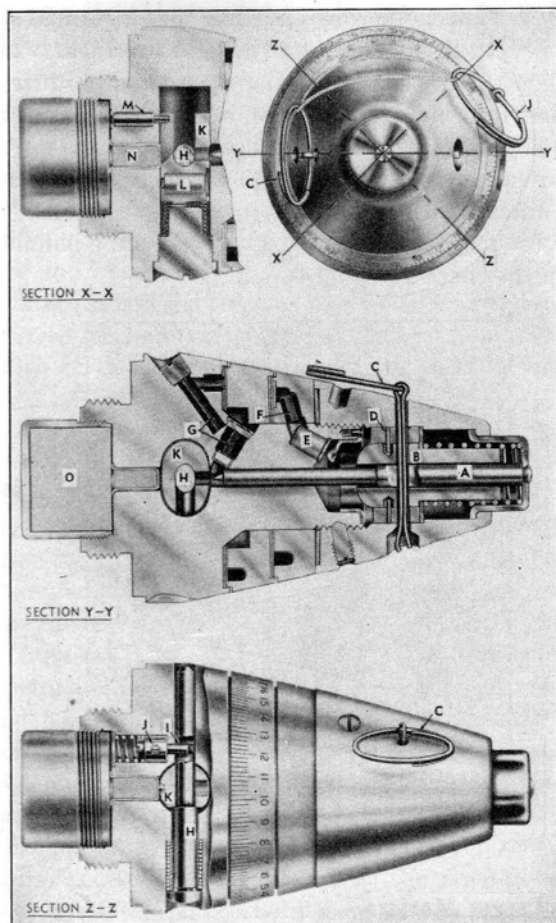

FIG. 76. M77 mortar fuze.

26. Fuzes for Illuminating Projectiles.

The M65A1 Fuze. This is a single-purpose, fixed-time powder train fuze for use with the 60-mm. illuminating shell. It is shown in Fig. 77 and is extremely simple in construction and operation.

A safety pull pin (A) through the plunger-type firing pin (C) in the head (D) is withdrawn just before firing. On impact, the plunger shears a small wire (B), impacts a primer (E), and ignites a single powder train ring (F, G, H), which burns for 14 sec. A body pellet (I) in the body (J) burns through at the end of the train to a magazine charge (K) held in with a closing disc (L). The fuze parts may be made from bar stock or die castings of aluminum, the ring being brass.

The M84 Fuze. This is the corresponding fuze for the 81-mm. illuminating projectile, but it can be set for times between 0 and 25 sec. The fuze is more like the M54 artillery fuze than the M65 fuze, in that it has two powder rings, the top one being initiated by an inertia element through which a pull safety wire passes. On setback the inertia element shears a weak shear pin, built into the fuze for additional safety, and then fires a primer which provides obturation. The time train burns through to a base magazine charge that functions the illuminating shell as described in the chapters on pyrotechnics.

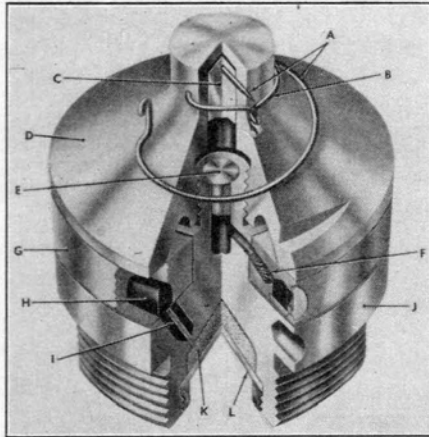

FIG. 77. M65A1 mortar fuze.

HEAVIER MORTAR FUZES

27. Fuzes for Larger Mortars.

The 4.2-in. Chemical Mortar Fuze, M2 or M3. This is a single-purpose superquick fuze for use with either chemical or high-explosive shell, and it is unique in that most of the arming is accomplished by centrifugal force. A safety pull pin through the firing pin is withdrawn just before firing. A movable sleeve shears a pin on setback, the sleeve moves back, and two balls under the firing-pin striker are then released by centrifugal force. The firing-pin striker is pushed out by a spring up to a stop pin, and the firing-pin point is thus removed from a recess in the slider, the slider moving out by centrifugal force, lining up the out-of-line detonator. A pin in the slider moves out by centrifugal force into a hole, locking the slider in position. The balance of the explosive train consists of a tetryl lead and a long booster, similar to a burster, in order that it may work with both chemical and high-explosive projectiles.

Larger Smooth-Bore Mortar Fuzes. The M4 rocket fuze has been used as a fuze for larger smooth-bore mortar ammunition, the low setback of these mortars being comparable to that in the 4.5-in. rocket. Various combination superquick and delay fuzes are being developed for these mortars, employing either powder or mechanical time delayed arming. The requirements for such a fuze are heavy metal parts to withstand nose impact against resistant targets and still function delay, delayed arming, combination superquick and delay functioning at the target, and proper shape and weight for these larger mortar shell. The usual bore-riding pin is not adaptable to the larger-caliber weapons, and either powder train or mechanical delayed arming is employed to eliminate the possibility of the premature functioning of the shell close to the mortar.

ARTILLERY BOOSTERS

28. General.

Since the sensitive initiating elements in fuzes must be kept to a minimum size consistent with good functioning for safety reasons, and since the bursting charges of shell are comparatively insensitive—which is indeed fortunate—we need some in-between component to pick up the impulse from the fuze and transmit it to the bursting charge, so that high-order detonation will result. Such components are called BOOSTERS, and they act as amplifiers and transmitters of the detonating wave. The common intermediate explosive is tetryl, because it is easily initiated by detonators and bursting charges are easily initiated by it, and because it pellets easily.

Small-caliber point fuzes and base fuzes have boosters built integral with fuzes, the boosters being initiated by the same detonator that is functioned by the firing pin, or by a relay charge if a delay element is present. The boosters for the standard fuzes (75-mm. and over) are separate units, although they may or may not be shipped assembled to fuzes. For rounds having cartridge cases and shipped ready to fire, the fuzes and boosters are assembled in the loading plant; but for separate-loaded ammunition (4.5-in. and larger) the fuze and booster are assembled together in the loading plant, given one number for the combination, and assembled to the projectiles in the field.

Because these separate boosters may be initiated by the impulse from a relay (as in the M48 fuze when set delay), or by flash from black powder (as in the M43 and M54 fuzes), or by spit from a primer several inches away (as in the M57 fuze, and the M48 and M54 fuzes when set superquick), they usually contain detonators themselves in order to insure positive action. Furthermore, it is the practice in American fuze

design to incorporate arming features in these boosters in order to supplement the arming features of the fuzes in which they are used. Therefore, we may call these boosters **AUXILIARY FUZES**. All these separate artillery boosters have the same internal threads in order to receive any of the standard fuzes, and they have the same external threads in order to screw into the standard shell booster cavities, these diameters being 1.7 and 2 in., respectively.

The bodies of these separate boosters are usually made of brass and the booster cups of aluminum, and they are designed to have a standard weight of about 0.8 lb. Booster cups are usually made from aluminum or zinc, either machined from bar stock or die cast. It has been found that cups made from stampings are not very satisfactory since they do not give good fragmentation and tend to inhibit the booster action.

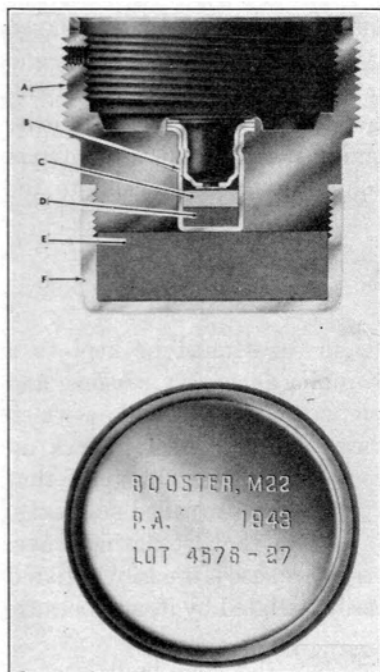

FIG. 78. M22 artillery booster.

detonator safe, and because only on large-caliber chemical shell is a booster needed in addition to the burster. This booster is also considered an emergency booster which could be made in large quantities at a minimum of cost if the more complicated boosters are not available in sufficient quantity. The M22 booster consists of a two-part detonator (*B, C, D*) of azide and tetryl, no primer mixture being required because it is initiated by flame action of a relay or by a detonator or by a black-powder magazine charge ahead of it (in a fuze) in the train, and a booster element (*E, F*) directly below the detonator consisting of one tetryl pellet contained in a booster cup. The body (*A*) is made of brass.

The M20A1 Booster. This booster does have a rotor containing an out-of-line detonator feature, and it may be considered an auxiliary fuze because it incorporates arming features. Before the rotor (*H*) can move

29. Description of Standard Boosters.

The M22 Booster. This is the simplest booster; it is shown in Fig. 78. It is used only in chemical shell of larger caliber, principally the 105-mm., for the reason that it has no arming feature and is therefore not

to the armed position, as will be seen by reference to Fig. 79, a centrifugal pin must move out, and this cannot happen until a setback pin (*P*) first moves back, which latter pin is kept back in the armed position by a little slack or play in the hole so that the sidewise thrust due to centrifugal force catches the setback pin under a small shoulder. The setback pin therefore acts also as a centrifugal lock pin in that it holds the centrifugal pin in the armed position. During setback the rotor (*H*) does not move into the armed position because of friction of the flat rotor

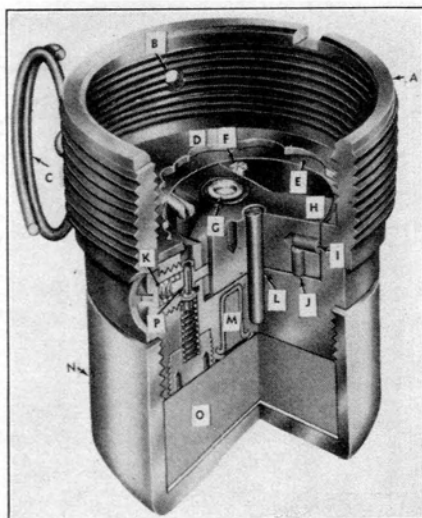

FIG. 79. M21A4 artillery booster.

surface pressing against the body (*A*), but after setback, centrifugal force arms the rotor by causing it to rotate about the pin (*L*) so that it is locked by pins (*I*, *J*).

The explosive train consists of a two-part detonator (*G*) flashing to the booster lead (*M*) and booster (*O*) in a cup (*N*). This booster may be used in 75-mm., 76-mm., 3-in., 90-mm., and 105-mm. ammunition with either the M48, M54, or M43 fuzes for either field or antiaircraft work, being shipped assembled to complete rounds; it may also be used with the M61 fuze for the 120-mm. antiaircraft gun.

The M21 Series of Boosters. In order to understand the functioning of this series of boosters, especially as related to the M20A1 booster, they will be discussed in order.

The M21 booster is a modification of the M20 booster for use with separately issued point fuzes on shell 4.5 in. and larger. The setback pin (*P*) is omitted because centrifugal force may be insufficient to hold

it in the armed position. Because of a weaker centrifugal pin spring (*K*) which might accidentally be armed by a side thrust in handling, a pull pin (*C*) is added to hold the rotor (*H*) in the unarmed position. The M21A1 booster is the same except that the flash hole is larger in diameter.

The M21A2 booster employs a setback pin (*P*) of the "wiggly pin" type with a minimum modification of existing parts. A later development consists of a single-piece setback pin with a conical bottom locked

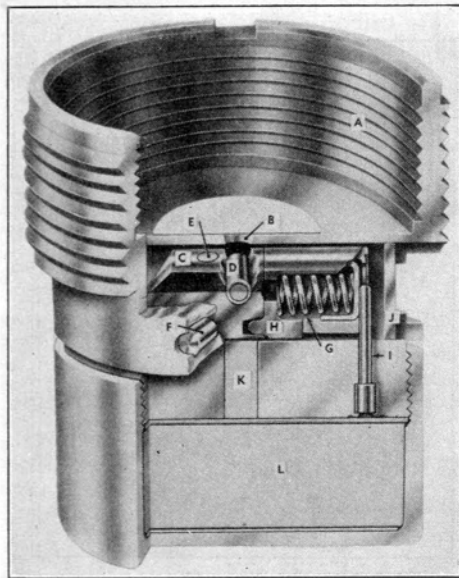

FIG. 80. M24 artillery booster.

in the armed position by a definite shoulder provided by the body closing plug. This is called the M21A4, and it functions in the same way as the M20A1 (except for the pull pin). The M21A4 booster may replace the M20A1 in all calibers.

The M51 fuze consists of the M48 fuze assembled to its booster, the M21A4 being standard for this purpose. The M20A1 booster was formerly used.

The M24 Booster. This is a recent design of a booster to replace both the M20 and M21 types to correct some of the difficulties and provide a universal standard booster for all fuzes and ammunition 75 mm. and larger. The centrifugal and setback pins and the flat water rotor, Fig. 80, are replaced by a full rotor (*C*) containing a detonator (*D*) held in the unarmed position at an angle to the fuze axis. This rotor is of the Simple type and is locked in the unarmed position by a centrifugal pin

(*H*) of the same diameter as the rotor, which pin moves out by centrifugal force. This action releases the rotor, which rotates to the armed position and is locked there by a pin (*E*) in the rotor which snaps out into a recess. The centrifugal pin is so designed that it moves outwards against a spring (*G*) held in place in a cup against a stop (*I*), the rotor cavity being closed by a disc (*J*). The explosive train consists of a two-part detonator (*D*) functioned through a flash hole (*B*), a booster lead (*K*), and a booster (*L*). Centrifugal force alone performs arming.

The booster body (*A*) may be made from bar stock on screw machines or from stampings. It is simple of construction and positive in operation, requiring rotation only to arm it. The screw machine type is shown in Fig. 80.

The M25 Booster. This is the M21A4 booster made shorter for use with the M78 concrete-piercing fuze discussed in Art. 22.

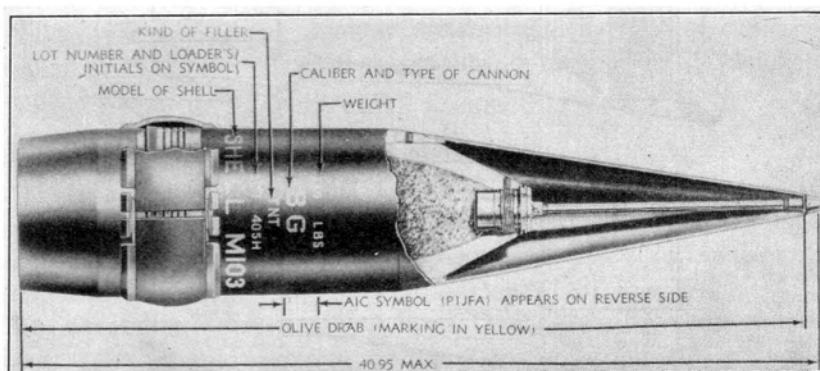

FIG. 81. 8-in. false-ogive projectile.

30. Fuzes for False-Ogive Projectiles.

In an effort to obtain the maximum possible range of a high-explosive projectile, both the shell and the fuze must be streamlined to the utmost, and the contour of the standard fuzes is much too blunt. Therefore, a false ogive is added to the nose of the shell, and the standard M51 fuze is modified to fit it, as shown in Fig. 81, the modified fuze being called M51 Mod 3.

The shell ogive replaces the fuze ogive, and the central tube of the fuze is made much longer but is still suitable to take either the regular superquick element or a shipping plug. The shell is shipped with false ogive, shipping head extension tube, and fuze body as shown in Fig. 82a. The fuze is always set superquick when assembled. When ready to fire, the shipping head is left in if delay action is required, as under this

condition there is no front-end unit to fire on impact, and the inertia plunger will function to give delay action. If superquick functioning is desired the shipping head is replaced by the usual superquick element, Fig. 82b.

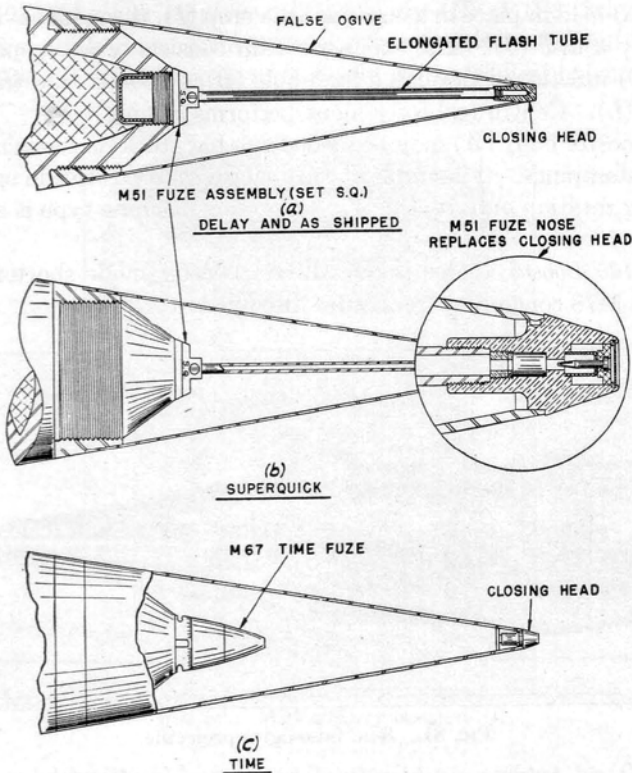

FIG. 82. Superquick, delay, and time fuzing for false-ogive projectile.

False-ogive projectiles could be fired with standard time fuzes by merely enclosing the time fuze with a false-ogive and shipping head, which is removed to set the fuze, as in Fig. 82c.

The false-ogive and modified fuze is used on the M103 8-in. projectile, the range being increased from about 21,000 yd. for the Mk I projectile with standard fuze contour to about 35,600 yd. Also 155-mm. shell have been so modified for this type of fuzing. The M103 complete projectile so fuzed is shown in Fig. 81.

CHAPTER 7

ARTILLERY COMPLETE ROUNDS

1. General.

A COMPLETE ROUND of artillery ammunition consists of all the components necessary to fire the weapon once. These components may actually be assembled together so that the round is a unit, all the parts being rigidly attached together, or the components may not be attached to one another but may consist of two or more separate items. We have already considered in detail two of the most important parts of an artillery complete round, namely, the shell and its filler or explosive charge, and the fuze. The other components making up the complete round will be discussed.

2. Components of the Complete Round.

Every complete round must have at least two fundamental parts, namely, the parts that leave the weapon, collectively called the projectile, and the parts that propel the projectile and remain in the weapon. Specifically, these parts are:

(a) Projectile, with or without fuze, which leaves the weapon upon firing.

(b) Propelling charge, which forces the projectile out of the weapon.

(c) Primer, to ignite the propelling charge.

(d) Propellent-powder container, either a cartridge case, or suitable powder bags, or both.

3. Types of Complete Rounds.

Classified according to Propellent Powder. Artillery complete rounds are divided into three types, depending upon the method of containing the propellent charge as follows:

1. **FIXED AMMUNITION**, the propellent powder being contained directly in a cartridge case rigidly fixed to the projectile.

2. **SEMIFIXED AMMUNITION**, the propellent powder being contained in several bags which are in turn contained in a cartridge case, the case being loosely attached to the projectile so that it can be removed before firing in order to adjust the charge to obtain different velocities and ranges.

3. **SEPARATE-LOADED AMMUNITION**, the propellant charge being contained in separate bags and loaded behind the projectile in the breech.

Fixed and semifixed ammunition is loaded into the weapon as a unit, being self-contained and ready to fire. Separate-loaded ammunition components are loaded into the weapon separately; first the projectile

is inserted and rammed home, then the bags of powder immediately to the rear of the projectile, and, after the breech is closed, the primer is inserted in the firing mechanism. Special cases of separate-loaded ammunition are the 120-mm. anti-aircraft complete round, which will be discussed under "Separate-Loaded Ammunition," and a 90-mm. tank complete round. These three types of complete rounds are characterized by other features as well. Fixed and semifixed rounds are fuzeed in the assembly plant whereas separate-loaded rounds are fuzeed in the field. Fixed and semifixed rounds are elaborately packed to withstand handling and shipping and to protect components including the powder from moisture and deterioration. Separate-loaded projectiles are shipped with an eyebolt lifting plug in the nose and a grommet around the rotating band for its protection, and without other packing. Separate-loaded powder charges have their own protective metal containers. Fuzes for separate-loaded ammunition are shipped attached to their boosters in suitable metal containers to be opened in the field.

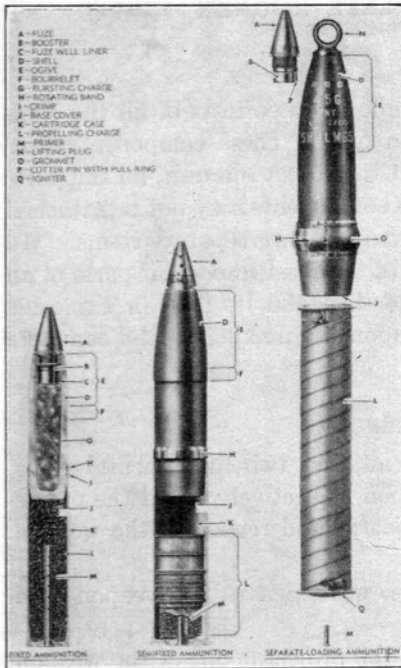

FIG. 83. Fixed, semifixed, and separate-loaded artillery rounds.

The three types of ammunition are shown in Fig. 83.

Classified according to Service Use. Complete rounds are also classified according to their use. **SERVICE AMMUNITION** is designed to inflict damage on the enemy by performing useful work at the target. **PRACTICE AMMUNITION** is designed for training troops and contains some type of low explosive or spotting charge. **DRILL AMMUNITION** is designed to train gun crews in going through the motions of loading and firing a

weapon without actually firing it in order to coordinate their movements properly. BLANK AMMUNITION is designed for saluting purposes. Since the projectiles for these types have already been discussed in detail, the rounds will not be discussed further from this standpoint, except to say that service and practice ammunition must have the same characteristics and be interchangeable because velocity, range, and ballistic properties must be identical.

Classified according to Tactical Use. Complete rounds are classified according to the projectile, as HIGH-EXPLOSIVE, ARMOR-PIERCING, CHEMICAL, SMOKE, ILLUMINATING, CANISTER, etc. Modern weapons are designed to be as versatile as possible in that they are designed to fire ammunition of types other than the primary type for which they were developed. An antitank gun, for example, fires high-explosive and smoke ammunition as well as armor-piercing ammunition. An antiaircraft gun may fire armor-piercing and smoke ammunition as well as high-explosive ammunition. A field gun fires canister as well as high-explosive and smoke ammunition. And, of course, all weapons fire practice, drill, and blank ammunition if it has been designed for them.

Artillery complete rounds may also be classified according to the type of artillery from which they are fired. The general classifications are mobile artillery, railway and seacoast artillery, tank armament artillery, antiaircraft artillery, and aircraft armament artillery. The calibers used by the Army in World War II in each of these categories are given in the table.

ARTILLERY

MOBILE	RAILWAY AND SEACOAST	TANK ARMAMENT	ANTI-AIRCRAFT	AIRCRAFT ARMAMENT
60-mm. mortar	6-in. gun	37-mm. gun	37-mm. gun	20-mm. gun
81-mm. mortar	155-mm. gun	75-mm. gun	40-mm. gun	37-mm. gun
20-mm. gun	8-in. gun	76-mm. gun	3-in. gun	75-mm. gun
37-mm. gun	12-in. gun	3-in. gun	90-mm. gun	
57-mm. gun	16-in. gun	90-mm. gun	105-mm. gun	
75-mm. pack howitzer		105-mm. howitzer	120-mm. gun	
75-mm. field howitzer		2-in. mortar		
75-mm. field gun				
3-in. gun				
105-mm. howitzer				
4.5-in. gun				
155-mm. howitzer				
155-mm. gun				
8-in. howitzer				
8-in. gun				
240-mm. howitzer				

4. General Requirements.

Of course, it may be that different range tables may be required because of the different weights and ballistic characteristics of the various types of ammunition fired from one type of weapon. The perfect situation would be to have all types of rounds—high-explosive, armor-piercing, smoke, etc.—all weigh exactly the same and have the same ballistics, and this ideal is sometimes reached with respect to two or more types of ammunition for a particular gun. For example, the high-explosive and armor-piercing projectiles for the 40-mm. M1 gun both weigh exactly 1.96 lb. as fired and are of the same contour. For the 75-mm. gun, the high-explosive projectile weighs 14.7 lb., the armor-piercing projectile 14.9 lb., and the smoke projectile 15.0 lb. as fired. The high-explosive projectile for the 155-mm. gun weighs 94.7 lb., and the smoke projectile weighs 98.4 lb., as fired. The weight of the projectile as fired is therefore a very important consideration, and the weight of new ammunition for an old gun is usually determined by such considerations. Of course, when a new weapon is under development, the weight of the projectile can be more or less as desired, but even here the weight is usually determined by the range desired, the amount of explosive or the amount of penetration desired, and the other military requirements.

5. Nomenclature.

Separate T and M numbers are not assigned to complete rounds, but the complete round derives its nomenclature from the particular type of projectile forming it. Thus, the complete round for the 37-mm. M63 base-fuzed high-explosive projectile is called Shell, Fixed, HE, M63, w/Fuze, BD, M58, 37 mm., the word "fixed" indicating a round and not a fuzed projectile alone. Similarly, a 75-mm. high-explosive howitzer round is called Shell, Semifixed, HE, M48, w/Fuze, TSQ, M54, 75 mm. How., and would be followed by the nomenclature of the howitzer. No composite nomenclature is needed for the complete round of separate-loaded ammunition, as the projectile with its nomenclature and the charge with its nomenclature are both specified.

For rounds used in infantry weapons, such as 20-mm. ammunition and certain 57- and 75-mm. infantry guns, the complete-round nomenclature is similar to small-arms nomenclature in that the complete round is called a CARTRIDGE. Thus, the high-explosive incendiary 20-mm. complete round is called "Cartridge, HEI, Mk I, w/Fuze, percussion, DA, No. 253 Mk I/A/, 20 mm.," and the armor-piercing round is called "Cartridge, AP-T, M75, 20 mm."

6. Painting and Marking Colors of Artillery Rounds.

Artillery rounds are painted the usual colors and marked in the usual way for protection and identification. Table 12 indicates the colors.

TABLE 12

TYPE OF SHELL	SHELL COLOR	COLOR BANDS ON BODY	MARKING (LETTERS AND FIGURES)
High-explosive	Olive drab		Yellow
Armor-piercing			
With HE	Olive drab		Yellow
Without HE	Black		White
Chemical	Gray		Same color as band
Non-persistent toxic gas		1 green band	
Persistent toxic gas		2 green bands	
Persistent harassing agent		2 red bands	
Smoke		1 yellow band	
Practice	Blue		White
Dummy or drill (Inert)	Black		White

Twenty-millimeter rounds are not marked according to Table 12. The HEI round has a yellow nose and a red body; the AP-T, ball, and practice projectiles are painted black; the incendiary projectiles are painted gray with blue tip.

FIXED AMMUNITION

7. General.

Fixed ammunition is found in all calibers from 20-mm. to 105-mm. inclusive, and ammunition for 20-, 37-, 40-, 57-, and 90-mm. and 3-in. weapons is made in the fixed type only. The 75- and 105-mm. gun ammunition is fixed but the 75- and 105-mm. howitzer ammunition is semifixed. The largest cartridge case in American fixed ammunition is for the 105-mm. AA gun with 11 lb. of propellant powder. Cases are attached to the shell by crimping to a groove in the shell, the groove usually being 360° and the case crimp being either 360° or of the multiple stab type. Primers are press fits in the cases.

8. Cartridge Cases.

Cartridge cases are made primarily from brass by a succession of draws from flat stock with suitable annealing between draws. This process results in a one-piece case with a comparatively heavy base and walls tapering to a thin section at the mouth where the case is crimped to the projectile. Typical cartridge cases are shown in Figs. 84, 85, and

87. Since 1941 a program to develop steel cartridge cases has been in progress, and satisfactory cases for many caliber are already in use, particularly for 20-, 37-, 40-, 57-, and 75-mm. and 3-in. rounds. When the round is fired, the crimp is broken and the case likely to be deformed at the mouth and throughout its length; although cases may be resized, they are seldom used over again in wartime. Cases such as 20-mm. and other automatic weapon cases are not used over again.

An important consideration in cartridge-case design is the DENSITY OF LOADING. If W_c is the weight of the propelling charge in pounds, and V_c is the capacity of the case in cubic inches, then the density of loading with water as a standard may be expressed by:

$$B = \frac{27.68W_c}{V_c} = \frac{\text{Weight of powder charge}}{\text{Weight of water to fill powder chamber}} \quad (26)$$

The figure 27.68 is the number of cubic inches per pound of water, and the density of loading based on water is usually 0.3 to 0.7. Of course, the higher the density of loading, the higher the gun pressure for a given powder, and it is for this reason, as well as others, that loading authorizations are required.

A rough approximation of the weight of propelling charge can be made from the weight of the projectile (W lb.), velocity (V ft./sec.), and the foot-tons of energy in powder for a similar weapon (Q):

$$W_c = \frac{WV^2}{4480gQ} \quad (27)$$

The average density of powder is 0.029 lb./cu. in. as loaded (not of the material itself), and the density of loading can also be estimated from that figure.

9. Study of 37-mm. Fixed Rounds.

Because 37-mm. guns are made in a variety of types, taking cartridge cases of three different lengths to accommodate the different gun chambers, and because each gun fires ammunition of a variety of types, this ammunition will be discussed in detail.

Types of Guns. The 37-mm. guns are used in the field as mobile artillery including the mobile antitank gun, or mounted inside a tank as tank armament, or as antiaircraft artillery to fire against planes, or mounted in a plane as aircraft armament. The original field guns have been replaced by antitank guns which are mobile and fire high-explosive as well as armor-piercing projectiles. The 1916 field gun tube is used as a subcaliber gun, mounted on a 75- or 155-mm. gun, primarily for

practice purposes. The M3A1 antitank gun, used also as a field gun (weighing under 1000 lb. total, including recoil mechanism and carriage), and the M5A1 and M6 tank guns fire the same ammunition. The M1A2 antiaircraft gun (6124 lb. total) is fully automatic and fires

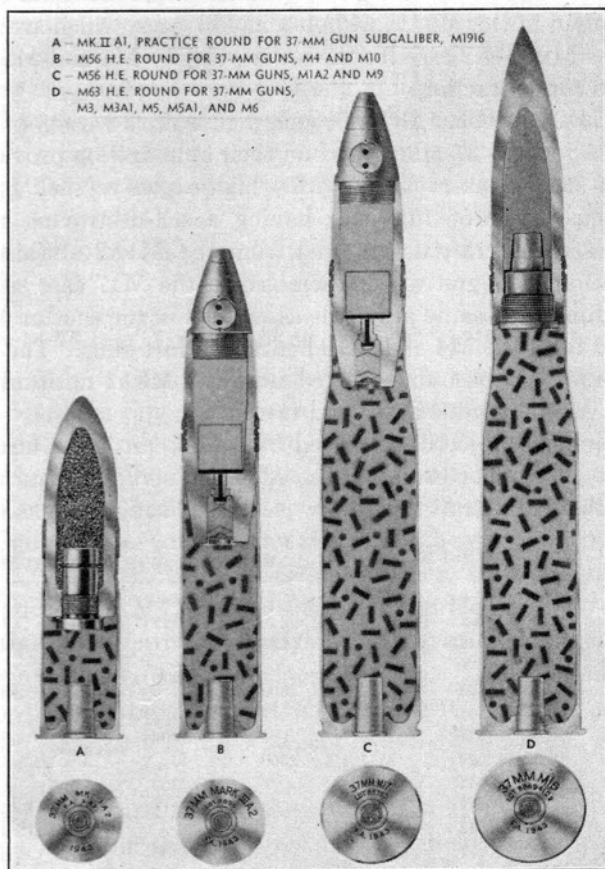

FIG. 84. 37-mm. complete rounds.

armor-piercing as well as high-explosive ammunition. The M4 and M10 automatic aircraft guns fire lighter ammunition against either other planes or ground targets, but the newer M9 aircraft gun fires ammunition at a higher velocity against both types of targets.

Types of Cases. Three sizes of cartridge cases are used on 37-mm. ammunition, as shown in Fig. 84. The very short Mk IA2 case is only $3\frac{1}{2}$ in. long, contains about 0.07 lb. of powder, and is used in the 1916 subcaliber gun. The Mk IIIA2 case is 5.7 in. long, contains about

0.15 lb. of powder, and is used with the lower-velocity M4 and M10 aircraft guns. The M16 and M17 cases are both $8\frac{3}{4}$ in. long and contain from 0.30 to 0.50 lb. of powder, the difference being that the M17 case has an extractor groove for use with the M1A2 automatic antiaircraft and the M9 automatic aircraft guns, whereas the M16 has an extracting rim and is used in the M3A1, M5A1, and M6 guns, which are not automatic. The Mk IIIA2 case for the lower-velocity M4 and M10 aircraft guns is also rim extracting.

Types of Ammunition. All four modern guns fire a variety of ammunition, and the various 37-mm. guns and their ammunition provide a good example of such flexibility. The M54 high-explosive shell fuzed with the supersensitive M56 fuze and having a self-destroying tracer for aircraft and antiaircraft use is fired from the M1A2 antiaircraft gun and the M9 aircraft gun when assembled in the M17 case suitable for automatic fire. The same projectile assembled in the shorter Mk IIIA2 case is fired from the M4 and M10 lighter aircraft guns. The M63 HE shell with the M58 base fuze is fired from the M3A1 antitank and the M5A1 and M6 tank guns at ground targets.

Armor-piercing projectiles are fired from tank, antitank, aircraft, and antiaircraft guns. For example, the M74 AP shot with tracer may be fired from the antiaircraft gun at low elevations against tanks and other

VELOCITY WHEN FIRED IN GUN

PROJECTILE	WEIGHT AS FIRED	POW- DER CHARGE	CASE	VELOCITY WHEN FIRED IN GUN				1916 SUB- CALIBER
				M1A2AA	M3A1AT M5A1T M6T	M4A M10A	M9A	
M54 HE	1.34	0.38	M17	2600	2600	..
M54 HE	1.34	.15	Mk IIIA2	2000
M63 HE	1.61	.44	M16	2600
M74 AP	1.92	.25	M17	2900
M74 AP	1.92	.44	M16	2900
M59 APC	1.91	.31	M17	2050
M59 APC	1.91	.52	M17	2800	..
M51 APC	1.92	.51	M16	2900
M80 AP	1.66	.14	Mk IIIA2	1825
M80 AP	1.66	.56	M17	3050	..
M55 Prac	1.34	.38	M17	*	*	..
M55 Prac	1.34	.15	Mk IIIA2	*
M51 TP	1.92	.44	*
Mk IIA1 Prac	1.23	.07	Mk IA2	*
M92 Prac	1.21	.07	Mk IA2	*
M63 Mod (Prac)	1.63	.06	Mk IA2	*
M21 Drill	*	..
M13 Drill	*
M23 Drill	*
Blank20	*
M2 Canister	1.89	.48	2500

* Used in this weapon but velocity not a factor.

ground targets, as well as from the tank and antitank guns. The M59 APC shot may be fired not only from the tank and antitank guns but also from the antiaircraft and the aircraft guns.

Practice ammunition is available for these weapons, as shown in the table. The antitank gun functions as a field gun and as such fires the greatest variety of ammunition including HE, AP, APC, practice, drill, blank, and canister.

The newer antiaircraft and antitank guns are high-velocity weapons compared to the older field and aircraft guns, but the newer M9 aircraft gun is a very high-velocity weapon; also, for each weapon some type of drill and practice ammunition is furnished, thus rounding out the full complement.

All ammunition for 37-mm. guns is listed in the usual complete-round tables.

10. Study of 75-mm. Fixed Rounds.

Since all 75-mm. guns are chambered to take the same M18 case, ammunition for these guns is somewhat simpler than that for 37-mm. guns. Now 75-mm. guns exist in the field, tank, aircraft, and subcaliber types. The field gun is really a combination field and antitank gun firing both high-explosive and armor-piercing ammunition at about 2000 ft./sec. The tank gun and the aircraft gun also fire both types at about the same velocity. The subcaliber gun is mounted on a larger gun tube for practice purposes. A 75-mm. antiaircraft gun has been developed, but it is not in general use, the 90- and 120-mm. antiaircraft guns of larger caliber being required against modern aircraft. The field and tank guns fire armor-piercing projectiles at about 2000 ft./sec., and the 75-mm. high-velocity antitank gun has largely replaced the 75-mm. gun against tanks.

The 1897, 1916, and 1917 field guns fire the M48 high-explosive shell with either the M48 or M54 fuzes at either reduced, normal, or super charge, the velocity being from 950 to 2000 ft./sec. They also fire the M61 AP shell with M66A1 base fuze, usually at supercharge, to give about 2000 ft./sec., or the same shell without charge and fuze. The M72 AP monobloc shot is fired at supercharge to give about 2000 ft./sec., and the M64 chemical and smoke projectile with the M57 fuze is also fired.

The M3 tank gun and the M4, M5, and T13E1 aircraft guns fire the M48 high-explosive and the M61 AP shell. Drill and blank ammunition are also available. The usual complete-round tables list all data for 75-mm. gun ammunition.

Figure 85 shows the 3-in. complete rounds, one with large case and M43 time fuze for antiaircraft fire, and one with a smaller case and M48 fuze for field fire, both with spacers to keep the propelling charge in place.

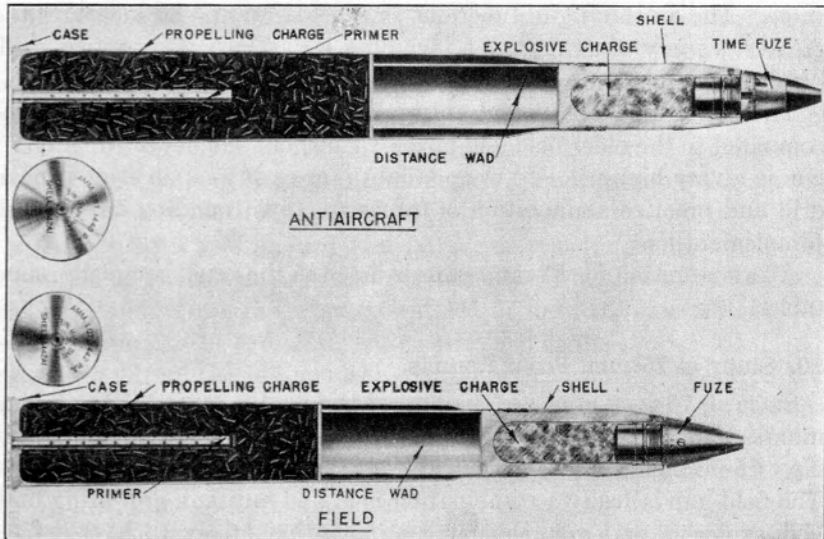

FIG. 85. 3-in. artillery rounds.

SEMIFIXED AMMUNITION

11. General.

Semifixed ammunition differs from fixed ammunition in that the cartridge case is not crimped to the projectile but is a loose fit so that it can be removed and the propelling charge adjusted to vary the range. Therefore, the charge is contained in bags so that one or more of these bags can be removed and the rest replaced. This type of ammunition exists for the 75- and 105-mm. howitzers only. Obviously, such ammunition would not apply to guns, where maximum range is desired, but are ideally suited to mobile howitzers, for which flexibility in range is just as important as long range. In fact, the purpose of all howitzers, whether they take semifixed or separate-loaded ammunition, is to combine great flexibility in range with mobility, and this range variation can be obtained only with powder charges that are easily varied, as are those for semifixed or separate-loaded ammunition.

Semifixed ammunition employs the same general type of case and primer as fixed ammunition. An exception to the rule that 75- and

105-mm. howitzers take semifixed ammunition are the M66 and M67 HEAT projectiles for which the case is crimped to the projectile because these rounds are fired at short ranges at tanks, and variation of range is not a factor.

Figure 86 illustrates a typical semifixed round in cross section, showing the powder in amounts contained in bags, in a case not crimped to the projectile.



FIG. 86. Typical semifixed complete round.

12. Propelling Charges.

The propelling charge for the 75-mm. howitzer consists of a base charge plus three increments, both the base charge and each of the increments being of unequal weight. All the sections are contained in cloth bags and marked with numbers beginning with 1 for the base charge, 2 for the first increment, etc., the number indicating the number of the charge. The first increment is tied to the base charge with a long twine, the other increments being tied to each other with shorter twine, and the base section is tied to the bottom of the case. All increments (but not the base charge) may therefore be pulled up to the mouth of the case, and increments not desired may be removed by cutting or breaking the twine, those to be used being dropped back in the case.

The increment with the number of the charge to be fired is uppermost because all sections up to and including the number of the charge to be fired are required to fire that particular charge. It is not permitted to "skip," say remove the first and third increments, leaving the base and second increment only; all increments must be consecutive up to and including the number of the charge to be used.

The propelling charge for the 105-mm. howitzer is similar except that there are more increments. The M2, M2A1, and M4 howitzers have seven zones, base and six increments; the M3 howitzer has five zones, base and four increments. The various velocities and ranges for typical rounds on 75 and 105 howitzers are given in the table.

ARTILLERY COMPLETE ROUNDS

ZONE	M48 HE ROUND IN M1, M2, AND M3 75-MM.		M1 HE ROUND IN M2 AND M4 105-MM.		M1 HE ROUND IN M3 105-MM.	
	HOWITZERS		HOWITZERS		HOWITZER	
	Velocity	Maximum Range	Velocity	Maximum Range	Velocity	Maximum Range
1	700	4190	650	3,800	650	3800
2	810	5360	710	4,500	710	4500
3	950	6930	780	5,300	780	5300
4	1250	9610	875	6,400	875	6400
5			1020	8,300	1020	8300
6			1235	10,100		
7			1550	12,200		

Information regarding the material of the bags will be given under "Separate-Loaded Ammunition." The 105-mm. rounds for the M2, M3, and M4 howitzers are shown in Fig. 87.

13. Ammunition for 75-mm. Howitzers.

Three howitzers are now available: the M1 or M1A1 pack howitzer, originally designed for animal draft, and redesigned for operation in mountainous territory or for airborne use; the M1 field howitzer, somewhat heavier, and for general field use; and the M2 and M3 tank howitzers, mounted in tanks or combat vehicles for tank support, antitank defense, and tank offense. All models have the same chamber design and take the same ammunition.

High-explosive ammunition consists of the M48 round with M48 or M54 fuze or the M41A1 round with the same fuzes; smoke or chemical ammunition consists of the M64 round with M57 fuze; armor-piercing ammunition consists of the M66 HEAT shaped-charge round with M62 base fuze. Penetration of the last-mentioned fixed round is independent of range, within reasonable limits, because of operation by the shaped-charge principle, and this round is expected to penetrate $3\frac{5}{8}$ in. of homogeneous plate when impact is normal to the plate.

14. Ammunition for 105-mm. Howitzers.

There are three 105-mm. howitzers: the M2 and M2A1 field howitzers used by the armored force, and firing a variety of ammunition at about 1550 ft./sec. maximum; the M3 light field howitzer, which is used by the infantry and may be airborne, firing ammunition at 1000 ft./sec. maximum; and the M4 tank howitzer, mounted on the medium tank, and having a velocity of 1550 ft./sec. maximum. All fire the same ammunition because they have the same chamber design. High-explosive am-

munition consists of the M1 HE round, with the M48 or M54 fuze; chemical ammunition consists of the M60 round with the M57 fuze; smoke ammunition consists of the M60 WP round with M57 fuze and the

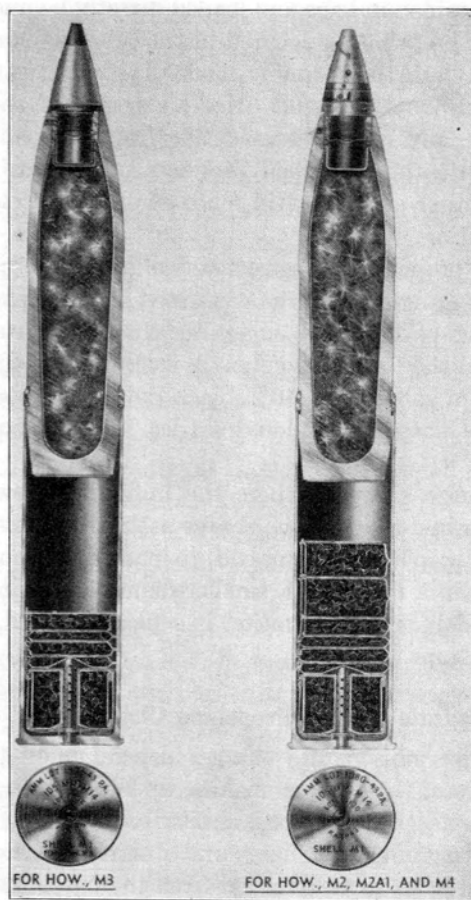

FIG. 87. 105-mm. howitzer complete round.

M84 BE round with the M54 fuze, using either white or colored smoke; armor-piercing ammunition consists of the M67 HEAT round with M62 fuze, the companion round to the M66 HEAT 75-mm. round. This round should penetrate 4 in. of homogeneous plate at the usual short range and at normal impact. The principal advantage of the M66 and M67 rounds is that they allow a low-velocity and highly mobile weapon to fire armor-piercing ammunition.

SEPARATE-LOADED AMMUNITION

15. General.

Separate-loaded ammunition has no cartridge case, the propelling charge being contained in bags and loaded directly behind the projectile in the breech. The primer is located in the breech behind the powder.

Cartridge bag cloth was formerly made of silk, but cotton and rayon have satisfactorily replaced silk. Not all grades of these fabrics are suitable, because any residual smoldering fragments in the bore after firing might ignite the unburned products of combustion, causing a "flareback." Igniter pads are still made of silk, very closely woven so as to prevent sifting.

Each separate propelling charge consists of one or more bags of smokeless powder plus an igniter charge contained in a bag sewed to the end of the charge bag. Sometimes the igniter charge also runs through the powder charge in the form of a core. A flash-reducer charge consisting of 60% potassium sulfate and 40% black powder is sometimes used; it is in the form of flat strips, colored scarlet, and tied to the propelling powder.

For certain large charges, where the individual powder grains are large and it is desired to make the charge as small as possible, the grains are "stacked" by placing them end to end throughout the charge. Stacking results in a more rigid, smaller-diameter charge.

All 4.5-in. and larger ammunition is separate-loaded, whether it be for howitzers or guns.

16. Types of Separate-Loaded Propelling Charges.

The three types of separate charges depend upon the relationship between the sizes of the sections making up the charge.

Base and Increment. This type is similar to the charge of the semifixed howitzer, consisting of a base charge and a number of increments, either unequal or equal in size, but different from the base, and numbered like semifixed charges. The zones must be fired in the same way: if zone 6 is being fired, the base and five increments must be used. The base and increment type of separate loading is employed with the 155-mm. howitzer. An igniter pad may be attached to the base section only, or a core igniter may be used in the base section and in the increments as well.

Equal Section or Aliquot Part. This type consists of a given number of equal sections. The igniter pad may be separate, with tying straps provided to attach to the propellant charges, or an igniter pad may be attached to each part. An example of this type of separate-loaded charge is that for the 14-in. gun, consisting of the four equal sections.

Unequal Sections. This type of separate-loaded charge consists of several equal sections plus at least one section half as large. Although the sections are not all equal, they are related, and the ratio of the weight of larger sections to the smaller is 2 to 1. The 240-mm. howitzer charge is an example of the unequal-section charge and consists of four sections each weighing one-fifth of the total charge weight plus two sections each weighing one-tenth of the total charge.

17. Propelling Charge for the 155-mm. Howitzer M1.

As an example of the base-and-increment type of propelling charge for separate-loaded projectiles, consider the charge for the 155-mm. howitzer M1. Since the purpose of this howitzer is to fire to many varied ranges between the 155-mm. gun and lighter artillery weapons, the charge is divided into seven zones, consisting of a base charge and six increments. The charges are somewhat smaller than those for the 155-mm. gun and are therefore not putted, but are assembled by means of ties. If all seven parts of the charge were fastened together as a single charge, it would almost always be necessary to untie it and remove one or more of the increments, as full charge is wanted only a small part of the time. To provide for the combinations most generally required in the field so that they may be used with a minimum of increment adjustment and waste, two charges were originally issued, the M3 green bag charge and the M4 white bag charge.

The M3 green bag charge, as shown in Fig. 88, consists of the base charge plus four increments, each in an individual green bag of different weight, and tied together with green ties and having a red bag igniter charge sewed to the base charge. This arrangement provides inner zone firing of the first five zones, the total weight of the M3 charge being 5.9 lb.; velocities and ranges expected from these zones are shown in Table 13. As in semifixed howitzer charges, each zone must be fired with all the increments up to and including the number of the zone being fired, increments being removed from the largest number on down to the zone desired.

The M4 white bag charge, for firing in the outer zones only, consists of three white bags tied together with white ties, and with a red bag igniter sewed to the end of charge 5. This charge 5, all in one bag, gives the same velocity and range as the entire five charges in the green bag, but its weight is slightly different, because a somewhat faster powder is used. However, this illustrates the principle that a given zone number means a definite velocity and range, no matter how it is obtained. When the howitzer is fired with zone 5, the same results are obtained no matter whether the entire M3 charge of five bags is used or the single one-bag

zone 5 charge of the M4 charge. In addition to zone 5, the M4 charge has zones 6 and 7, the total weight being about 13.9 lb.

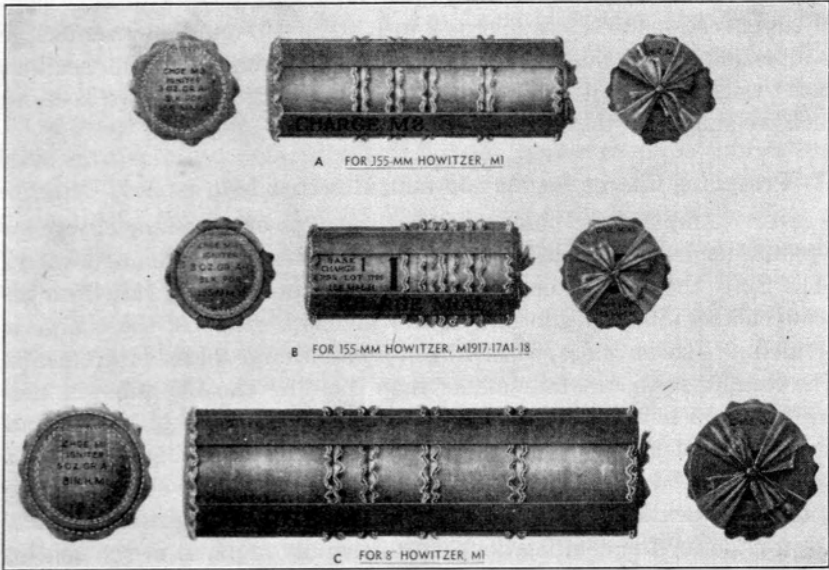

FIG. 88. Separate-loaded howitzer charges (green bag).

Because the M3 and M4 charges provide little overlap of the two charges, there being only one common zone, it was decided that for greater flexibility in the field a little more overlap should be provided. The M4A1 white bag, shown in Fig. 89, is designed for this purpose. It



FIG. 89. Separate-loaded howitzer charges (white bag).

consists of zones 3, 4, 5, 6, and 7, zone 3 being one white bag to give the same velocity and range as zone 3 of the M3 charge of three green bags or increments. Zones 4 and 5 of the M4A1 charge give the same velocities as zones 4 and 5 of the M3 charge, and zones 6 and 7 give the same velocities as zones 6 and 7 of the M4 charge. The weight of the M4A1 charge is the same as that of the M4 charge.

Figures 88 and 89 also show the M1A1 and M2A1 charges for the old M1917 series of howitzers.

TABLE 13

ZONE	VELOCITY ft./sec.	RANGE yd.	M3 GREEN	M4 WHITE	M4A1 WHITE
			BAG CHARGE	BAG CHARGE	BAG CHARGE
1	680	4,200	1		
2	770	5,400	2		
3	880	6,800	3		3
4	1020	8,620	4		4
5	1220	10,800	5	5	5
6	1520	13,400		6	6
7	1850	16,400		7	7

Propelling charges for the 8-in. howitzer are shown in Figs. 88 and 89.

18. Propelling Charge for 155-mm. Gun M1A1.

This propelling charge is an example of the base-and-increment type applied to a gun taking separate-loaded ammunition. The charge consists of a base plus one increment, and both are putteed with spiral wrapping because of their length. The increment is tied to the base with four straps as shown in Fig. 90, which also shows the charge for the M1917 gun. The base contains 20.35 lb. of NH powder, and the increment 10.35 lb., or a total of 30.70 lb., and the full charge is 6.5 in.

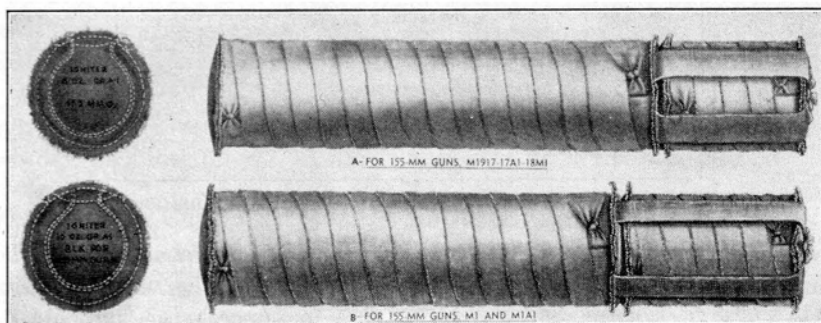

FIG. 90. 155-mm. gun propelling charges.

diameter and 37 in. long. An igniter charge is sewed to the rear end of the base section.

The base section alone is known as the normal charge, and the base and increment together are known as the supercharge, used only for

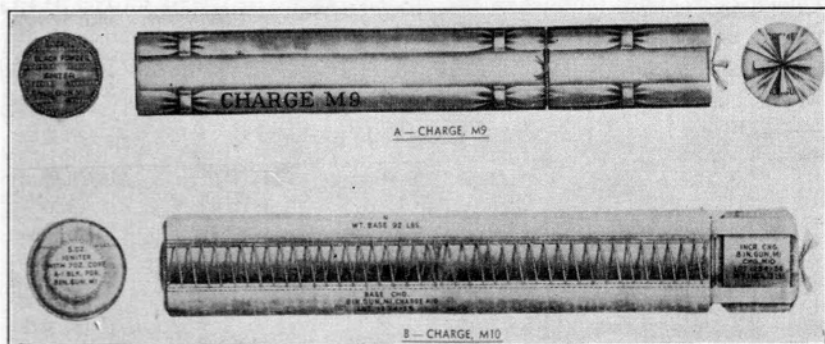

FIG. 91. 8-in. gun propelling charges.

extreme ranges. In order to reduce the muzzle flash, the M1 flash reducer, shown in Fig. 92, is tied around the propelling charge by means of silk tie strings. The strip has three channels, the middle one being filled with black powder and the two outer ones with a mixture of 60% potassium sulfate and 40% black powder; the strip itself is also divided into a base section and an increment section. The base section alone is used with the normal (base) propelling charge, and base and increment

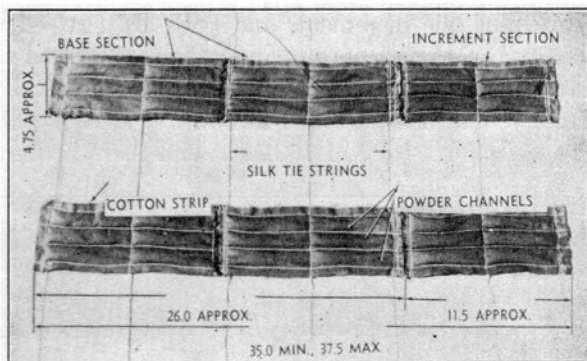

FIG. 92. Flash reducer for separate-loaded ammunition.

sections of the flash reducer are used with the supercharge (base and increment). Of course, the reducer also decrease the velocity about 15 ft./sec. for normal charge and 35 ft./sec. for supercharge, and ballistic correction must be made when the flash reducer is employed.

The 8-in. gun propellant charge is also of the base-and-increment type, as shown in Fig. 91.

19. Propelling Charge for 14-in. Gun.

The present standard propelling charge for the 14-in. gun is an example of the equal or aliquot part type charge. The individual grains of NH powder are STACKED or piled end to end throughout the charge in orderly fashion. One gun (M1909) takes a charge of two equal sections,

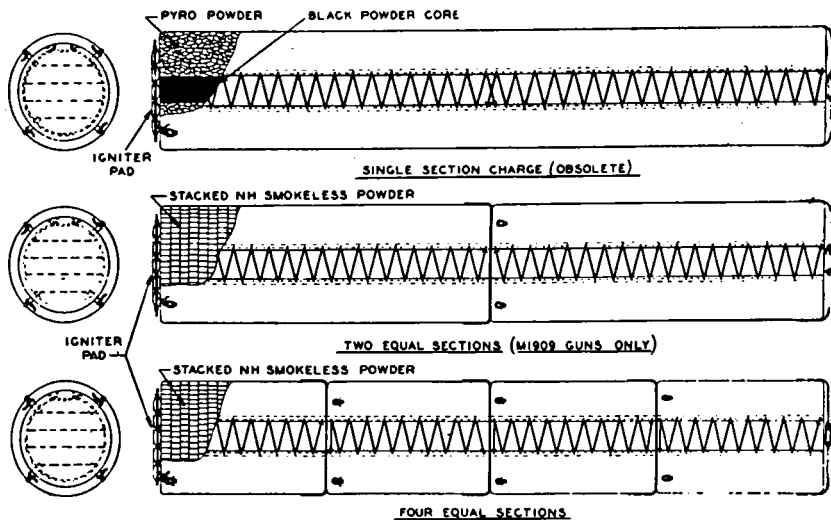

FIG. 93. 14-in. gun propelling charges.

and other guns a charge of four equal sections, the total charge varying from 320 to 480 lb. The quantity of powder for these large guns is so great that the charges are laced together as shown in Fig. 93. An igniter pad with 3 lb. of black powder is attached to one section of the charge with ordinary brass safety pins, which are removed before firing, the pad being held then only by stitching.

A single-section charge has been fired in this gun, and, because of the gun's length, a central igniter tube is used containing 72 oz. of black powder, in addition to an igniter bag with 14 oz. of black powder.

20. Propelling Charge for 240-mm. Howitzer.

The M1918 older 240-mm. howitzer used a propelling charge of the unequally related type, consisting of four equal sections each one-fifth of the total charge, and two equal sections each one-tenth of the total charge, all being tied together with tie straps. The total charge is about

37 lb., and, by dividing it into six sections, nine zones are possible, four more than can be obtained by having five equal sections. The charge, shown in Fig. 94, is almost 21 in. long, and a 5-oz. igniter is provided with tie straps to hold the charge together.

ZONE	COMPOSITION	PROPORTION OF TOTAL
1	Base ($\frac{1}{5}$ only)	0.2
2	Base + $\frac{1}{10}$	0.3
3	Base + $\frac{1}{5}$	0.4
4	Base + $\frac{1}{5}$ + $\frac{1}{10}$	0.5
5	Base + $\frac{1}{5}$ + $\frac{1}{5}$	0.6
6	Base + $\frac{1}{5}$ + $\frac{1}{5}$ + $\frac{1}{10}$	0.7
7	Base + $\frac{1}{5}$ + $\frac{1}{5}$ + $\frac{1}{5}$	0.8
8	Base + $\frac{1}{5}$ + $\frac{1}{5}$ + $\frac{1}{5}$ + $\frac{1}{10}$	0.9
9	Full charge	1.0

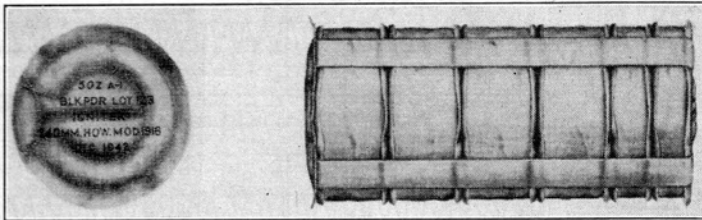

FIG. 94. 240-mm. howitzer propelling charge.

The M1 newer howitzer uses a base and increment type of charge, similar to that for the 155-mm. howitzer.

21. The 120-mm. (4.7-in.) Complete Round.

The 120-mm. (4.7-in.) antiaircraft gun was developed as a separate-loaded weapon in that the fuzed projectile is first placed in the gun, and then the powder charge. However, because this weapon is designed for automatic fire at comparatively high rates (10 rounds per minute), the powder charge is contained in a cartridge case instead of in bags. This case is the largest in use, being about 33 in. long, and its mouth is closed with a palmetto pulp or cork plug, which disintegrates when the 24-lb. powder charge burns.

This round, shown in Fig. 95, weighs almost 100 lb. The 50-lb. projectile has a muzzle velocity of 3100 ft./sec. at 38,000 lb./sq. in. chamber pressure, and the maximum altitude is about 19,000 yd., so that this weapon can fire against high-flying aircraft.

A similar round of the separate-loaded type with the propellant con-

tained in a cartridge case has been developed for a 90-mm. tank gun, where space limitations would prevent loading of a long fixed round such as is needed for high-velocity antitank work.

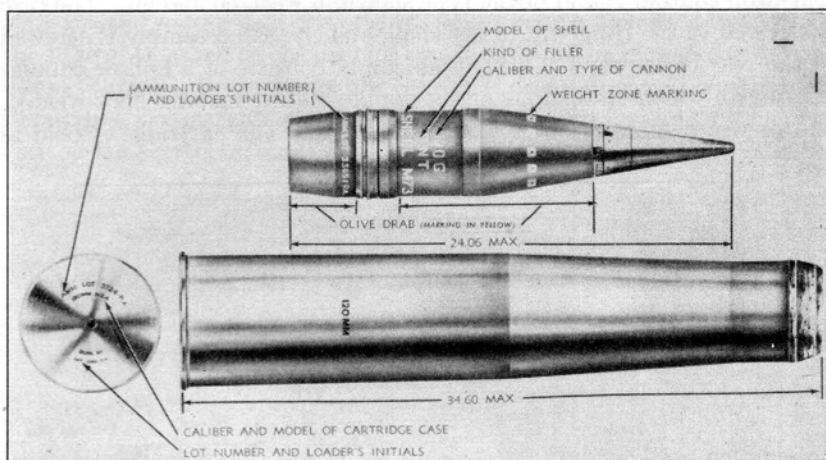

FIG. 95. 4.7-in. complete round.

MORTAR COMPLETE ROUNDS

22. General.

Mortars are used in missions where high angles of fire are desired for plunging fire behind hills or into trenches, placements, foxholes, etc. The muzzle velocities and ranges of mortars are less than those of guns and howitzers, but, because of their extreme mobility, they are used extensively by front-line infantry units, particularly in jungle warfare. Mortars allow ammunition of gun and howitzer caliber to be fired almost immediately after establishment of a beachhead.

Mortar rounds consist of TRENCH MORTAR ROUNDS of 60- and 81-mm. caliber, used on advanced positions; 4.2-in. CHEMICAL MORTAR ROUNDS, somewhat heavier, but still for front-line use; HEAVY MORTAR ROUNDS of 105- and 155-mm. caliber for use just behind front lines; and special large-caliber mortar rounds for demolition and destruction work, such as the 10-in. (250-mm.) MORTAR ROUND.

Most mortars are smooth-bore and muzzle-loaded, although the 4.2-in. mortar is a rifled muzzle-loaded weapon. Muzzle-loaded rounds must be complete as a unit so that, when they are dropped tail down in the weapon, impact with the firing pin is all that is needed to set off the propelling charge. Smooth-bore rounds must have fins to stabilize them since rotation is absent.

23. Parts of Mortar Complete Rounds.

Streamlined Trench Mortar Type (Smooth-Bore). Both the 60- and 81-mm. mortars fire a comparatively lightweight, streamlined, so-called tear-drop contour round of the type shown in Figs. 50 and 96. The fuze is screwed to the front end of the shell, and the tail assembly is screwed to the rear of the shell. The fin assembly consists of a hollow tubular housing to which either four or six double-bladed fins are spot-welded, and in which an ignition cartridge is placed. The cartridge is held in

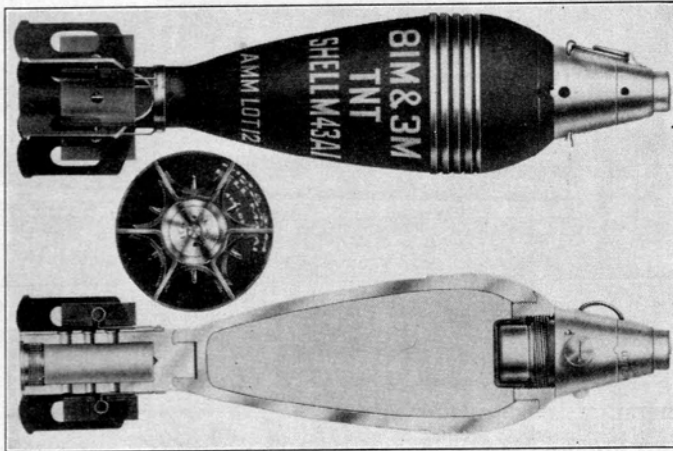

FIG. 96. 81-mm. mortar complete round.

place by a primer assembly of aluminum which screws into the end of the fin assembly. The propellant increments are fastened to the fins by means of special wire holders. Mortar rounds are therefore seen to be of the base-and-increment type; they may also be considered semifixed ammunition, since the charge can be adjusted in the field to obtain different zones of firing.

Cylindrical Trench Mortar Type (Smooth-Bore). The 81-mm. mortar also fires a heavier, cylindrical type of high-explosive round, the parts of which are shown in Fig. 51. The fuze is screwed into the nose, and the fin assembly is screwed into the tail cone. The propelling charge is of the same type, consisting of an ignition charge inside the fin assembly and increments having a round hole which fit over the tube ahead of the fins or in a special wire assembly.

Cylindrical Type (Rifled-Bore). The 4.2-in. chemical mortar round is constructed somewhat differently. The smoke bursting type has a nose fuze screwed to the nose, back of which is a long burster. The cavity

is filled with smoke mixture, two vanes preventing movement of the charge with respect to the projectile. The base of the shell has a pressure plate attached to it, so flanged that the pressure of the propellant gases forces the soft brass flange outward to act as a rotating band, imparting rotation and acting as a gas seal. The propelling charge is fastened to the base of the shell by means of a threaded stud, the increments of powder in the form of rings being placed over the container and held in place by an upper adjustable nut and a lower striker nut screwed to the open end of the cartridge container. The ignition cartridge fits into the

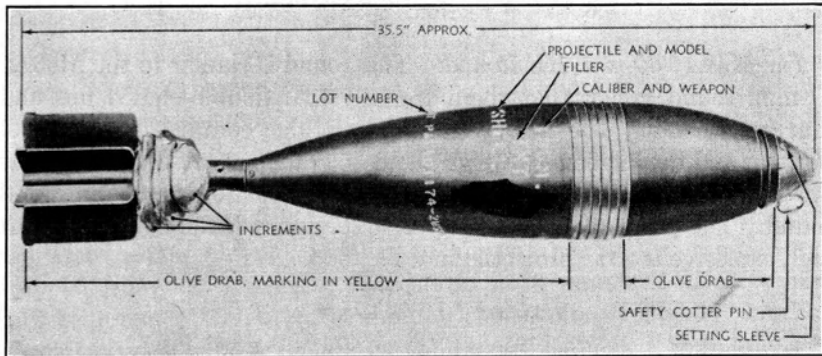

FIG. 97. 155-mm. mortar complete round.

container and is functioned by the striker in the nut being driven into the primer in the ignition cartridge.

The high-explosive round is constructed the same, but without the burster tube and baffles.

Streamlined Large-Caliber Type (Smooth-Bore). The 105- and 155-mm. smooth-bore mortars fire a heavy, streamlined projectile like that shown in Fig. 97.

24. Functioning of Mortar Rounds.

The M43A1 81-mm. HE Round. This is the lightweight tear-drop round for the 81-mm. mortar; it weighs 7.10 lb. as fired. The M6 ignition cartridge is colored red, and the cardboard body contains 120 grains of granulated black powder. The increments consist of sheets of double-base powder sewn together. Each increment weighs about 117 grains, and six are used, one between the double blades of each fin. These increments may be "nibbled" in order to get the correct weight, and they are packed individually in cellophane bags for protection against moisture. The increments are ignited by the cartridge powder flashing through holes in the stabilizer tube.

The total weight of propellant is about 822 grains, and there are six zones of fire in addition to zone 0 which consists of the base charge alone. The zone velocities and ranges are given in the table.

ZONE	VELOCITY	RANGE
0	235	541
1	332	1020
2	419	1502
3	449	2042
4	572	2517
5	638	2963
6	700	3300

The M49A2 60-mm. HE Round. This round is similar to the M43A1 81-mm. round except that there are only four double-bladed fins and four increments. The M5A1 ignition cartridge contains 40 grains of powder, and the increments weigh about 35 grains each. The increments are cellophane wrapped and supported the same as for the 81-mm. M43 round. The projectile weighs only 2.96 lb. as fired, the lightest-weight high-explosive mortar projectile in use.

ZONE	VELOCITY	RANGE
0	195	373 (with plastic fuze)
1	301	816
2	389	1244
3	463	1630
4	535	2017

The M56 81-mm. HE Round. This is the heavier 81-mm. round weighing 10.82 lb. as fired, about 40% of this weight being high explosive, so that the round is very effective against emplacements, barbed wire, machine-gun nests, and smaller fortifications. The M6 cartridge contains 120 grains of powder, and there are four increments each weighing about 205 grains. This M2 increment is cut square from sheets sewed together, nibbled to give the correct weight, packed in cellophane for protection, and held in place on the stabilizer tube by means of spring clips.

Because this heavy high-explosive round would be dangerous when fired with base charge alone and the fuze would not arm, it is fired only with increments, resulting in the following ballistics:

ZONE	VELOCITY	RANGE
1	306	875
2	412	1474
3	502	2046
4	583	2560

PART IV
AIRCRAFT AMMUNITION

CHAPTER 8

BOMBS

1. General.

AIRCRAFT AMMUNITION is defined as ammunition dropped from aircraft or as ammunition peculiar to aircraft. A modern bomber is equipped with machine guns firing small-arms ammunition, artillery in the form of 20-, 37-, and 75-mm. guns firing artillery ammunition, and rocket launchers firing rockets, but these three types of weapons and ammunition are not peculiar to aircraft nor is the ammunition dropped from the aircraft. The one type of ammunition satisfying both requirements is aircraft ammunition or, more generally, bombs. Aircraft torpedoes and submarine mines are launched from aircraft but are not considered aircraft ammunition.

Pyrotechnic devices dropped or fired from aircraft really constitute another class of aircraft ammunition. But not all pyrotechnics are peculiar to aircraft, as some are fired from the ground. Those pyrotechnic devices which are dropped or fired from aircraft, together with bombs, constitute aircraft ammunition. Aircraft pyrotechnics will be discussed in Chapter 10, and bombs will be discussed in this chapter.

In the first World War, aircraft ammunition was insignificant compared to artillery ammunition. Our air force had a caliber .30 machine gun on some of its planes and dropped some small bombs of about 100 lb. which were of British and French design, but aircraft ammunition as we know it today did not exist. The effect of bombing was largely the disturbing of morale rather than hitting a specific target or even bombing a definite area. In World War II, aircraft ammunition has become a definite and important branch of ammunition, and the number of sizes and types of bombs and bomb fuzes required for the highly accurate bombing of a great variety of targets is comparable to the number of sizes and types of artillery ammunition, the science of which predates aircraft ammunition by many years.

Whereas in artillery-ammunition design we have two conditions with which to contend, namely, setback and impact, in aircraft-ammunition

design we have only one, namely, impact, for bombs are merely dropped from aircraft instead of being shot from a weapon with large initial acceleration. The first reaction, therefore, might be to assume that the design of the metal parts of bombs and bomb fuzes might be relatively simple because of the absence of setback stresses and because bombs fall freely. Nothing could be further from the truth; a consideration of the types of targets together with modern methods of bombing will convince the

TABLE 14
PROPORTIONS OF VARIOUS BOMBS

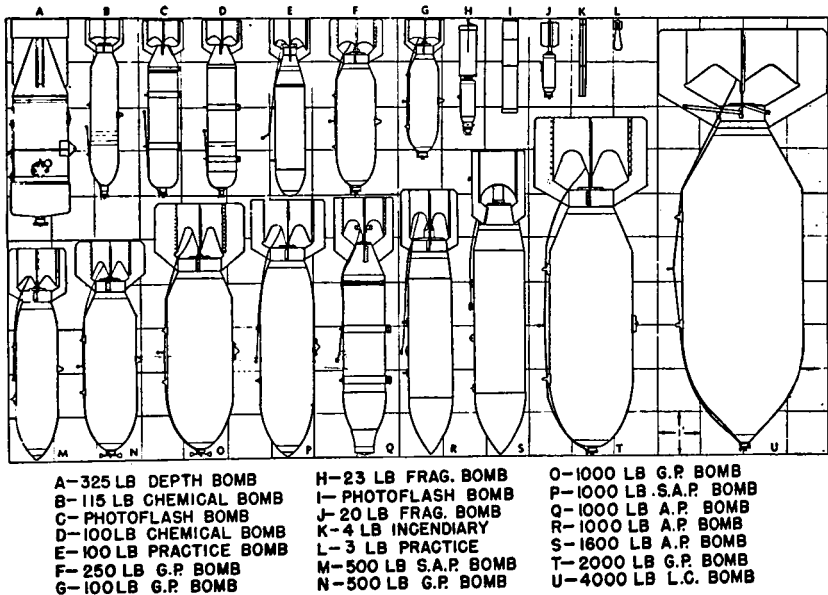

bomb designer that the impact stresses are extremely severe. There is nothing very ladylike about smashing a 500-lb. bomb up against the side armor of a cruiser at 600 ft./sec., or of dropping a 1000-lb. bomb on a railhead where it impacts against steel, bounces off, and hits again bottom side up or even sidewise. Good steel and high ultimate strength are required in bomb and bomb-fuze design just as in artillery-ammunition design.

Progress in bomb and bomb-fuze design has paralleled progress in the development of aircraft. Large planes with more bomb-carrying capacity have permitted larger bombs. Also the development of larger planes has resulted in the clustering of bombs so that, when small bombs are required for the target, more of them can be carried on a mission.

During the period between World War I and World War II, a line of GP bombs between 100 and 2000 lb. was developed, as well as a good fragmentation bomb, several chemical bombs, and some incendiary bombs. Since 1940, the high-capacity 4000-lb. bomb, several additional chemical bombs, both smaller and larger fragmentation bombs, and larger incendiary bombs have been developed. Also the number of bomb fuzes has tripled or even quadrupled within that time. Various bombs are shown in Table 14.

Since bombs are merely dropped from aircraft, the forces of setback and rotation utilized to arm artillery fuzes are absent, so that the bomb-fuze designer must resort to other means for incorporating safety into bomb design. In the discussion to follow, we shall see just how this is accomplished.

Table 15 will serve to illustrate, in a very general way, the differences between artillery and aircraft ammunition which the designer must keep in mind.

TABLE 15

PRINCIPAL DIFFERENCES BETWEEN ARTILLERY AND AIRCRAFT AMMUNITION

<i>Characteristic</i>	<i>Aircraft Ammunition (Bombs)</i>	<i>Artillery Ammunition (Projectiles)</i>
Direction of flight	Vertical	Horizontal
Branch of trajectory	Descending	Rising and descending
Velocity during flight	Increasing	Decreasing
Rotation	None	High
Method of stabilization	Surface (fins)	Rotation
Velocity relative to sound	Usually below	Usually above
Air resistance	Proportional to square of speed	Not proportional to square of speed
Size and weight	Up to 4000 lb. and 15 ft. long	Up to 16-in. diameter and 1500 lb.

2. Bomb Ballistics.

On this subject much has been written, but we are concerned here only with those aspects of bombing which affect the design of a bomb. Consider a bomb dropped from a plane flying at altitude VR , Fig. 98, from point R . Neglecting air resistance and side winds, the bomb has a forward motion equal to the speed of the plane which is a linear function of time, and a vertical motion downwards due to gravity which is a function of the square of the time. The path in a vacuum is therefore a parabola Rp_2GV_2 , and the plane will have moved the distance VV_1 during the time the bomb is falling. As the bomb falls, it gains speed and its angle of fall becomes increasingly steep, as measured by the tangent to the path. The fact that the plane, if it continues to move

on its course, will be directly over the bomb when it detonates (for vacuum fall) may represent a very dangerous condition, especially for low altitudes of release.

Because of air resistance (still neglecting side winds) the bomb does not descend as rapidly as if it were in a vacuum, and the actual air path Rp_1T falls short of the vacuum path by an amount TV_1 horizontally

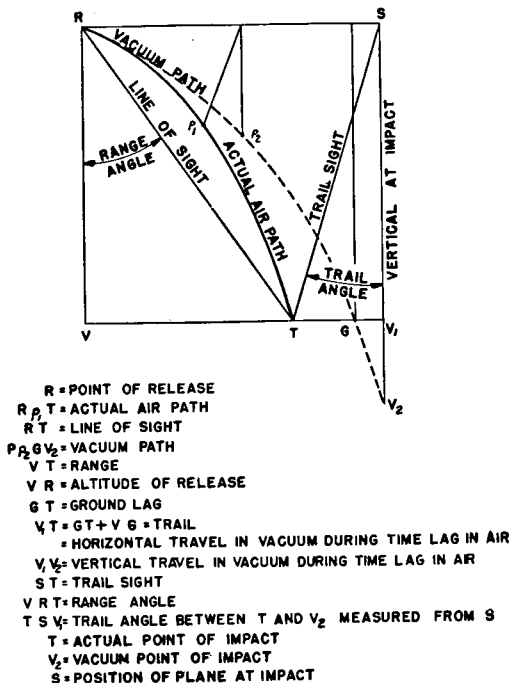

FIG. 98. Relation of actual air path to parabolic path for bomb dropped in air and vacuum.

and V_1V_2 vertically. The distance TV_1 is called the trail, ST the trail sight, and TSV_1 the trail angle. The distances TV_1 and V_1V_2 may be thought of as the horizontal and vertical travel, respectively, which would occur in a vacuum during the actual time lag caused by air resistance. VT is called the range, RT the line of sight, and VRT the range angle. For any point p_1 on the air trajectory, there is a corresponding point p_2 on the vacuum trajectory, somewhat beyond and below the point p_1 .

The plane will be at point S at impact, somewhat beyond the actual point of impact, but at low altitudes the lead is small, and provision for the safety of the plane must still be provided by means of a parachute

on the bomb to slow down its forward motion, or a delay fuze which delays detonation until the plane has moved forward a safe distance.

The designer of aircraft ammunition is interested in the velocity and angle of impact because the design of bomb cases and fuzes and particularly the time of functioning of fuzes is based on the impact conditions expected. Figure 99 shows the relationship for vacuum conditions between speed of the plane, altitude of release, velocity of the bomb at impact, and angle of impact. The designer will find this chart useful

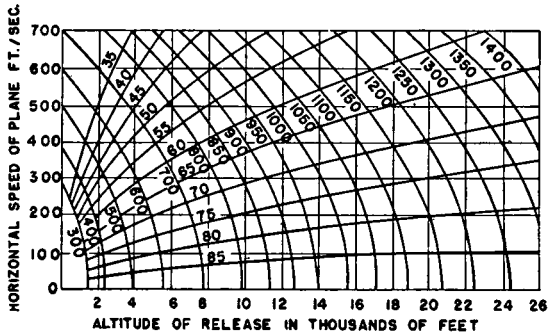

FIG. 99. Flight characteristics of bomb in vacuum showing angle of impact with horizontal and impact velocity for various speeds of plane and altitudes of release.

in determining the terminal conditions if it is remembered that air resistance and side winds have been neglected.

From the chart it is seen that a bomb released from a plane traveling 400 ft./sec. (275 mi./hr.) and from an altitude of 10,000 ft. will have a velocity of 900 ft./sec. at impact, and the impact angle will be 63° with the horizontal. A bomb released from a plane traveling 600 ft./sec. (410 mi./hr.) and from an altitude of 25,000 ft. will have a velocity of 1400 ft./sec. at impact and the impact angle will be about the same. These impact velocities will not be attained in practice owing to air resistance, and, inasmuch as the air resistance increases with velocity, a balance between increase in velocity due to higher altitudes of release and decrease in velocity due to increased air resistance is reached. This theoretical maximum velocity for a given size and shape of bomb is called the **TERMINAL VELOCITY**; it is really a function of a given design, depending upon the aerodynamic characteristics of a bomb, rather than the practical velocity actually obtained, which we call the **IMPACT VELOCITY**.

A streamlined bomb contour results in a higher terminal velocity than a non-streamlined or spherical contour. A heavy bomb has a

greater terminal velocity than a lighter-weight bomb of the same size and shape. A lightweight bomb of poor ballistic shape represents about the worst condition and may have a terminal velocity of only 300 ft./sec. This velocity, however, might be the optimum one for incendiary bombs where penetration is not desired, and other factors like ease of clustering might require poor ballistic shape and light weight. The terminal velocity of our modern cylindrical bombs of the general-purpose type approaches the speed of sound, about 1100 ft./sec. Armor-piercing bombs, which are somewhat more streamlined than general-purpose bombs, may have a terminal velocity as high as 1500 ft./sec.

3. Types of Bombing.

With the general relationships between speed of the plane, altitude of release, velocity, and angle of impact in mind, we may now discuss the general types of bombing, particularly from the standpoint of bomb and bomb-fuze design. Although all types of bombing are now carried out with greatly improved accuracy, the development of very low-level bombing had as its objective greater safety of the plane, and in general the accuracy improves with lower altitudes of release. Of course, once the plane passes out of the treetop safety level into the level where anti-aircraft fire becomes effective, then the higher the altitude the greater the safety.

High-Altitude Bombing. Bombing at 10,000-ft. altitude and higher is usually called high-level or high-altitude bombing. The bomb is released while the plane is flying horizontally and high over the target area and several thousand feet from the specific target. The bomb impacts with its axis approaching the vertical at a fairly high impact velocity, so that considerable penetration of even fairly resistant targets results. For ordinary high-level bombing the impact velocity will be between 800 and 1100 ft./sec. and the impact angle about 20° from the vertical.

The bomb case may break up against resistant targets like steel plate or reinforced concrete, but against normal soil, frame buildings, and concrete of the thickness of slabs used in building construction, penetration will be obtained without damage to the bomb. Fuzes for bombs for high-level bombing are set for instantaneous action or short delay up to 0.10 sec. so that burst may be obtained on the surface or after penetration. Few secondary impacts are obtained against flat targets like highways and railroad yards, so that most of the stress is taken by the nose of the bomb, and the bomb body, tail fuze, and fin assembly receive few blows perpendicular to the bomb axis. Against multistoried buildings, however, secondary impacts may be obtained.

Medium-Altitude Bombing. This term is a relative one but connotes bombing performed at about the 5000-ft. altitude. The same general conditions apply to this type of bombing as to high-level bombing except that, for a given plane speed, say 400 ft./sec., the theoretical impact velocity would be decreased from 900 ft./sec. at 10,000-ft. altitude of release to 700 ft./sec. at 5000-ft. altitude of release, and the impact angle would increase from 27° to 35° from the vertical. Therefore there is less penetration for the same type of target and there are more side stresses in the bomb body and fuzes, but these changes are not sufficient to warrant any alteration in the general design.

Minimum-Altitude Bombing. Minimum-altitude bombing is really very low-level bombing, performed at treetop level, as low as 50 ft. off the ground or as low as the local conditions will permit. The purpose of such bombing is to obtain maximum accuracy by placing the bomb directly on a visible target only a few feet away. It has the further advantage of safety, both because of surprise and because antiaircraft fire is difficult to initiate under these conditions. Such bombing is variously called skip, masthead, and hedge-hopping bombing. The velocity of impact is little more than the speed of the plane since the height of drop is so small that little increase in velocity due to the acceleration of gravity takes place, and the angle of impact may be as high as 80° from the vertical. Secondary impacts are almost inevitable, and a bomb may bounce higher than the plane which dropped it, then hit the side of a building, tail end first, then smash against a steel girder sideways, and finally detonate, even though the bomb may be battered out of shape. Tail fuzes must be so designed that, even after the arming stem is completely broken off, the fuze will function correctly.

Instantaneous shots are not permissible in skip bombing because of the danger to the plane, and fuzes must be designed accordingly. Inasmuch as several seconds may elapse from the instant of first impact until secondary impacts have taken place and the bomb has finally come to rest, and since even without secondary impacts a delay of several seconds before detonation is desirable so that the plane will have time to move out of the dangerous zone, fuzes for skip bombing must be specially designed. Although bombs do not have to withstand the setback forces of artillery, they are subjected to very great and unpredictable forces from every direction, especially when secondary impacts are obtained from low-level bombing.

Dive Bombing. In this type of bombing, which preceded skip bombing and is an effort to improve accuracy, the plane dives at high speed, making a steep dive directly at the target, then releases the bomb and pulls out of the dive immediately. The velocity of the bomb is exactly

that of the velocity of the plane at the instant of release, which will be a higher velocity than that of bombs dropped in skip bombing because the dive speed of the plane is greater than the horizontal speed. The angle of impact is approximately the same as the angle of dive, and secondary impacts are quite possible. However, because the plane alters its course after release, it is not over the bomb at the instant of detonation, and dive bombing is done with standard fuzes.

Glide Bombing. This is not so much a technique of bombing as it is a method of bomb construction and operation. A bomb is fitted with wings and other control equipment and released from a plane at high altitude. It then glides into its target at a fixed glide angle, say 10° , the object being to release the bomb at a safe distance from the target. Released at 20,000-ft. altitude, the bomb would travel about 20 miles before impact.

New Bombing Techniques. Many new bombing techniques have been developed requiring new types of aircraft ammunition, but they will not be discussed at any length in this treatise. They include clear-weather control bombing in which the bomb is controlled in azimuth only, or both azimuth and range; bad-weather bombing in which an unseen target is reproduced on a screen by radio; and controlled glide bombing. The clear-weather work requires a 1-million-candlepower flare burning for the duration of flight in order that the control may be executed by watching the bomb to see how far off course it is, and then adjusting to bring it back on course. This control is a new and complicated field of study.

4. Bomb Detonation.

When a bomb detonates, a detonating wave is formed which travels at the speed of the rate of detonation of the explosive, say about 25,000 ft./sec., and which causes the bomb case to burst because of the high pressure created. According to one theory of bursting, the case expands one-quarter to one and a half times the original diameter and upon bursting breaks up into many thousands of fragments, mostly between $\frac{1}{4}$ and 8 oz. in weight, but with some dust and some very large pieces. The fragments are propelled outwardly at the same velocity as the wave front, but the velocity of the fragments falls off rapidly and the diameter over which the fragments are effective depends, of course, on such factors as the thickness of the bomb case, amount of explosive filler, and position of detonation.

The detonation is accompanied by a flash or flame front ahead of the expanding gases, but the flame front itself decreases rapidly with distance and disappears 40 to 50 diameters away from the detonation.

Most of the damage from a bomb bursting above ground is done by the tremendous blast wave created by the impact of the expanding explosive gases on the surrounding air. This blast pressure rises very rapidly, almost instantaneously, to the maximum value, then decreases to a pressure below atmospheric pressure, and then slowly rises to atmospheric pressure. These changes are shown in a general way in Fig. 100, in which the time duration of the pressure phase is denoted t_1 and that of the suction phase as t_2 . The pressure wave has the interesting property of not passing completely around corners without some deterioration, whereas the suction phase will turn corners, enter buildings, etc. The reflection of the blast wave from hard surfaces accounts in part for the breakage of windows in almost periodic variation down a street and for the fact that confinement augments the damage done. Most damage to personnel is done by fragments, flying debris, etc., rather than by the blast effect, unless such personnel are victims of a direct hit or a near miss.

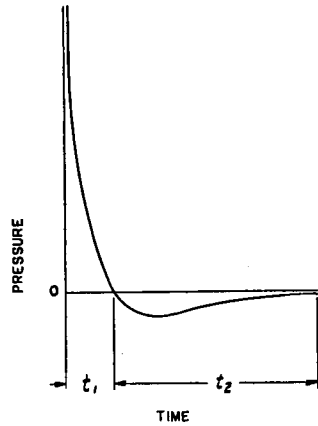

FIG. 100. Variation of blast pressure vs. time for detonation of demolition bombs.

High-capacity bombs and blockbusters cause most of their damage by explosive force. Some damage is also caused by earth shock induced by the detonations of such large high-capacity bombs.

5. Impact Conditions and Penetration.

The principal requirement of a bomb is that it shall hold together at impact until after the desired penetration has taken place, and not scatter its contents in the meantime. Of course, the amount of penetration depends upon the resistance of the impact surface; in order to give an idea of their relative resistances, some of the common targets are arranged in Table 16 according to increasing resistance. In general, standard 100-, 250-, and 500-lb. GP bombs are directed against the first eight items, 1000-lb. GP and SAP bombs against items 9 and 10, and 2000-lb. GP and AP bombs against items 10 and 11. The table at the end of Chapter 9 lists specific targets with the exact fuzing required.

Bombs dropped from high and medium altitudes will penetrate normal soil to a considerable degree. A 500-lb. bomb might penetrate 11 ft. in sandstone, 14 ft. in sand or gravel, 16 ft. in chalk, 20 ft. in clay; when dropped against a normal frame building, the same bomb might pene-

trate up to seven stories before coming to rest, provided that it did not hit a major structural element like a beam, girder, or column.

Thus it is seen that a bomb, particularly a large one traveling at high velocity, will do a lot of damage even before it detonates, because it causes damage structurally by generally messing things up, either by passing through buildings and structures before impact with the ground or by secondary impacts after first impacting the ground. The action is somewhat similar to that produced by a solid armor-piercing artillery shot after it has entered a tank, causing damage not because of the detonation of explosives but because it bounces around inside the tank at high velocity, damaging equipment and injuring or killing personnel.

TABLE 16

COMMON TARGETS ARRANGED ACCORDING TO INCREASING RESISTANCE

1. Light wooden structures such as roofs.
2. Tile and slate roofs.
3. Wooden floors.
4. Concrete roofs.
5. Concrete floors.
6. Ordinary soil.
7. Stone or gravel ballast and hard clay dirt roads.
8. Thin steel decks.
9. Concrete foundations and roads; medium steel decks.
10. Massive reinforced concrete.
11. Heavy and armored steel decks and roofs.

Bombs do more damage after some penetration than they do if detonated in the open, except possibly for the very large high-capacity blockbusters of 4000 lb. and larger which cover a greater area in the open than a normal size building. But, even so, such large blast-effect bombs can never really demolish a concrete structure or produce large craters in the ground and thus undermine military objectives because their case breaks up before any penetration can be achieved. The amount of penetration obtained and desired, then, is a matter of the target, and each type of target is best attacked with a certain type of bomb fuzed with a certain type of fuze.

6. Bomb-Design Formulas.

Bombs are usually designed on a strictly empirical basis, inasmuch as design formulas have not been developed to fit the actual conditions. Since most of the formulas worked out are based on many assumptions, designs based thereon require considerable checking by actual testing. Nevertheless, there are a few formulas of a very general nature which

will be of interest to the bomb designer. Although GP bombs may be made from either forgings, seamless tubing, or sections welded together, most modern bombs are of the welded construction. A carbon-manganese steel of about 70,000 lb./sq. in. yield strength and 105,000 lb./sq. in. tensile strength is usual, though some manufacturers choose a chrome or molybdenum steel to meet the required physical properties. The determination of the thickness of the walls of the bomb body including the nose and tail is a cut-and-try process. Existing designs are usually studied, and the wall thicknesses of the new bombs are determined by a careful consideration of the new requirements. Experimental bombs are made and tested and the design is corrected. The application of rigorous mathematical formulas takes so long that the bomb designer is usually better off to work empirically.

At this point we will list the symbols employed in discussing the design of aircraft ammunition as follows:

- H = altitude of drop, feet.
- V = impact velocity, feet per second.
- j = distance in which bomb is decelerated, feet.
- R = constant deceleration rate at impact, feet per second per second.
- F = total decelerating force causing deceleration of R , pounds.
- W = total weight of loaded and fuzed bomb, pounds.
- M = setforward ratio, pounds per pound.
- T = tangential stress on bomb walls due to setforward of filler, pounds per square inch.
- P = internal pressure due to filler, pounds per square inch.
- t = thickness of bomb case in cylindrical portion, inches.
- d = inside diameter of bomb throughout cylindrical portion, inches.
- W_e = total weight of explosive in bomb, exclusive of nose, pounds.
- D = outside diameter of bomb, cylindrical portion, inches.
- C = longitudinal compressive stress in bomb walls due to setforward of bomb, pounds per square inch.
- W_m = weight of metal back of nose, pounds.
- S = shear stress on bomb walls due to combination of T and C , pounds per square inch.
- A = distance between center of gravity of bomb and center of form, measured in same unit as B .
- B = overall length of bomb and fin assembly.
- ρ_m = density of bomb filler, pounds per cubic inch.
- ρ_c = density of bomb case material, pounds per cubic inch.
- N = percentage of total weight that is filler, expressed as a number.

L = length of cylindrical portion of bomb body, inches.

p = test hydrostatic pressure, pounds per square inch.

s = tensile stress on bomb walls due to test hydrostatic pressure, pounds per square inch.

α = specific volume of bomb as a whole, cubic inches per pound.

W_c = weight of cylindrical portion of bomb, both metal and explosives, pounds.

Nose Design. The usual proportions for the nose of a modern cylindrical GP bomb are shown in Fig. 101. The radius at springing is the radius from a center on a line perpendicular to the bomb axis at the

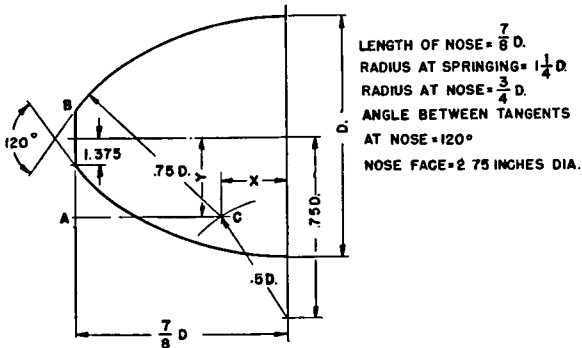

FIG. 101. Bomb-nose design.

nose end of the cylindrical portion of the bomb. The diameter at the nose will vary a little from 2.75 inches, depending on the size of the bomb. Most bombs are proportioned about as shown in Fig. 101. The thickness of the nose varies to a maximum near the fuze cavity and is determined by a layout on the drafting board. The 500 lb. bomb, for example, has a wall thickness of $\frac{5}{16}$ inch at the cylindrical portion which increases to about 1.3 inches near the nose opening.

With reference to Fig. 101, the coordinates of the point C , denoted by x and y , are related to the other dimensions by the equations

$$(0.5D)^2 - (0.75D - y)^2 = x^2$$

$$(0.75D)^2 - (0.875D - x)^2 = (y + 1.375)^2$$

By solving these two equations simultaneously for y , we have the equation

$$y^2(5.3125D^2 + 8.25D + 7.5625) + y(-4.9219D^3 - 0.6016D^2 + 5.6719D + 10.3984) + 0.9690D^4 - 0.4136D^2 + 3.59 = 0$$

Solving this equation by means of the usual form for a quadratic, it is found that, for D less than 9.6 in., y is imaginary, so that the proportions shown in Fig. 101 do not apply to small bombs. Of course, using a flat nose diameter less than 2.75 in. will aid in the solution.

The weight of the nose may be estimated for a bomb of outside diameter D in., inside diameter of cylindrical portion d in., thickness of wall of cylindrical portion of t in., by the empirical formula

$$\text{Weight of nose (lb.)} = 0.0012D^3 + 0.052 \frac{t}{d} D^4 + 11 \quad (28)$$

For the 500-lb. GP bomb, for which $D = 14$, $t = 0.34$, and $d = 13.32$,

$$\text{Weight of nose} = 0.0012(14)^3 + 0.052 \frac{0.34}{13.32} (14)^4 + 11 = 65.2 \text{ lb.}$$

Since, by actual calculation, the weight of the nose of the modern cylindrical 500-lb. bomb is known to be about 80 lb., equation 28 is only approximate.

The weight of the explosive in the nose may be estimated from the equation

$$\text{Weight of nose explosive (lb.)} = 0.0236D^3 - 0.0131 \frac{t}{d} D^4 \quad (29)$$

For the 500-lb. bomb, this equation gives the weight as 52 lb.

Suspension Lugs. The suspension lugs for GP bombs weighing 1000 lb. and less are 14 in. apart, and for bombs weighing 2000 lb. and more they are 30 in. apart. They are spaced equidistant from the center of gravity and tested at ten times the bomb load. Of course, as a plane banks and turns, the lugs are subjected to other types and magnitudes of forces and the lugs are tested in a centrifugal device at a force equal to several times the bomb weight. For suspension in dive bombers, one lug is provided.

Fin Design. The fin surface controls the bomb in flight. Modern bombs have four fins equally spaced, and their width is a little greater than the diagonal of a square inclosing the greatest diameter of the bomb. The fin area and thickness are determined by trial from such considerations as the stability factor, terminal velocity, overall length of bomb, and strength required to withstand dropping from high altitudes, say up to 40,000 ft. The fin assembly is an important part of the bomb round and must be accurately manufactured. Care must be taken that it does not become bent or distorted, and braces are added to stiffen the structure and prevent vibration.

The STABILITY of a bomb is a complicated matter like the stability of an artillery projectile, and this aspect of bomb design has received

considerable attention. However, for the purpose of bomb design, a rough approximation of stability may be made by considering the distance between the actual center of gravity and a point called the center of form, this being the center of gravity of the projected lateral surface, as shown in Fig. 102. We define the approximate stability factor as A/B , where A is the distance between the center of gravity and the center of form, and B is the total length of the bomb. The center of gravity will lie ahead of the center of form and also ahead of the center of pressure which enters into the derivation of the real stability factor but not the approximate one A/B . In fact, there is no relationship between the

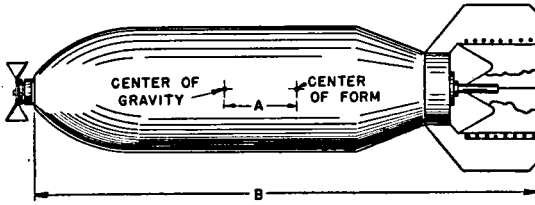

FIG. 102. Approximation of stability of bomb from center of form.

center of form and the center of pressure. The value of A/B should be between 0.16 and 0.23 for good design, and a value of 0.20 is desirable.

Setforward. Let us examine more closely the conditions at impact. If a bomb is dropped from an altitude of H ft., it will have a velocity of V ft./sec. at the instant of impact, and will then be decelerated very suddenly and brought to rest. Even if the impact surface is very hard, like concrete or steel, the deceleration will be accomplished while the bomb is traveling some finite distance, however small. Denoting this distance by f ft., we can write

$$V = \sqrt{2gH} = \sqrt{2Rf} \quad (30)$$

where R is the deceleration in feet per second per second, which we will consider constant. It is not constant, because the force resisting the motion of the bomb is not constant, but we will make this assumption, as is often done in artillery setback analysis. Then

$$gH = Rf$$

and

$$\frac{R}{g} = \frac{H}{f}$$

If F is the total decelerating force which causes the deceleration R , then, since $F = WR/g$ for a weight of bomb W lb.,

$$\frac{F}{W} = \frac{H}{f}$$

or

$$\frac{\text{Total decelerating force}}{\text{Weight of bomb}} = \frac{\text{Height of drop}}{\text{Deceleration distance}} = M \quad (31)$$

where M is defined as the setforward ratio, analogous to the setback ratio in artillery ammunition design. It is expressed in pounds per pound or pounds per grain, or simply as so many g 's, because Mg is the actual deceleration. The setforward force is equal to the mass of the bomb W/g times the actual deceleration, which is the setforward ratio times g , or Mg . The setforward force is therefore $(W/g)Mg = WM$.

A bomb body is really a cylinder, and the walls are subjected to a tangential stress at setforward due to the filler pushing outward against the walls, and to a longitudinal compression due to the weight of metal, and these forces may be combined as a resultant shear stress, which in turn can be related to the setforward ratio M . The maximum stress probably exists just to the rear of the nose in the side walls. The formula connecting internal pressure and tangential stress of cylinders is

$$T = \frac{dP}{2t} \quad (32)$$

Since

$$P = \frac{\text{Force}}{\text{Area}} = \frac{MW_e}{(\pi/4)(D - 2t)^2} \quad (33)$$

and

$$d = (D - 2t) \quad (34)$$

then, substituting equations 33 and 34 in 32,

$$T = \frac{2MW_e}{\pi t(D - 2t)} \quad (35)$$

The longitudinal compression is

$$C = \frac{\text{Force}}{\text{Area}} = \frac{MW_m}{\pi(D - t)t} \quad (36)$$

Combining 35 and 36 by means of the formula $S = \frac{1}{2}(C + T)$,

$$S = \frac{M}{2\pi t} \left[\frac{W_m}{D - t} + \frac{2W_e}{D - 2t} \right] \quad (37)$$

or

$$M = \frac{2\pi t S}{\frac{W_m}{D - t} + \frac{2W_e}{D - 2t}} \quad (38)$$

The maximum setforward ratio for any bomb can be computed by substituting in formula 38 the maximum value of S , and the values of t , D , W_m , and W_e . For the 500-lb. M64 GP bomb, $t = 0.34$ in., $D = 14$ in., $W_m = 135$ lb., $W_e = 200$ lb. (all approximate), and assuming that $S = 50,000$ lb./sq. in.

$$M = \frac{2\pi(0.34 \times 50,000)}{\frac{135}{13.66} + \frac{2 \times 200}{13.34}} = 2680 \text{ lb./lb.}$$

The setforward ratio varies as the weight of the bomb, because larger bombs will penetrate a given surface to a greater depth, and the setforward ratio will therefore be less. The standard surface for drop-testing bombs is the reinforced concrete "hard surface" at Aberdeen Proving Ground, which consists of 2 ft. of concrete with suitable ballast. It is desirable that bombs be drop-safe against such a surface from a fairly high distance, say 2000 ft. DROP SAFETY may be defined as the maximum height of drop for a given bomb on a given surface without causing the bomb to fail or without detonation. The first definition is used herein, and we can compute the relationship between W and M , where M is the setforward ratio which corresponds to a value of shear strength of the material. If this value of shear is taken as 50,000 lb./sq. in., then the relationship may be expressed by the empirical formula

$$M = 1000 + \frac{16,000}{\sqrt{7.5 + W/3} - 1} \quad (39)$$

which gives values of M for different weights of bombs, W , for a value of $S = 50,000$ lb./sq. in. This formula is empirical and is based on information obtained by dropping bombs of known design on the older concrete hard surface at Aberdeen Proving Ground. The new surface, constructed in 1940, will give higher values of setforward because it is more resistant. By using formulas 38 and 39, the designer can get a very good idea of what setforward any design will withstand without exceeding a particular value of shear.

Let us compare a 100-lb. GP bomb with a 95-lb. artillery projectile. In Art. 11, Chapter 6, it is shown that the setback ratio is 8400 for the projectile. For the bomb, computation gives a value of $M = 3960$ from equation 38 and $M = 4010$ from equation 39, so that bomb setforward is only about half of the projectile setback for equal weight. Of course, bombs constructed of steel having a higher maximum shear stress (above 50,000 lb./sq. in.) will withstand more setforward before failure. The

setforward ratio for large bombs is much smaller, being about 1600 for the 2000-lb. bomb.

Relationship between Volume, Weight, and Capacity. A relationship between the capacity of the bomb and the densities of the case and filler may be useful in determining the volume of a bomb of given weight.

Let

ρ_m = density of bomb filler, pounds per cubic inch.

ρ_c = density of bomb-case material, pounds per cubic inch.

N = percentage of total weight that is filler, expressed as a number.

α = cubic inches per pound of bomb as a whole.

Then, on a unit weight basis, the volume of the case is $1/\rho_c$ and the volume of the filler is $1/\rho_m$. Since the case weighs $1 - N/100$ and the filler $N/100$ of the total weight, we have

$$\begin{aligned}\alpha &= \frac{1}{\rho_c} \left[1 - \frac{N}{100} \right] + \frac{1}{\rho_m} \frac{N}{100} \\ &= \frac{1}{\rho_c} + \frac{N}{100} \left[\frac{1}{\rho_m} - \frac{1}{\rho_c} \right]\end{aligned}\quad (40)$$

For TNT and steel, this reduces to

$$\alpha = 3.533 + 0.142N \quad (41)$$

and Table 17 may be constructed. Other tables for different fillers may easily be constructed; they allow the designer to know immediately the total volume of a bomb of any weight and percentage capacity by knowing the densities of the filler and case materials.

TABLE 17

VALUES OF α FOR EQUATION 41

$N\%$	<i>Cubic Inches per Pound</i>
30	7.78
50	10.62
80	14.87

The density of loading can be determined by weighing the bomb when filled with water, then emptying the water and loading the bomb with explosive, and weighing. The increase in weight from the water to explosive can easily be converted into density of explosive, because the volume of water gives the volume of explosive. Bombs are "water weighed" to check loading conditions, density, cavitation, etc.

Body Design. The weight of the body including the tail cone, but not including nose or rear cap, may be estimated from the empirical formula

$$\text{Weight of body (lb.)} = 0.8891D^3 \frac{L}{D} \cdot \frac{t}{d} \left(1 - \frac{t}{D}\right) \quad (42)$$

where L is the length of the cylindrical portion of the body. For the 500-lb. GP bomb, $L = 24.9$.

$$\text{Weight of body} = \frac{0.8891(14)^3 24.9(0.34)}{14(13.3)} \left(1 - \frac{0.34}{14}\right) = 108 \text{ lb.}$$

Actual calculation for the same bomb gives 103 lb. for the body.

In preliminary design work, the total weight of the bomb is known and after subtracting the weight of the nose, obtained from calculation or empirically by equation 28, and subtracting also the weight of the tail cone from calculation, and the weight of the accessories and fin assembly, the weight of the cylindrical portion of the bomb W_c may be obtained. W_c may be expressed by the formula

$$\begin{aligned} W_c &= \text{Volume} \times \text{Density (for both metal and explosive portions)} \\ &= \left[\rho_m \frac{\pi}{4} [D^2 - (D - 2t)^2] + \rho_c \frac{\pi}{4} (D - 2t)^2 \right] L \end{aligned} \quad (43)$$

which reduces to

$$W_c = \left[\rho_m \pi (D - t)t + \rho_c \frac{\pi}{4} (D - 2t)^2 \right] L$$

or

$$L = \frac{W_c}{\rho_m \pi (D - t)t + \rho_c (\pi/4)(D - 2t)^2} \quad (44)$$

where L is the length of the cylindrical portion, which can now be computed by estimating W_c . For steel and TNT, equation 44 reduces to

$$L = \frac{W_c}{0.889(D - t)t + 0.045(D - 2t)^2} \quad (45)$$

The length of GP bombs of cylindrical design is usually four to six times the diameter.

7. Bomb-Design Tests.

During the course of the development of a bomb, the designer may make certain tests in order to determine whether it will satisfy the

tactical requirements. Many of these tests are repeated for testing fuze designs.

Fragmentation Tests. Bombs may be subjected to a FRAGMENTATION TEST in a sandpit like the test for artillery-shell fragmentation. Fragmentation bombs and GP bombs may be fragmented by placing them in a wooden box, burying in sand, functioning the fuze with an electric squib, and recovering the fragments that are retained on a No. 4 sieve, which are then segregated into the same weight groups as for artillery shell. A percentage recovery of 80–90 is average.

Low Panel Tests. The purpose of the so-called LOW PANEL TEST is to determine the number and distribution of fragments at different distances from the bomb. It includes the element of distance which the fragmentation test does not include. Four cylindrical quadrants of wooden boards or panels surround the bomb, which is detonated statically. Quadrants are at distances of 10, 20, 30, and 40 meters from the bomb, and are divided into panels, each panel being 12 in. wide, $5\frac{3}{4}$ ft. high, and $\frac{7}{8}$ in. thick, to simulate the size of a man. The number of fragments passing through these panels at the various distances gives a measure of the effect of bomb fragments at different distances, and an arbitrary method of scoring gives a panel test figure for comparison with other designs.

Silhouette Tests. In the SILHOUETTE TEST a bomb is dropped into the center of a series of wooden boards or panels arranged in open rectangular information, 15 by 45 ft., and the number of fragments passing through the panels is determined. The panels are the same size as in the low panel test. Corrections are made for impact at other than the exact center of the formation. This test is more nearly comparable to actual conditions as the impact velocity of the bomb is added to the detonation velocity of the fragments.

High Panel Test. The HIGH PANEL TEST is a static test in which a bomb is detonated in front of a steel plate set in concrete. This test is indicative of the power of the bomb as well as fragmentation because frames of vertical panels are set in front of the bomb and at distances of 50, 75, or 150 ft., depending on the bomb size, and several blast meters are set up 50 ft. from the bomb to measure the blast effect. The number and size of perforations in the panels and the blast-meter readings are recorded, and scoring is by an arbitrary method on a comparative basis.

Functioning Test. A test of actual FUNCTIONING under specified conditions is the best indication of bomb performance; it is both a development and an acceptance test. By this method, such elements of the design as fuze functioning, explosive train continuity, loading materials and methods, and even some elements of the mechanical design are

tested. The functioning test is usually conducted by dropping the bomb on normal soil from an altitude varying from 1500 to 3000 ft., depending on size. Of course such things as drop safety must be determined by a special test.

Crater Test. GP bombs are sometimes tested to determine the CRATER SIZE produced under certain conditions, which is a measure of the power of demolition effect of the bomb. The diameter of the crater and the depth or volume are considered good indices. For penetration in sandy soil of TNT-loaded bombs of cylindrical design the following empirical formula gives the crater diameter in feet:

$$\text{Crater diameter (ft.)} = \sqrt[3]{\text{Weight of explosive}} \quad (46)$$

Thus, a 100-lb. GP bomb with 50 lb. of TNT should give a crater diameter of 20 ft. An empirical formula for the volume of the crater in cubic yards is given by

$$\text{Volume (cu. yd.)} = 0.153 (\text{Weight of explosive}) \quad (47)$$

which applies to 500- and 1000-lb. bombs. For the 500-lb. bomb, formula 47 gives the size of the crater as 38 cu. yd.

Fragment Velocity. The VELOCITY OF FRAGMENTS is sometimes determined by a ballistic pendulum designed to catch fragments so that they can be weighed and their velocity can be estimated from the pendulum swing after the effect of blast is deducted. The velocity has been estimated at 2000 to 9000 ft./sec. near the bomb.

Welding and General Strength Test. The specification requires that bombs of welded construction be examined either by radiographic methods such as x-rays or by hydrostatic methods to determine the quality of welding, because, whereas good welding is very satisfactory, poor welding will produce not only an unsatisfactory but an actually unsafe bomb. All bomb bodies must be subjected to hydrostatic tests as follows:

1. Elongation test, in which the bomb must show no evidence of rupture after its diameter has expanded to 104% of the original.

2. Rupture test, in which the bomb is ruptured by increasing the hydrostatic test pressure of p lb./sq. in. until rupture occurs, and the fiber stress of s lb./sq. in. calculated from the formula

$$s = \frac{pD}{2t} \quad (48)$$

where t is the wall thickness in inches and D is the outside diameter of the bomb in inches. The value of s so calculated must not exceed 80% of the

tensile strength of the steel. This allowance is made to compensate for impairment of strength due to welding and fabricating. Formula 48 is the same as 32 except that d has been replaced by D for convenience without much error for such thin sections as are encountered in bombs.

3. Hammer and pressure test, in which the bomb is hit with a hammer, particularly around the welds, after the internal pressure has been applied hydrostatically.

8. Nomenclature.

The standard series of bombs developed by the Army is designated by M numbers. The 500-lb. GP bomb is known as the M64A1, where the A1 suffix denotes a variation of the original M64 design. If used by both the Army and Navy, the M number is preceded by the prefix AN, e.g., AN-M64A1.

Bombs developed by the Navy are designated by a Mark or Mk number, followed by a Mod number suffix if necessary. For example, the 325-lb. depth bomb Mk 17, if modified, might be called Mk 17, Mod 1. If the bomb is used by both services, the AN prefix is added, e.g., AN-Mk 17.

Soon after World War I the Army developed a series of streamlined GP or demolition bombs known as Mk I series, and the same series of bombs with thinner and thicker cases was known as the Mk III and Mk II series, respectively. The sizes were 100, 300, 600, and 1100 lb.

Starting in 1930 the first line of cylindrical bombs was developed, ending in bombs of the same sizes but called the M30 series. Later the sizes were standardized as 100, 250, 500, 1000, and 2000 lb., and this series was denoted by larger M numbers. It is this series, modified to incorporate certain improvements, which is the standard AN series of GP bombs.

Experimental bombs are denoted by T numbers and E suffixes exactly the same as other ammunition.

Strictly speaking, the bomb M number applies to the bomb and fin assembly, and a separate series of numbers is assigned to components such as fuzes, boosters, bursters, and trunnion bands. In this text the AN prefix will be omitted from many of the descriptions, and the usual complete-round tables should be consulted for the latest correct nomenclature.

The usual abbreviations for the various types of bombs are as follows: GP (general purpose), AP (armor-piercing), SAP (semi-armor-piercing), LC (light-case, sometimes called high-capacity, HC), Frag. (fragmentation), and Chem. (chemical).

THE BOMB COMPLETE ROUND

9. Description.

A **BOMB** is a missile designed to be dropped from aircraft. A **BOMB COMPLETE ROUND** consists of all the material or parts required to drop the bomb once; it usually consists of:

- (a) Bomb body with filler, constituting the pay load.
- (b) Fin assembly, to stabilize the bomb in flight.
- (c) Fuze, or fuzes, to function the bomb at the proper moment.
- (d) Arming wire assembly, which determines whether the bomb is dropped armed or safe.
- (e) Parachute assembly, for fragmentation and certain GP bombs.

These components are usually assembled in the field just before the bomb is hoisted into the bomb bay of the aircraft, except for small fragmentation bombs. The fin assembly, fuzes, and arming wire assembly are thus shipped separately from each other, and separate from the bomb itself, which is shipped loaded with plugs in the fuze cavities and protecting shipping bands around the lugs. Sometimes the arming wire assembly is shipped with the fin assembly, both being inert, but the loaded fuzes are shipped and stored apart from the loaded bombs. This practice allows sensitive fuzes to be handled apart from large insensitive bombs right up until the moment of assembly, a minimum time before takeoff.

10. Components of Bomb Complete Round.

Figure 103 shows the principal parts of a GP bomb complete round. The **BODY** itself consists of an ogival **NOSE**, a cylindrical center portion, and a straight conical **TAIL**, all welded together to form a strong assembly. The **FIN ASSEMBLY** is made of light sheet metal and provides stability for the bomb in flight. The fin assembly consists of a **FIN SLEEVE** which fits over the tail of the bomb and is held in place by the **FIN LOCK NUT**. The actual **FIN BLADES** are riveted or welded to the fin sleeve, which, together with the supporting numbers, form a square box, with a clearance through the center for the tail fuze. **SUSPENSION LUGS** are usually welded or bolted to the bomb body for supporting the bomb in the bomb shackle in the plane. Such lugs may be attached to metal bands known as **SUSPENSION BANDS**, which are bolted around the bomb body. **TRUNNION BANDS** serve the same purpose when trunnion mounting is desired for dive bombing, as they are also bolted around the bomb body. **LIFTING LUGS** are usually welded or bolted to the body.

The **FUZE SEAT LINER** is a metal cup assembled in the nose of the bomb to act as a receptacle for the **NOSE FUZE**, which screws into it. Back

of the fuze seat liner is a plastic adapter which supports the NOSE AUXILIARY BOOSTER. The BASE PLATE in the rear of the bomb serves to close the rear conical section after loading; the TAIL ADAPTER BOOSTER

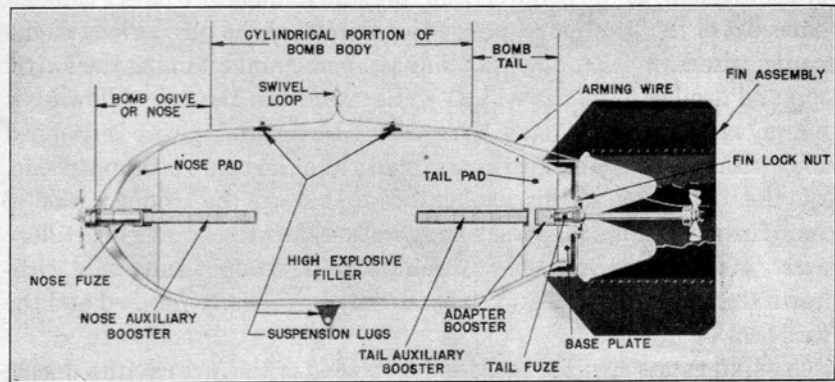

FIG. 103. Components of bomb complete round.

is screwed into it, and the fin lock nut screws over the base plate to hold the fin assembly. The TAIL FUZE screws into the adapter booster. Just after loading, while the FILLER is still mushy, the TAIL AUXILIARY BOOSTER is floated into position as shown.

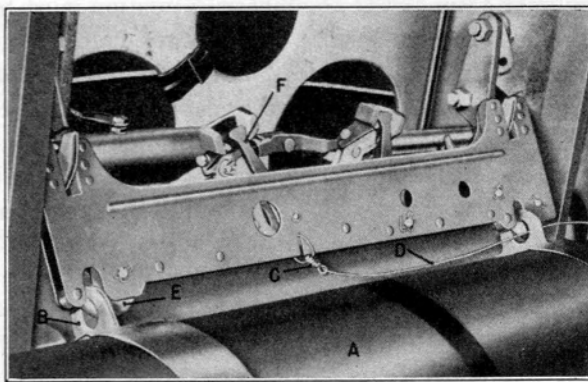

FIG. 104. Horizontal suspension of bomb in plane.

- | | |
|--------------------|------------------|
| A. Bomb. | D. Arming wire. |
| B. Suspension lug. | E. Bomb shackle. |
| C. Swivel loop. | F. Arming pawl. |

The ARMING WIRE ASSEMBLY consists of a length of brass wire with a swivel loop at one end and with one or more safety clips which can be easily moved along the wire, but which stay in position anywhere along

the wire as desired. The swivel loop may be in the middle of the wire if more than one fuze is to be used with it, but in any event it is fastened to the wire by a ferrule, as in Fig. 104. The swivel loop is fastened to the arming pawl of the bomb shackle, and the arming wire passes through some part of the bomb fuze, preventing arming of the fuze as long as the arming wire is in place. By dropping the bomb and retaining the swivel loop and arming wire, the wire is withdrawn from the fuze, allowing it to arm, as described in Art. 4, Chapter 9. If the arming wire is dropped along with the bomb, the fuzes cannot arm and the bomb is dropped safe. It is the withdrawal of this arming wire that starts the arming action of bomb fuzes, the same as setback and rotation start the arming of artillery fuzes. It is imperative that the arming wire be straight and easily withdrawn from the fuzes so that the bomb may be properly released and the fuzes arm.

CLOSING PLUGS are used to close the opening of the fuze cavities during shipping and storage.

Some types of bombs omit some of these components, and the differences will be discussed as we study the individual types of bombs.

11. Explosive Train.

The bomb complete round explosive train is very similar to the artillery high-explosive train except that special attention must be given to boosting because the high-explosive charge in a bomb is much larger than that in an artillery shell. An ordinary 2000-lb. GP bomb is 71 in. long and 23 in. in diameter, and the complete charge of 1061 lb. must detonate high order. For this reason, GP and LC bombs contain not only the regular fuze boosters but also auxiliary boosters, which are long tubes having the appearance of bursters. A typical explosive train for a GP bomb fuze with both nose and tail fuzes is shown in Fig. 105. The nose fuze is usually adjustable for either superquick or delay action, and the tail fuze, though not adjustable, may be fitted with primer-detonator elements of either the non-delay or delay types. The bomb bursting charge may be detonated by either the nose or tail explosive trains, depending on which train functions most quickly, which in turn depends on the actual delays of the two trains, the target, and the type of impact.

Fragmentation bombs and AP bombs do not have auxiliary boosters because the amount of explosive charge is much less. The fragmentation-bomb explosive train is very simple, consisting of a primer, detonator, and booster in the nose fuze ahead of the explosive charge itself. AP bombs

have a similar train except that it is contained in a tail fuze and a delay element and relay are added. SAP bombs are fuzeed exactly like AP bombs, but a tail auxiliary booster is added as the weight of explosive charge is intermediate between that of a GP and an AP bomb.

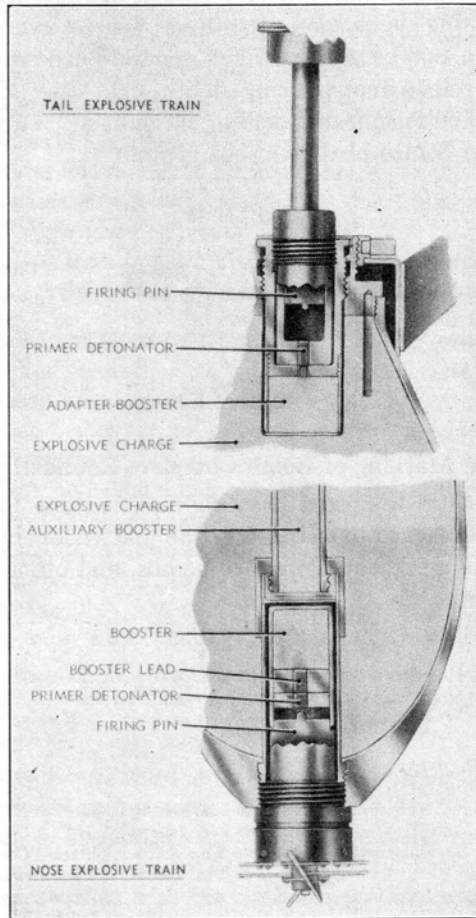

FIG. 105. Bomb explosive trains.

Chemical bombs other than incendiaries have an explosive train consisting of a primer and detonator, and usually a long burster throughout the length of the bomb, the bomb filler being other than explosive. The train is so designed that the action is similar to that obtained with chemical artillery shell, namely, that the case is broken open on the surface and the contents spilled out.

12. Sizes and Capacities.

The largest component of the bomb complete round is the bomb body, usually called a BOMB. Although defined as a missile dropped from an aircraft, it is actually a container for high explosive properly fuzed and boosted and designed to withstand certain impacts without breaking up, thus permitting detonation after some penetration. The principal types of modern bombs are known as general-purpose, fragmentation, armor-piercing, semi-armor-piercing, depth, light-case (sometimes called high-capacity), and chemical, including incendiary. Table 18 shows the sizes of standard bombs of the various types.

TABLE 18

GP	AP		SAP	LC	DEPTH	FRAG- MENTA- TION	CHEMICAL			PRAC- TICE
	M series	Mk series					Gas	Smoke	Incendiary	
100	600	1000	500	4000	325	4	100	10	4	3
250	800	1600	1000		350	20	115	100	6	4
500	1000				650	23	500		10	5
1000	1400				700	90	1000		100	20
2000						260			500	23
										100

13. Painting and Marking of Bomb Complete Rounds.

Table 19 indicates the usual painting and marking for bombs. The usual pattern is followed in that olive drab and yellow bombs mean live service bombs, blue indicates practice bombs, and other colors are used for chemical bombs.

TABLE 19

PAINTING AND MARKING COLORS OF BOMBS

Type of Bomb	Body Color	Color Bands on Body	Marking (Letters and Figures)
<i>High-explosive</i>			
(GP Demo., AP, SAP, Frag. *)			
Filled with TNT or amatol	Olive drab	Nose: One 1 in. yellow Tail: One 1 in. yellow	Black
Filled with Comp. B	Olive drab	Nose: Two 1 in. yellow Tail: Two 1 in. yellow	Black "Comp. B" stenciled on one nose band and one tail band
<i>Practice</i>			
<i>Drill</i>	Light blue	None	White
	Olive drab	Nose: One 1 in. black Tail: One 1 in. black	Black Drill (inert)
<i>Chemical</i>			
Non-persistent gas	Blue-gray	1 Green, nose, tail, and center	Green
Persistent gas	Blue-gray	2 Green, nose, tail, and center	Green
Irritant smoke (vomiting gas)	Blue-gray	1 Red, nose, tail, and center	Red
Screening smoke	Blue-gray	1 Yellow, nose, tail, and center	Yellow
Incendiary	Olive drab	1 Purple, nose, tail, and center	Purple

* Small fragmentation bombs: nose and tail painted yellow (no bands); body, olive drab.

14. Classifications.

Bomb complete rounds may be classified according to type of aircraft from which they are dropped, such as bombs for pursuit aviation or bombs for bombardment aviation. Since many bombs are dropped from a variety of aircraft, we will not classify them that way, but rather according to their service use, tactical use, filler, and capacity.

Classification according to Service Use.

1. Service bombs, for use against the enemy to do damage to matériel and personnel, regardless of the filler.
2. Practice bombs, for training of aircraft crews, especially bombardiers; have the same flight characteristics as service bombs, but usually are loaded with a spotting charge to give an indication of burst.
3. Drill bombs, to train ground crews in assembling, fuzing, unfuzing, and other handling of bombs, which are totally inert, and are not expendable.

Classification according to Tactical Use.

1. General-purpose bombs, for use primarily against matériel; cause damage by mining and general demolition after penetration.
2. Fragmentation bombs for use against personnel and light ground targets, because of their fragments rather than demolition effect.
3. Armor-piercing and semi-armor-piercing bombs, for use against resistant targets, where, for a given size bomb, demolition effect is sacrificed for greater penetration, although demolition effect is still the objective.
4. Chemical bombs, where proper dispersion of chemicals, smokes, or incendiaries is desired against personnel or inflammable targets.
5. Light-case bombs, where damage is done primarily to matériel by blast effect alone.
6. Depth bombs, for use against underwater targets, primarily by blast effect.

Classification according to the Actual Filler.

1. High-explosive bombs filled with suitable high explosives such as TNT, amatol, Composition B, and picratol.
2. Practice bombs, filled with a spotting charge of black powder or smoke mixture.
3. Chemical bombs filled with chemicals, smoke mixtures, incendiary mixtures, etc.
4. Miscellaneous bombs, filled with some special filler for a particular purpose.

Classification according to Capacity, or the Percentage of the Filler Weight to the Total Weight.

1. Low-capacity (less than 50%), such as AP bombs for which the capacity is 5-15%, and SAP for which the capacity is about 30%, and fragmentation bombs, 15%.
2. Medium-capacity (about 50%), such as GP bombs.
3. High-capacity (usually called light-case), (about 80%) such as the 4000-lb. blockbuster and depth bombs.

15. Explosive Capacity.

A distinguishing feature of bombs is the capacity of the bomb or the ratio of the weight of the filler to the total weight. A 50% capacity bomb is one for which the filler weighs half as much as the total weight. Table 20 shows the usual capacities of the various types of bombs.

TABLE 20

TYPE OF BOMB	CAPACITY PERCENTAGE OF TOTAL WEIGHT
AP (M series)	2-6
AP (Mk series)	14-16
Fragmentation	13-15
SAP	25-30
GP	50-55
Depth	70-75
LC	75-80
Chemical (gas and smoke)	30-80

With the exception of AP bombs, which have about the same capacity as AP shell, bombs have a much higher capacity than artillery projectiles, primarily because they do not have to withstand firing from a gun and therefore their cases may be light in weight compared to artillery projectiles.

The nominal weight of a bomb in pounds, which is usually a round number, may not be quite the exact weight of the loaded and fuzed bomb ready to drop, but it is usually within 10%. The ratio of the total length of a bomb to its diameter is also about the same for all bombs except those of the non-aimable type which are dropped only in clusters, the length being between four and six times the diameter.

16. Demolition and General-Purpose Bombs.

General. The bombs used during World War I were the 45- and 112-lb. so-called demolition bombs and the 25-lb. fragmentation bomb. A 230-lb. bomb was used to a very limited extent. Although no bombs of American design or manufacture were dropped in World War I, we had developed demolition bombs of 25-, 50-, and 100-lb. sizes. They were called DEMOLITION BOMBS because they did damage by explosive force against matériel.

After World War I it was decided to develop a series of demolition bombs of larger sizes in order to have available bombs of various weights effective against a variety of targets, and these bombs were patterned after the French streamlined "Gros Andreau" type. There resulted a series of streamlined demolition bombs known as the Mk I series in

sizes of 25, 50, 100, 300, 600, and 1100 lb., in addition to the 2000-lb. cylindrical bomb. These bombs were fabricated by welding and had an explosive capacity of about 50%. A Mk II series of these bombs with thicker cases and a Mk III series with thinner cases were developed and tested, but not adopted.

Since the art of welding had not progressed to the point where uniformity and reliability could be obtained, bombs were made experimentally of one-piece forgings, and during the period 1923-1936 the forging design was standard. However, it was decided that a cylindrical body having an ogival nose and a straight cone tail would be much more adaptable to mass production. The line of cylindrical demolition bombs in the M30 series in sizes of 100, 300, 600, 1100, and 2000 lb. resulted.

Up to this time consideration had been given to sizes of bombs for general-purpose use by both the Army and Navy with the idea of standardizing sizes and types. The sizes decided on were 100, 250, 500, 1000, and 2000 lb., and this series of bombs also designated by M numbers formed the basis of the present standard series of general-purpose bombs. They are for demolition work of all kinds, and although the cases are comparatively thin (about $\frac{5}{16}$ in. for the 250-lb. and $\frac{7}{16}$ in. for the 1000-lb. bombs), they will penetrate not too resistant targets before detonation. If functioned above ground, some additional damage will be done by the bomb fragments. For these reasons, they are called GENERAL-PURPOSE BOMBS instead of demolition bombs, or simply GP bombs, and they meet the demand of the majority of bombing situations. They are made either by welding or from forgings; the parts of a GP bomb complete round are shown in Fig. 106.

It is not possible to drop GP bombs safe against resistant targets like reinforced concrete and armor plate, because, not only will the bomb case break up and the charge detonate without fuzing action, but also the fuzes may function owing to the detonator or booster detonating by crushing and impact action. But GP bombs will achieve reasonable penetration with medium earth, ordinary buildings, and not too resistant structures with proper fuze action, and can be dropped safe on a hard surface at 4000 ft.

Explosive Filler. GP bombs are 50% capacity bombs, and when TNT was not plentiful 50/50 amatol was used as a filler along with TNT. For mass production, it is essential that the GP bomb be cast-loaded because of the large quantity of explosives involved, and 50/50 amatol can be cast and contains only 50% TNT. Of course, 50/50 amatol has a little less brisance than TNT, as stated in Chapter 2 on explosives.

The development of various RDX's made available another explosive for bomb loading capable of being easily manufactured in large quantities, namely RDX Composition B, called simply Comp. B. It has the advantages of higher brisance than TNT and is easily cast, though it is more sensitive than TNT. It is now a standard bomb filler along with TNT and amatol.

It is important that nose and tail pads or surrounds of TNT be used in amatol-loaded bombs to eliminate corrosive action which might

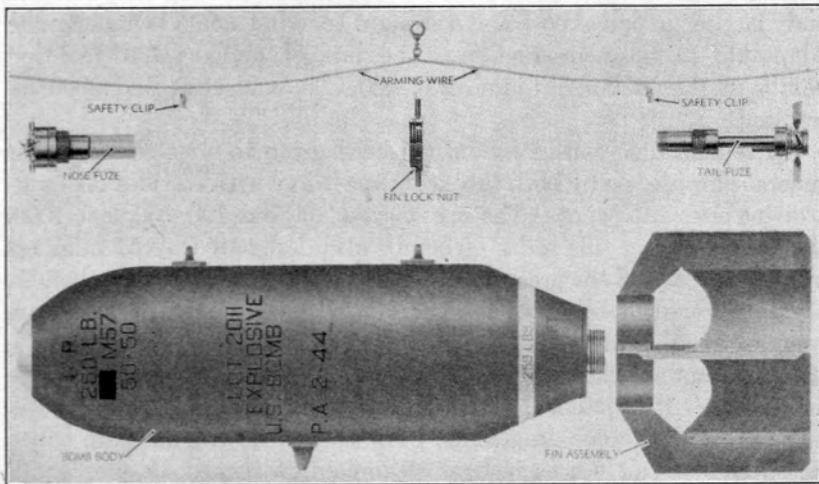

Fig. 106. GP bomb components.

occur around the fuze liners with amatol. Composition-B-loaded bombs also have nose and tail pads of TNT, because the greater sensitivity of Comp. B would reduce the drop safety of bombs. Recent tests indicate that even TNT does not have too much drop safety and that completely insensitive nose and tail pads of wax composition may be required, eliminating TNT surrounds with Comp. B loading.

Fuzing and Boosting. GP bombs are fuzed in both the nose and the tail, Fig. 107A; the double fuzing serves to give certainty and flexibility of functioning. It gives certainty because if both fuzes are dropped armed, as they usually are, a failure of one does not mean a dud as the other will function. It means flexibility because the two fuzes can be set for different delays, and then only the fuze with the desired delay may be dropped armed. Usually, however, the fuzes are set to function at about the same time, as, for example, a nose fuze set delay and the tail fuze set for a shorter delay, the inherent slower action of a tail fuze being taken

into account, or the nose fuze may be set superquick and the tail fuze set non-delay.

GP bombs may be fuzed only in the tail or dropped with only the tail fuze armed, if the type of action desired can be obtained only by a tail fuze, such as a delay of 4 sec. or more for low-altitude bombing. Such delays have as yet not been successfully incorporated in nose fuzes.

It is important to know what fuzes may be put in the various bombs, and for this purpose Table 21 is provided. The 100- and 250-lb. GP

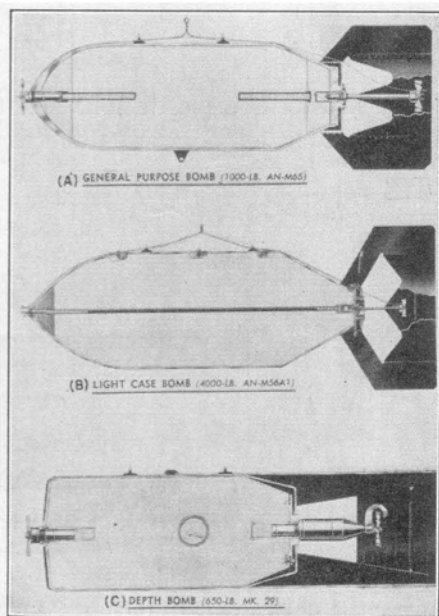

FIG. 107. Various bombs.

bombs take the M102 adapter booster, which screws into the base plate with 2-in.-diameter threads, and into which all 1½-in.-diameter tail fuzes will fit. Such fuzes include the M100, M112, M115, M123, and M132 series. The 500-, 1000-, and 2000-lb. bombs formerly fitted with the same M102 adapter booster are now fitted with the M115 adapter booster, which has 2½-in. threads where it screws into the base plate, and into which all 2-in.-diameter fuzes will fit. The AN-Mk 230 fuze for depth bombing of underwater craft and floating targets, and various experimental fuzes, fit in the M115 adapter booster. A bushing or sleeve is provided for the M115 adapter boosters so that all tail fuzes of 1½-in. diameter may also be used with it, as well as with the M102 adapter booster. All GP bombs have the same nose fuze cavity into which nose

fuzes, including the M103 type with 2-in.-diameter threads, may be screwed.

TABLE 21

RELATIONSHIP BETWEEN FUZES, ADAPTER BOOSTERS, AND GP BOMB SIZES

Bomb Size lb.	Auxiliary Booster	Adapter Booster	Diameter of Fuze Threads	
			Tail in.	Nose in.
100, 250	M104	M102	1½	2
500, 1000, 2000	M104	M115	1½ or 2	2
4000	M111	M115	1½ or 2	2

The M104 auxiliary booster is a plastic tube about 12 in. long and 1¼ in. in diameter containing tetryl pellets throughout its length. A

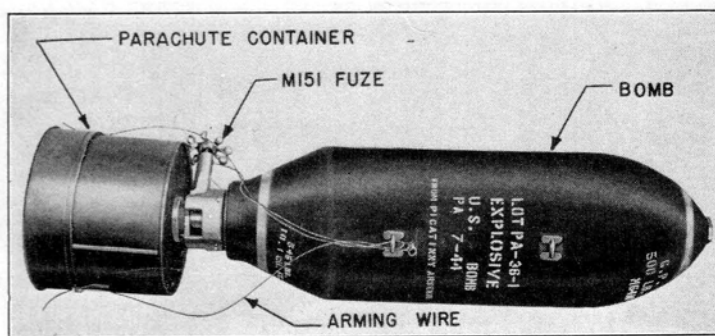

FIG. 108. 500-lb. GP bomb with parachute.

plastic sleeve fits over the enlarged end, forming a cavity in which the nose fuze seat liner fits, so that the M104 auxiliary booster in the nose end of the bomb is positioned directly under the fuze booster. When placed in the tail end of the bomb, the M104 auxiliary booster is "floated" without the sleeve in the bomb charge after the charge has been poured and has become mushy enough to keep the auxiliary booster in place. There is usually about ½ to 1 in. of space between the adapter booster and the auxiliary booster, as shown in Fig. 107A.

GP Parachute Bombs. In order to reduce ricochet and secondary impacts, GP bombs may be fitted with parachutes contained in a can attached to the tail of the bomb by means of an adapter. Removal of two arming wires from the side of the can allows the top to come off. A special fuze is required, since the can occupies the space usually taken by the tail fuze. Figure 108 shows a GP parachute bomb complete round.

17. Light-Case Bombs.

LIGHT-CASE BOMBS are cylindrical like GP bombs except that the case is extremely light, strong enough to withstand handling and shipping, but so weak that no penetration is possible because the case breaks up at impact. Such bombs are naturally of very high capacity, about 80%, and are fuzed for superquick or non-delay action. Since the purpose of such large bombs, popularly called BLOCKBUSTERS, is to damage large areas, particularly residential, by blast effect alone, functioning without penetration is essential, and this requirement is very consistent with the light-case construction. Such bombs obviously must be dropped from medium to high altitudes so that impact near the vertical is obtained. Skip bombing is prohibited because the light case will not withstand secondary impacts. Figure 107B shows a light-case bomb.

The fuzing and boosting system and fin assembly are the same as for GP bombs, except for the auxiliary booster. In order to insure high-order functioning of the $1\frac{1}{2}$ -ton explosive charge a special central M111 auxiliary booster of plastic about 84 in. long and $1\frac{1}{4}$ in. in diameter runs the entire length of the explosive charge. It is filled with tetryl pellets and has a sleeve at one end for positioning around the nose fuze seat liner. The tail end floats. Since tetryl at the densities generally used (1.5 to 1.6) has a little higher rate of detonation than TNT as cast, good high-order functioning should result. Nose and tail pads are of TNT.

The 4000-lb. bomb M56A1 is the only American blockbuster-type light-case bomb. It is 117 in. long and 48 in. in diameter across the fins. The British have dropped larger light-case bombs.

18. Fragmentation Bombs.

General. Against such targets as personnel, light ground targets, planes on the ground, etc., fragments are more effective than just blast effect, and fragmentation bombs satisfy this requirement. Although in general FRAGMENTATION BOMBS are smaller than GP bombs, the modern trend is towards larger ones, and bombs weighing as much as 800 lb. have been tried experimentally. The present line of standard fragmentation bombs includes bombs weighing 4, 20, 90, and 260 lb.; they are all low-capacity heavy-case bombs, the explosive not exceeding 15%. High capacity and blast effect have been sacrificed for fragmentation effect, and, since fragments under the ground are ineffective, surface burst is desired. The strength of the case is more than covered by the fragmentation requirement.

Fragmentation bombs are dropped from either medium or low altitudes so that good ballistic shape is not so important as in GP bombs.

The medium-level fragmentation bomb is equipped with stabilizing fins similar to those on GP bombs. For low-level work it is desirable to retard the forward motion of the bomb by a parachute so that the low-flying plane may pass quickly out of the danger zone. The parachute also provides for near vertical descent so that the bomb impacts nose end first, insuring not only uniform fuze functioning but also horizontal scattering of the fragments in all directions, with maximum

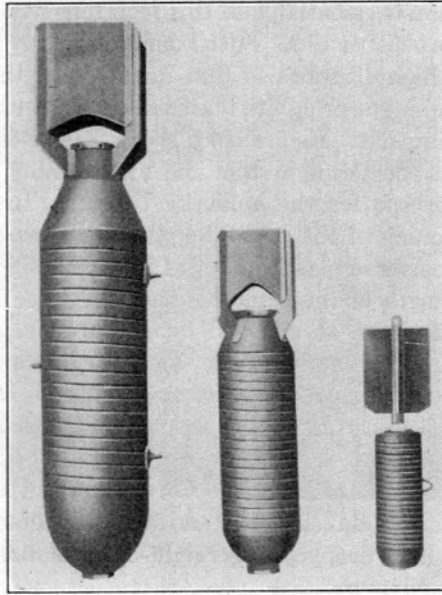

FIG. 109. Fragmentation bombs: 260-lb. M81, 90-lb. M82, 20-lb. M41.

fragmentation effect. The 20-, 90-, and 260-lb. bombs, Fig. 109, are made with fins for high-altitude dropping; the 20- and 90-lb. bombs are also fitted with parachutes for low-level dropping; the 4-lb. bomb is a special one for cluster dropping only and will be described separately.

Fragmentation bombs are loaded with TNT or Comp. B because high brisance is required to give the fragments maximum velocity and because a powerful explosive will partly compensate for the low explosive capacity. Even so, the size of the fragments is partially predetermined because the bomb body consists of a thin steel cylinder with heavy reinforced side walls of spirally wound steel bar or steel rings, the width of which determines the width of the fragments. A great many fragments may be put over an area by fragmentation bombs because a plane can carry a large quantity of the smaller bombs by clustering.

The parts of the high-altitude and parachute fragmentation bomb complete rounds are shown in Fig. 110.

High-Altitude Fragmentation Bombs. The three standard medium-altitude fragmentation bombs shown in Fig. 109 are the 90- and 260-lb.

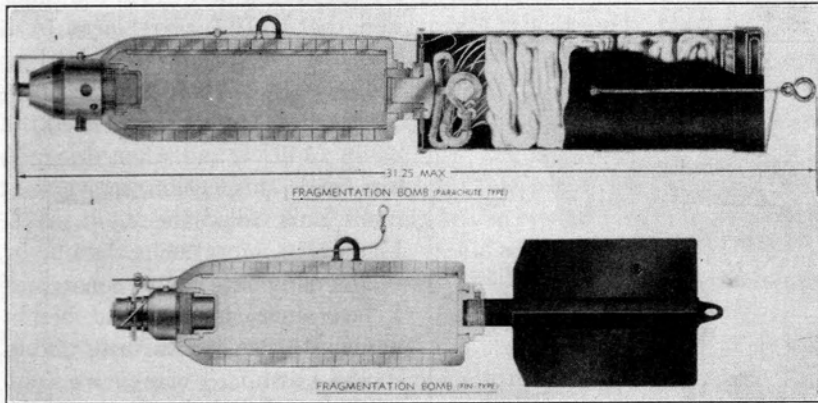

FIG. 110. Fragmentation bomb complete rounds.

bombs having box-type fins assembled in the field, and the 20-lb. bomb having a permanently attached four-bladed fin. The 20-lb. M41 bomb is fitted with the M110 superquick fuze, has lugs for either vertical or horizontal suspension, and is 21.8 in. long and 5.1 in. across fins.

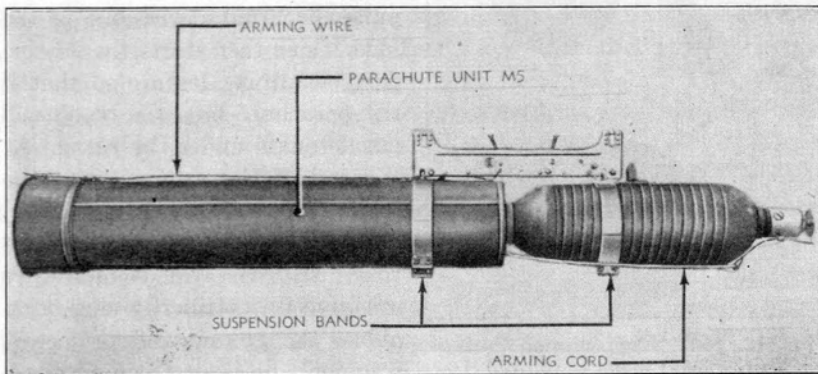

FIG. 111. 90-lb. fragmentation bomb with parachute.

The larger fragmentation bombs, 90-lb. M82 and 260-lb. bomb M81, look more like GP bombs and have GP bomb fuzes. They are also of the helix bar heavy-wall type but have heavy forged noses and tail cones and are effective against heavily resistant and concentrated targets such as

PT boats, light-armored motor vehicles, landing barges, large planes on the ground, and concentrated personnel. Other data on these bombs are given in the usual complete-round tables.

Low-Altitude Fragmentation Bombs. The 20-lb. bomb is used for low-altitude work with the fin assembly replaced by a parachute container

and the M110 fuze replaced by a semi-allways fuze of the M104 or M120 type. When designed particularly for clusters it is called the 23-lb. M40A1, and when designed for single suspension in vertical racks it is called the 23-lb. M72. Figure 110 shows such a bomb.

The parachute bomb consists of a nose fuze, helix-wound bomb, parachute can, parachute, and a special arming wire assembly. When the bomb is dropped, the end of the parachute can comes off and the parachute then opens because of its tendency to expand out of the can by the method of packing and the nature of the material. The opening up of the parachute pulls the arming wire out of the fuze, which then starts the 2.5-sec. delayed arming feature so that if the parachute fails the bomb will not detonate under the plane. At the end of the arming time, the bomb will be detonated by any light object, such as a branch of a tree, hitting the wide semi-allways sensitive fuze striker, giving burst above the ground and projecting fragments horizontally in all directions.



FIG. 112. 4-lb. fragmentation (butterfly) bomb.

The 90-lb. M82 fragmentation bomb may also be equipped with a parachute, as shown in Fig. 111. This bomb could have the M104 or M120 fuze with semi-allways feature, or a tail fuze set at right angles to the bomb axis and fitted with an anemometer vane for arming.

Four-Pound Fragmentation Bomb M83 (Butterfly Bomb). This is a small cylindrical bomb dropped only in clusters. It has a steel body and is filled with tetrytol, cast TNT, or RDX-A. The fuze screws into a cavity in the side of the bomb, and a cable extension projects from the fuze on which the butterfly wings are mounted. The wings, which really form a case around the bomb before it is dropped, open by spring action. They rise to the top of the cable (pigtail) and rotate, causing the cable extension to revolve and thus arm the fuzes. Three types of fuzes are available, combination air burst and impact, mechanical time delay of either 10, 20, or 30 minutes, and antidisturbance, known as the M129, M130, M131, respectively. This bomb, shown in Fig. 112, is primarily an antipersonnel fragmentation bomb for dropping in large quantities, and the three types of fuzes destroy morale as well as kill the enemy.

19. Depth Bombs.

DEPTH BOMBS are fairly large, high-capacity bombs of light-case construction for underwater demolition work, damage being done by the blast of the bomb and the hydrostatic pressure thus created. These bombs are fuzed with a nose fuze for instantaneous functioning against surface targets, and with transverse depth fuzes for use against submarines. If selective arming is not available in the plane, only the hydrostatic fuze is used. The effective radius under water is about 45 ft. for the 325-lb. bomb and 56 ft. for the 650-lb. bomb. Of course, these bombs are not suitable for penetration, and dropping from too high an altitude may not only warp the body but also cause the hydrostatic fuze to function at a depth much greater than for which set. The settings are usually made before takeoff. A typical depth bomb is shown in cross section in Fig. 107C.

Depth bombs are of Navy design, and they are available in 325-, 350-, 650-, and 700-lb. sizes. They have cylindrical bodies and flat noses to prevent ricochet on impact. The percentage of explosive is about the same as LC bombs, namely, about 75%.

The 350-lb. Mk 47 is the standard smaller depth bomb. It is 53.1 in. long, and the body is 15 in. in diameter. It contains 252 lb. of torpex, an aluminum explosive. When this bomb is loaded with 221 lb. of TNT it weighs 325 lb. and is called the Mk 41. It may also be loaded with Comp. B. These bombs take the Mk 219 nose fuze and the Mk 234 transverse hydrostatic fuze.

The 650-lb. Mk 29 is the standard large depth bomb, has a round nose, is 70 in. long, and may be fitted with a 72-lb. flat nose attachment. It contains 464 lb. TNT. When loaded with torpex it is called the Mk 49.

It is fitted with three fuzes: the M103 with special arming vane or the Mk 219 in the nose, the Mk 234 transverse hydrostatic fuze, and the Mk 229 hydrostatic tail fuze.

20. Armor-Piercing Bombs.

GP bombs are ineffective against resistant targets: concrete bomb-proofs, heavy ship deck armor, concrete structures, etc. In order to penetrate such targets ARMOR-PIERCING (AP) BOMBS have been developed. The walls and nose are of thick sections of high-strength steel, and explosive capacity has been sacrificed to accomplish penetration and perforation, the capacity varying from 5 to 15% of the total weight. The explosive is an insensitive one, such as D, and only tail fuzes are employed, as nose fuzes would be destroyed on impact and weaken the penetrating properties of the bomb. TNT is sometimes used and picratol shows great promise. AP bombs are somewhat more streamlined than GP bombs, and a direct hit is required, as even near misses are ineffective because of the small proportion of explosive.

This description sounds almost like the description of an AP artillery shell, and, in fact, the first AP bombs were converted artillery shell, with a tail fuze and adapter booster substituted for the artillery BD fuze, and lugs and a fin assembly added. Some sizes also have an AP cap on the nose. The present sizes of AP bombs of the converted artillery projectile type are 600, 800, 1000, and 1400 lb., have the M102 type tail fuze, usually set for delay, and are designated in the M series, as they are of Army design. A typical AP bomb is shown in Fig. 113B in cross section.

The Navy AP bombs are the 1000- and a 1600-lb. bomb, designated by the Mk series as shown in Fig. 113C. They are solid-nose, streamlined bombs, having base plug tail closures, but otherwise they resemble the M series of AP bomb. They are fitted with the Mk 228 tail fuze having a fixed delay of 0.08 sec., and they are used primarily against armored ships.

21. Semi-Armor-Piercing Bombs.

So-called SEMI-ARMOR-PIERCING BOMBS (SAP) are intermediate in design between AP bombs and GP bombs. They have cases heavier than GP and lighter than AP bombs, but they resemble GP bombs in shape, as shown in Fig. 113A. They are used for penetration of targets not quite as resistant as those penetrated by AP bombs, but against which GP bombs would be ineffective—lightly armored shipping, reinforced concrete, and similar targets. The capacity of SAP bombs is also between AP and GP bombs, being about 30%, and they are loaded

through the tail with TNT and 50/50 amatol, the usual TNT pads being used with amatol. Although the bombs are capable of being either nose or tail fuzeed, the nose adapter is usually filled with a plug and the tail fuze set delay used alone.

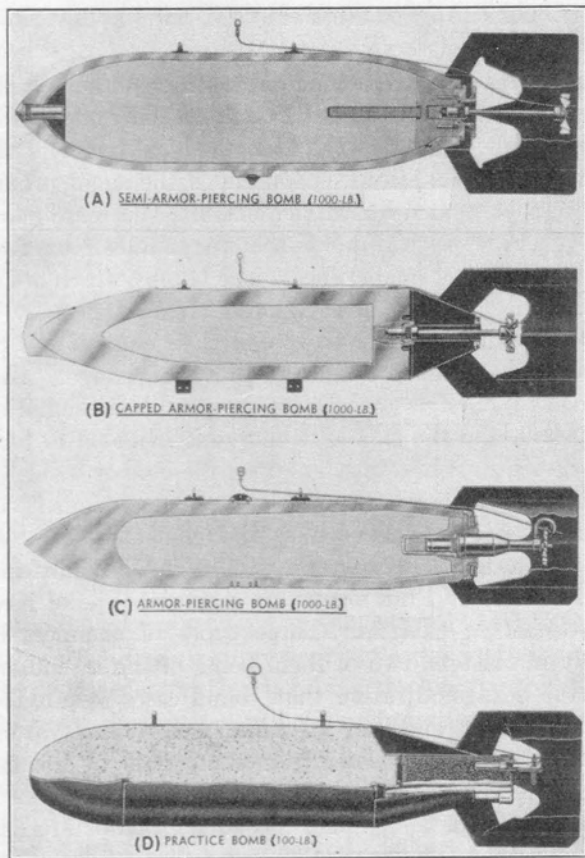

FIG. 113. Various bombs.

Whereas GP bombs do not require inert nose pads because they are not required to penetrate armor, and AP bombs do not require such a pad because of the thick section of steel at the nose and the fact that they are loaded with insensitive explosive D, SAP bombs do require some kind of inert nose pad, because they are required to penetrate some armor plate, have thinner nose sections than AP bombs, and are loaded with amatol or TNT. The wax pad is usually placed in the nose up to the level of the fuze; it consists of about one-third Kaolin, one-third rosin,

one-fifth petrolatum, and the balance of wax. Such a mixture has a melting point about the same as TNT, so that explosive can be cast on top of the pad.

The standard sizes of SAP bombs are 500 and 1000 lb. Data on them are given in the usual complete-round tables.

22. Chemical Bombs.

CHEMICAL BOMBS may be defined as those which have a main charge of a chemical agent. If this agent produces a toxic or irritant effect by means of chemicals, the bomb is a true chemical bomb; if the agent is smoke producing, it is a SMOKE BOMB, and if the agent produces an incendiary action, it is an INCENDIARY BOMB. The reason for grouping these three general types together is that they all have the same general construction, except the smaller incendiary bombs, which are dropped in clusters. Chemical bombs must function instantaneously above the surface of the ground in order to spread their charge. Of course, the bodies or containers must be tight to prevent leakage. These bombs are functioned by bursters (except for the smaller incendiaries), similar to chemical shell, and the explosive charge is adjusted to the nature of the contents, so that it may just lay open the case or just pulverize the contents without scattering them too far. Some chemical bombs have thin cases and do not have drop safety, though some of the recent chemical bombs, such as the M70, have cases similar to GP bombs and the same degree of drop safety. FIRE BOMBS are a special type of incendiary.

Bombs Released in Clusters. Three types of chemical bombs are dropped only in clusters, two of them being of the incendiary variety. All types have hexagonal rather than round cases to provide compact packing in the cluster, and they are functioned by integral inertia-type fuzes which are armed on release from the cluster by means of safety plungers held depressed against spring action by adjacent bombs in the cluster. Therefore these small incendiary bombs are dangerous if accidentally loosened from a cluster, and a drop of a few inches may ignite them.

Small incendiary bombs of the first type have cases of magnesium-alloy material, which are consumed as the bombs burn. They contain thermate composition which burns with an intense heat. Because such bombs burn in one place, they may be extinguished fairly easily by modern bomb fire-fighting methods; but an explosive element may be added to the bomb so that it explodes when only partly burned, thus scattering burning pieces over an area. This antipersonnel phenomenon greatly hampers fire fighting, because it is never known just when it will take place.

Small incendiary bombs of the second type have thin sheet-steel cases which do not burn but from which a jellied oil composition is ejected that burns intensely. The explosive feature may also be incorporated in this type of bomb. The present line of clustered incendiary bombs consists of a 4-lb. bomb of the straight incendiary-thermate type, both with and without the delayed explosive feature, and 6- and 10-lb. bombs of the incendiary oil type, both with and without the explosive feature.

The chemical bomb of the third type dropped only in clusters is a 10-lb. smoke bomb with hexagonal steel case.

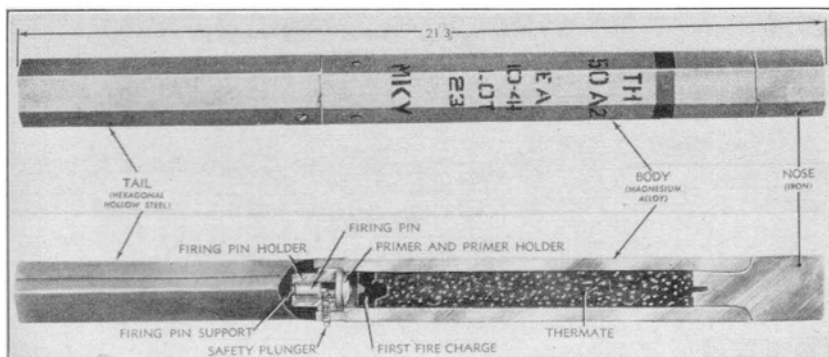

FIG. 114. M50A2 4-lb. incendiary bomb.

Larger incendiary bombs have been developed. The 100- and 500-lb. incendiary bombs fill the requirement for large incendiaries. A 2-lb. bomb might be satisfactory for bombing the highly incendiary targets of Asia, where too much penetration is undesirable.

1. Magnesium-case incendiary bombs. The 4-lb. incendiary bomb is made in two varieties, the M50A2, Fig. 114, of the straight incendiary type, and the M50XA3, Fig. 115, containing the antipersonnel explosive feature. The M50A2 is 21.3 in. long and 1.69 in. across the flats, weighs 3.7 lb., and contains 0.63 lb. of thermate composition in the magnesium body, which weighs 1.25 lb. The thermate burns about 1 min. and ignites the case which burns 4 to 6 min. after it becomes ignited.

The M50XA3 (the X suffix denotes presence of the antipersonnel feature) is a variation of the M50A2 in that a delay fuze of a few seconds to several minutes, a detonator, and a tetryl explosive charge have been added in the steel housing at the end of the bomb. The bomb fuze burns for about 1 min. and then the delay fuze is ignited. At the expiration of the delay the bomb detonates, projecting fragments of the steel shell and burning magnesium. The actual delay before detonation varies

depending upon the position that the bomb happens to assume after it lands, and the variable delay combined with the explosive feature is very discouraging to fire fighters.

2. Steel-case incendiary oil bombs. There are two 6-lb. incendiary oil bombs, the M69 without any antipersonnel feature and the M69X containing the detonating element. The M69 is 19.5 in. long and 2.9 in. across the flats; it has a charge of 2.8 lb. of gelled gasoline in a cheese-cloth sock and an ejector-igniter charge of 0.4 oz. of black powder and magnesium. The case is of sheet steel, and the incendiary oil composition is ejected from it. The incendiary oil composition or gelled gasoline,

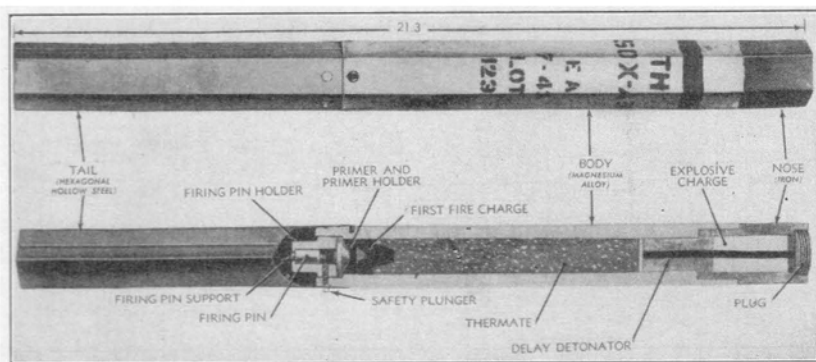

FIG. 115. M50XA3 4-lb. incendiary bomb.

as it is sometimes called, is formed by adding a powder to gasoline. The M69 bomb is stabilized by a group of muslin streamers contained in a tail cup. The fuze has a 3- to 5-sec. delay, after which the gel is ignited and ejected and then burns for 8 to 20 min., depending upon the size of the individual fragments. It is shown in Fig. 116.

The M69X bomb is similar except that a high-explosive charge is added in the nose and is ignited by a detonator after a delay of 1 to 6 min. obtained by Bickford fuse. Each bomb has a fixed delay, and the various delays are obtained by using different lengths of the fuse which is ignited by a flash from the ejection charge.

Two 10-lb. bombs similar to the M69 and M69X types have been developed, known as the M74 and M74X, respectively. They represent improvements over the M69 types in that the muslin streamer has been replaced by a six-bladed fixed shroud fin on the end of the tube which is spring ejected when the bomb is released from the cluster, thus giving more positive stabilization; the mixture of gelled gasoline has magnesium and oxidizing agents added to it to obtain a more intense burning material; and a container of WP smoke has been added to hinder fire

fighting further, the smoke making the bomb difficult to locate and extinguish. The M74X bomb therefore contains a comparatively large quantity of intense burning material combined with a delay explosive, antipersonnel feature, and obscuring smoke.

3. Smoke bombs. A small 10-lb. smoke bomb, known as the M77, has been developed with a hexagonal steel case for dropping in clusters similar to the incendiary types of about the same size. It is 19.5 in.

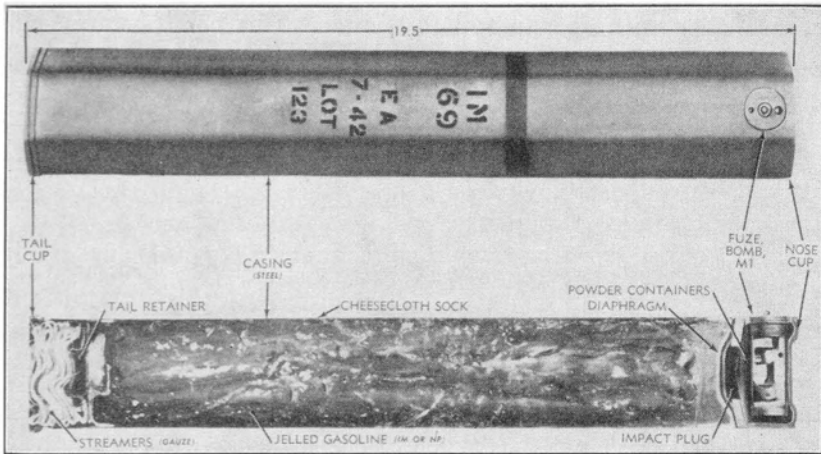

FIG. 116. M69 6-lb. incendiary bomb.

long and 2.9 in. in diameter and weighs 13 lb. It is functioned with an allways fuze which blows off the end of the case, and the HC smoke burns from one end for 12 to 15 min. Although a single bomb does not produce a very dense smoke cloud, a large number of them can screen a large area, and they have the advantage over a single larger smoke bomb that the smoke is spread over a larger area and "pillaring" is eliminated.

Bombs Released Individually. Chemical bombs of 100 lb. and larger are not clustered at the present time and are released individually in the same manner as GP and other bombs. Of course, two or more 100-lb. chemical bombs may be clustered the same as two 100-lb. GP bombs, as described in Art. 25. These chemical bombs have either thin cases or cases similar to those for GP bombs, and the tendency is toward GP bomb cases for both incendiary and smoke bombs.

These bombs released individually have ogival noses and tail fins; they are directed at point targets because they have better flight characteristics than the clustered incendiary. The fin assemblies are like those for GP bombs, being shipped assembled for the 100-lb. size and separately for the larger sizes. They are functioned by nose fuzes (and also

tail fuzes for larger sizes) and by a central burster running the length of the bomb. Components for the 115-lb. chemical bomb are shown in Fig. 117.

1. Chemical bombs. The 100-lb. M47A2 is the older-style thin-case chemical bomb with a variety of fillers, such as persistent gas H, white phosphorus WP, or incendiary composition. It is 49 in. long and $8\frac{1}{2}$ in. in diameter, is made of sheet steel coated on the inside with oil, and is functioned with the M126 SQ bomb fuze (formerly by the M108 fuze) in connection with an appropriate burster. This bomb has different

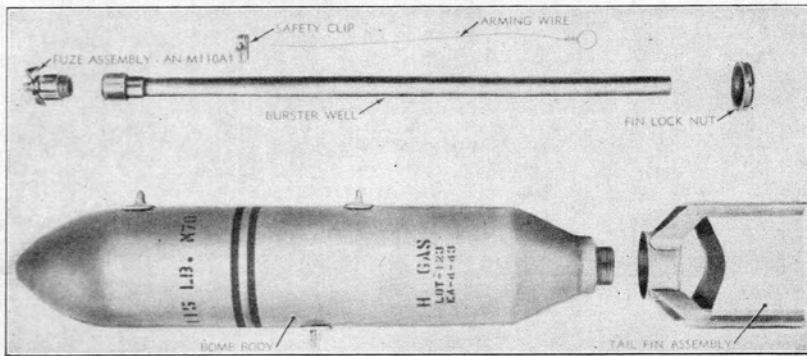

FIG. 117. M70 chemical bomb.

weights and percentage capacities depending on the filler. When the bomb is loaded with 68.5 lb. mustard gas (H), the total weight is 98 lb.; with 100 lb. WP, the total weight is 127 lb.; with 40 lb. of gelled gasoline (IM or NP), the total weight is 69 lb.

The 115-lb. M70 chemical bomb, as made from tubing, has an ogival nose and separate fin assembly, is 48.7 in. long and 11 in. across the fins, and weighs 116 lb. when filled with 51 lb. persistent gas (H). It is fuzed with the M110 fuze, as shown in Fig. 136.

Two large chemical bombs have also been designed from GP bombs by welding the base plate to the case and providing a burster well running the length of the bomb. A needle valve is assembled in the base of the bomb for collecting surveillance samples and for the relief of excess pressure. The 500-lb. M78 bomb may be filled with 170 lb. CK filler for a total weight of 450 lb., or 205 lb. phosgene with a total weight of 485 lb., or other suitable fillers. The 1000-lb. M79 is filled with 200 lb. AC, or with 340 lb. CC filler with a total weight of 860 lb., or with other suitable fillers. Both bombs use the M103 nose fuze set SQ, or the M127 if air burst is desired, and in the tail have the M101 or M102 set non-delay.

2. Incendiary bombs. The large incendiary bombs have been designed from GP bombs by modifying them for field assembly of burster and igniter. They are loaded with a gasoline gel-magnesium mixture, and they take the standard nose and tail fuzes of GP bombs, set instantaneous and non-delay, respectively. They may also be fuze with the M127 nose fuze for air burst by using the M117 adapter booster. The 500-lb. bomb M76 contains 180 lb. of mixture and weighs 475 lb.

FIRE BOMBS are made from converted auxiliary fuel tanks like those on fighter aircraft and in sizes from 75 to 300 gal. For minimum-altitude bombing no fins are added, but for medium-altitude bombing modified GP bomb fins are added for stabilization. An allways fuze with an anemometer vane which arms in about 100 ft. of air travel is attached to the tank with an adapter, and an igniter similar to the M15 WP grenade body ignites the composition. The igniter is filled with WP for land and sodium for water use. The composition is gelled gasoline similar to that in the M69 bomb, and the most popular size is the 165-gal. fire bomb which has a modified 2000-lb. GP bomb fin. Such a bomb will spread fire over a very large area and is very effective against Japanese targets.

23. Practice Bombs.

PRACTICE BOMBS are for training bomb crews in marksmanship. They must have the same flight characteristics as the service bombs they are intended to simulate, and if they look like service bombs they are painted with a light blue band at nose and tail for identification as practice bombs. These bombs may have a fuze which functions a spotting charge, or the spotting charge may be one that breaks upon impact to give a signal, the rest of the bomb being sand-loaded. The line of practice bombs consists of a miniature practice bomb weighing 3 to $4\frac{1}{2}$ lb., depending upon the body material; a low-altitude parachute practice bomb simulating the 23-lb. service fragmentation bomb; a practice fin-stabilized bomb simulating the 20-lb. high-altitude fragmentation bomb; and a 100-lb. practice bomb simulating the GP bomb.

The 3-lb. Mk 23, 3-lb. Mk 5-Mod 1, and the 4.5-lb. Mk 43 miniature practice bombs are all 8.25 in. long and 2.5 in. in diameter, and they have bodies of cast iron or other materials. They are functioned by a firing-pin assembly held in by a cotter pin. Upon impact the firing pin is pushed into the primer, firing the composition to give an indication of impact.

The 20-lb. M48 practice bomb is 21.8 in. long and weighs 19.7 lbs. The charge is 2 oz. black powder loaded through a hole in the side of the body closed with a sheet-metal disc.

The 17-lb. M37 parachute practice bomb simulates the 23-lb. M40 fragmentation bomb; being inert, it is safely handled by inexperienced personnel, and the parachute gives an indication of accuracy. It is used repeatedly as long as serviceable in planes with vertical or horizontal suspension. The 23-lb. M73 also simulates a fragmentation bomb for individual suspension without fuze or spotting charge. The 23-lb. M71A1 parachute practice bomb serves the same purpose for cluster suspension. Empty standard parachute bombs are now utilized for practice work.

The 100-lb. M38A2 practice bomb simulates GP bombs, is loaded with 80 lb. of sand, and has a tail spotting charge, shown in Fig. 113D. It has the same contour as GP bombs but a uniform wall thickness so that the bomb will break up on impact and minimize possible danger to personnel and matériel. The spotting charge—a 2.3-lb. mixture of hexachlorethane, magnesium powder, anthracene, and black powder—is fired by a firing pin riding forward on impact to fire a blank-loaded shotgun shell. A modified spotting charge is used with sonic spotting devices.

The 100-lb. M75 practice bomb is provided to furnish a target reference point for practice bombing on snow. It resembles the 100-lb. M47A2 chemical bomb, but is loaded with red iron ore which is disseminated by a high-explosive burster.

24. Shaped-Charge Bombs.

Although none of the standard bombs today employ the shaped-charge principle, some work has been done on applying it to the design of bombs. Because shaped charges are most effective when the axis of the charge is normal to the target at the time of functioning, and because bombs seldom hit the target exactly head on, there is some question whether shaped charges would be particularly effective in bombs. Then there is the matter of initiating the large bomb charge from the tail. The bomb case is probably not sufficiently strong to withstand impact without distortion until the time the inertia element of a tail fuze functions, and any distortion resulting in damage to or misalignment of the liner is harmful. With a nose fuze, the impulse would have to be transmitted through the center of the charge or around it down the inside of the case to the tail booster, and the nose fuze parts might interfere with jet action. Finally, shaped charges are most effective against resistant targets that it is desired to penetrate, and such targets tend to distort or break up bomb cases and nose fuzes. No doubt shaped-charge bombs will eventually be developed for specific purposes.

BOMB CLUSTERS**25. Purpose and Description.**

When aerial bombing first started, planes were designed to carry bombs at stations in the bomb bay (or under the wing), and each station was designed to carry a certain size bomb, the stations being identified as the 500-lb. station or the 1000-lb. station, etc. A bomb station is designed to handle a certain size bomb; as the carrying load of planes has increased the maximum size of bomb capable of being carried at a station has increased. Of course, all bombs having suspension lugs 14 in. apart (1000 lb. and under) can be carried in the same station, and all bombs having lugs 30 in. apart (2000 lb. and over) can be carried in the same station, but it is obviously a waste of airpower, men, and materials to carry small bombs at a station designed for larger bombs. A plane having ten 1000-lb. bomb stations would be operating at 10% efficiency, as far as bomb-carrying capacity is concerned, if it carried ten 100-lb. bombs in the ten stations, assuming that the target called for 100-lb. bombs.

To avoid this waste of carrying power where smaller bombs are required for tactical purpose, bombs may be assembled in **CLUSTERS**, which are groups of two or more bombs held together by a **CLUSTER ADAPTER**. The clusters are a convenient form in which to release bombs for area bombing, in contrast to point bombing, where it is desired to cover an area with bombs and the individual trajectories are not so important. Clusters which open up just after release simulate salvo bombing, and the cluster as a whole need not have good flight characteristics as it serves merely as a device for holding the bombs together, and releasing them at the proper time. As small fragmentation bombs required special bomb racks, either a given plane could be used for fragmentation bombs only, thus decreasing that plane's versatility, or the bomb racks had to be changed frequently. Another reason for clustering, then, is to permit the use of the same racks for all types of bombs.

Some clusters are designed to stay together for an appreciable time after release, and these delayed-opening clusters may be constructed about the same as quick-opening clusters, or they may have good flight characteristics so that their trajectories can be predetermined, and they are then called **AIMABLE CLUSTERS**. Sometimes aimable clusters are actually streamlined and have smooth exteriors, particularly when they are composed of very small bombs, as shown in Figs. 122, 123, and 126. Delayed-opening clusters have time fuzes for opening the cluster and dispersing the bombs at some predetermined time after release.

Clusters are designed so that they may be supported in the bomb bay with lugs exactly like individual bombs, and the weight of the cluster is usually somewhere near that of the single bomb that the cluster is

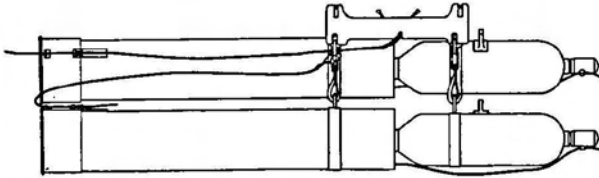

FIG. 118. Hook and cable type cluster of two 90-lb. fragmentation parachute bombs.

intended to replace. Thus, the cluster of six 20-lb. fragmentation bombs weighs 125 lb. and is intended to be carried in the 100-lb. bomb station.

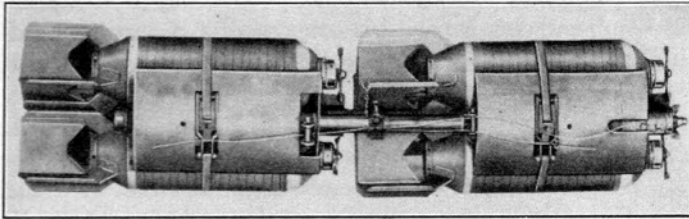

FIG. 119. Cluster of six 90-lb. fragmentation bombs.

The cluster of twenty 20-lb. fragmentation bombs weighs 465 lb. and is intended to be carried in the 500-lb. bomb station.

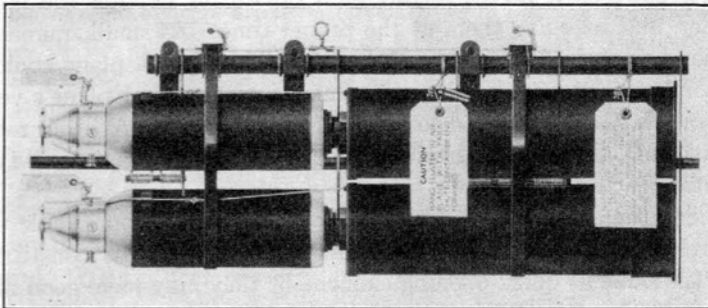

FIG. 120. Cluster of three 23-lb. fragmentation parachute bombs.

The tendency during World War II has been towards more and larger clusters, owing no doubt to the development of larger planes and the demand for area bombing. The 4-lb. M83 fragmentation and the 4-lb.

M50 incendiary bombs are the smallest bombs clustered, and the 100-lb. bomb is the largest one clustered, although clusters of two 250-lb., two 500-lb., and two 260-lb. have been considered. Figures 118, 119, and 120 show clusters of two 90-lb., six 90-lb., and three 23-lb. fragmentation bombs, respectively.

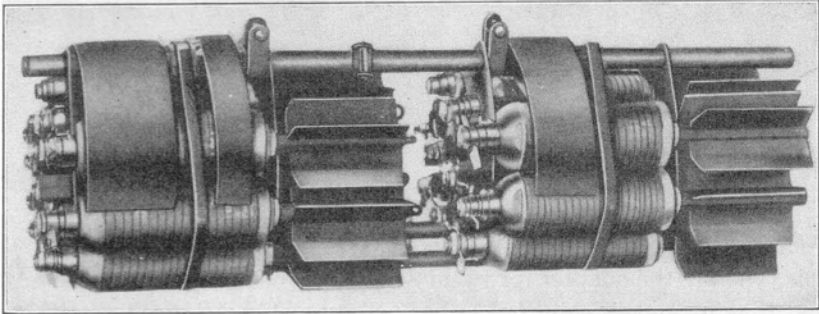

FIG. 121. Cluster of twenty 20-lb. fragmentation bombs.

26. Construction.

Cluster adapters usually consist of two or more longitudinal members for strength and rigidity, plus two or more cross members to hold the bombs in position, plus various straps or wires to fasten the bombs in the cluster and release them at the proper time. One of the longitudinal members contains lugs for both single and double suspension. Typical adapters of this type are shown in Figs. 121, 123, 124, 125, etc.

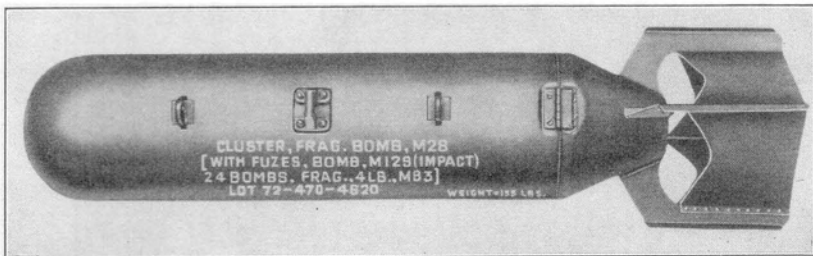

FIG. 122. Cluster of twenty-four 4-lb. butterfly bombs (adapter closed).

An entirely different type of cluster adapter is the totally enclosing type, consisting of a thin sheet-metal cylindrical case shaped like a GP bomb and fitted with hinges. Individual bombs are packed in the case, which obviously is of the aimable delayed-opening type, and when the case opens by fuze actions the bombs are released. Typical adapters of

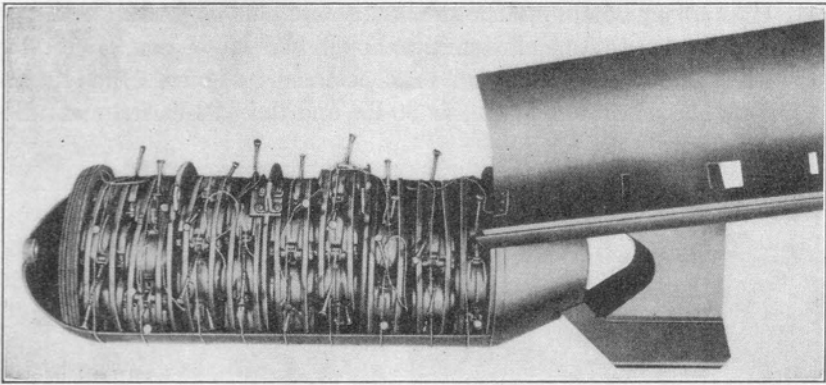

FIG. 123. Cluster of ninety 4-lb. butterfly bombs (adapter open).

this type are the adapter for twenty-four 4-lb. butterfly bombs (closed) and that for ninety 4-lb. butterfly bombs (open), shown, respectively, in Figs. 122 and 123.

Another type of totally enclosing aimable cluster, Fig. 126, consists of two semicylindrical metal sheets shaped like a GP bomb and held together with straps and release buckles which open by tail-fuze action. The fin assembly is blown off the cluster, causing arming wires to be withdrawn from the buckles and allowing the two halves of the body to

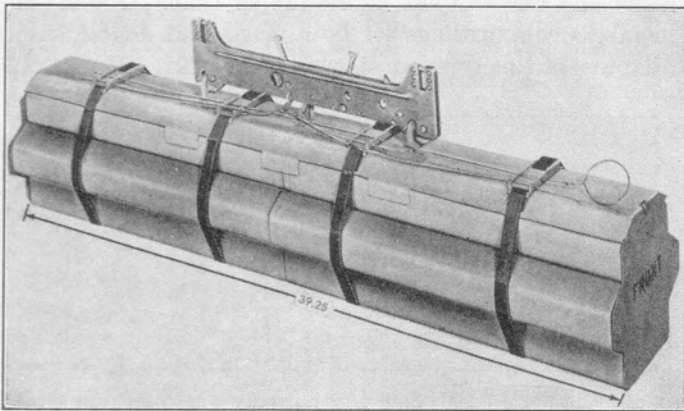

FIG. 124. Incendiary-type cluster of fourteen 6-lb. bombs.

fall away, releasing the individual bombs. Both the 6- and 10-lb. incendiary oil bombs are clustered this way, the 6-lb.-bomb clusters, one containing the M69 and the other containing the M69X bombs, being standardized as the M19 and M21 clusters, respectively.

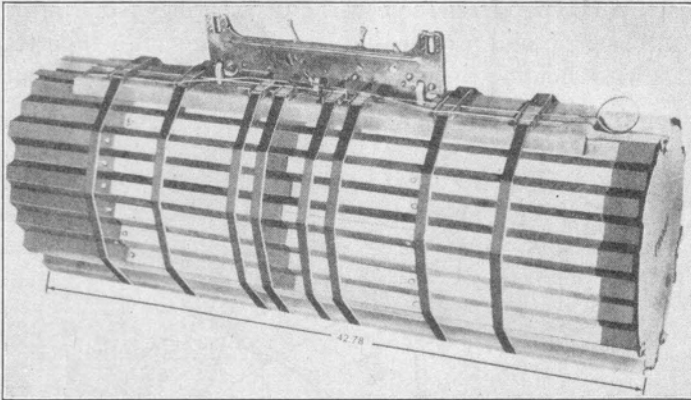

FIG. 125. Incendiary-type cluster of one hundred and twenty-eight 4-lb. bombs.

The RELEASE MECHANISM that causes the cluster to open may be one or a combination of several types, as follows:

- (a) Instantaneous mechanical.
- (b) Delay mechanical.
- (c) Instantaneous cartridge.
- (d) Delay fuze.

The mechanical release is functioned by withdrawal of the arming wire from a toggle-type clamp which holds the straps in place. This is usually an instantaneous release as the arming wire is withdrawn as the cluster leaves the bomb rack. Short-delay opening can be attained

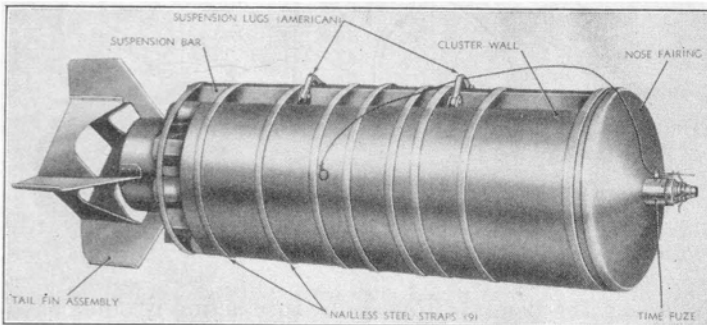

FIG. 126. Aimable cluster of incendiary bombs.

with this type of release by employing an arming flap which is lifted by the air stream, causing full release of the clustering bands; the cluster opens about 30 ft. under the plane. This mechanism is being considered for certain incendiary bomb clusters.

The cartridge type of release consists of a spring-loaded firing pin, a firing mechanism, and a steel slug to move through a tube through which pass wires holding the bombs. The steel slug shears or cuts the

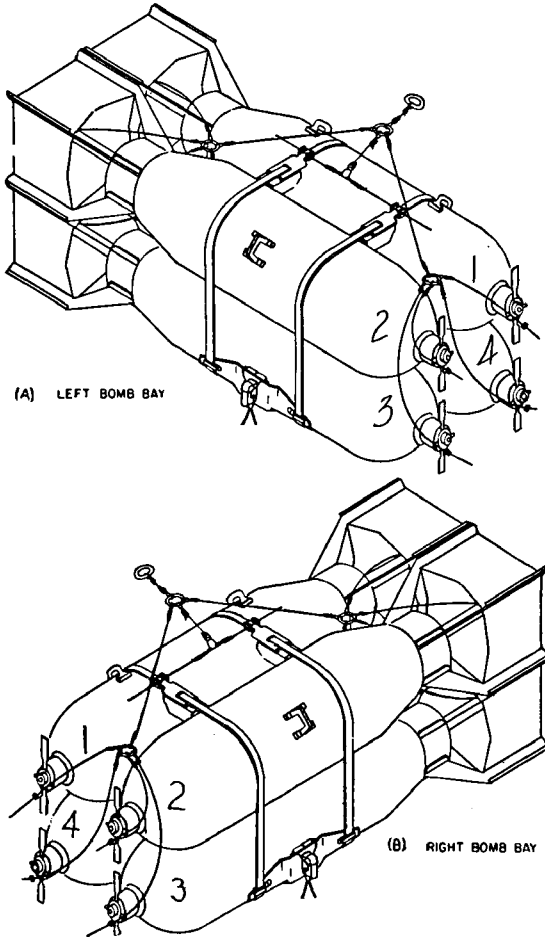

FIG. 127. Strap-type cluster of four 100-lb. GP bombs.

wires, releasing the bombs. Release by fuze action is obtained by the firing of the fuze after the cluster has fallen a predetermined distance.

The hook-and-cable cluster adapter is really a means of attaching two or more bombs to the same set of bomb shackles so that, instead of one bomb, several are released simultaneously. The individual bombs are not actually clustered, and the hook-and-cable (or strap) arrangement permits hanging two or more bombs where one is normally hung.

This arrangement of bombs is shown in Fig. 118 for two 90-lb. fragmentation parachute bombs and in Fig. 127 for four 100-lb. GP bombs.

27. Cluster Data.

Table 22 gives pertinent data on the more important clusters. The entire subject of clustering deserves much study, and many improvements in the ballistics, fuzing, and construction of clusters will no doubt be forthcoming.

TABLE 22
DATA ON BOMB CLUSTERS

Cluster No.	Cluster Adapter No.	Bomb Size lb.	Designation	No. of Bombs	Weight of Cluster lb.	Type of Release	Bomb Station
<i>Fragmentation Bomb Clusters</i>							
M1	M1	20	M41	6	125	Inst. cart.	100
M2	M1	20	M48 Prac.	6	125	Inst. cart.	100
M1A1	M1A2	20	M41	6	125	Inst. mech.	100
M2A1	M1A2	20	M48 Prac.	6	125	Inst. mech.	100
M1A2 same as M1A1 except bombs shipped unfuzed.							
M4	M3	23	M40	3	87.2	Inst. mech.	100
M4A1 same as M4 except bombs shipped unfuzed.							
M5	M3	23	M71	3	76	Inst. mech.	100
M26	M13	20	M41	20	500 *	{ Inst. mech. } { Fuze delay }	500
M27	M14	90	M82	6	585	Fuze delay	500
M28 *	M15	4	M83	24	155	Fuze delay	100
M29 *	M16	4	M83	90	441	Fuze delay	500
.....	90	M86	2	225 *	Inst. mech.	100
<i>Incendiary Bomb Clusters</i>							
AN-M6	M5	{ 4 4 }	{ M50A2 M50XA3 }	{ 28 6 }	145	Inst. mech.	100
M7	M6	{ 4 4 }	{ M50A2 M50XA3 }	{ 102 26 }	540	Inst. mech.	500
AN-M12	M4	6	AN-M69	14	105	Inst. mech.	100
AN-M13	M7	6	AN-M69	60	417	Inst. mech.	500
M17A1 *	M10A1	{ 4 4 }	{ M50A2 M50XA3 }	{ 88 22 }	500+	Fuze delay	500
M14	M10A1	4	M50A2	110	500+	Fuze delay	500
M19 *	M23	6	AN-M69	38	400+	Fuze delay	500
M21 *	M23	6	M69X	38	400+	Fuze delay	500
<i>GP Bomb Clusters</i>							
M12	Cable and hook	100	M30	2	200+	Inst. by release from shackle	100
	Strap	100	M30	4	400+	Inst. by release from shackle	500

* Aimable cluster

CHAPTER 9

BOMB FUZES

1. General.

A BOMB FUZE is a mechanism for igniting or detonating the explosive charge of a bomb; it performs the same functions at the target for the bomb that the artillery fuze performs for the artillery projectile. It tells the bomb what to do and how to do it. Bomb fuzes function in about the same way as artillery fuzes do, the main difference being in the method of arming; since neither setback nor rotation is present, these forces cannot be employed. In addition, no effort is made to streamline the contour of bomb fuzes. The nose of the bomb is large compared to the size of the fuze, and the fuze usually screws into a deep cavity so that little protrudes; tail fuzes fit into the fins so that streamlining is not a factor. Since the weight of the bomb is so large in proportion to the weight of the fuze, no effort is made to keep the weight of bomb fuzes low or to make the weight the same for all fuzes. Another factor influencing this decision is the fact that bombs are fuzed before takeoff, no changes being made in flight, and, since the downward trajectories are influenced but little by differences in bomb-fuze weights, ballistic interchangeability is not important, the proper fuze being selected before assembly into the bomb bay. Of course it is essential that all nose fuzes have the same threads and that all tail fuzes have the same threads for mechanical interchangeability.

The number of sizes and types of bomb fuzes required has increased as the number of sizes and types of bombs and the various bombing techniques have increased. The early nose bomb fuzes were merely firing mechanisms, the explosive elements being contained in the booster to which the firing mechanism was adapted. Between World War I and World War II a modern series of bomb fuzes was developed, consisting of one nose fuze for all GP bombs, three sizes of tail fuzes for GP bombs, but of the same construction and type of functioning, a simple fuze for chemical and smoke bombs, a simple fuze for high-altitude fragmentation bombs, and a fuze for low-altitude fragmentation bombs. It was intended that all GP bombing would be from medium to high altitudes, and such fuzes as long-delay, antisturbance, and air-burst types had

not been demanded by the Air Force or developed. Our repertory of bomb fuzes has increased from seven or eight to forty or fifty since 1941.

The system of nomenclature for bomb fuzes is the same as for bombs, and the complete-round table or the table of fuzes should be consulted for the proper prefixes and suffixes, and particularly to determine whether a fuze is standard for both services.

The formulas in Chapter 6 for artillery-fuze design may be applied to bomb-fuze design.

2. Bomb-Fuze Explosive Train.

The bomb **EXPLOSIVE TRAIN** was discussed in Art. 11; it will be treated here from the standpoint of the fuze. The parts of the bomb-fuze explosive train are exactly the same as for the artillery fuze; they may consist of a primer, delay, relay, detonator, and booster. Of course, the delay and relay may be omitted, and the primer and detonator may be combined. The **BOOSTER** may not be sufficient to guarantee high-order detonation of a large bomb charge several feet long, and so an **AUXILIARY BOOSTER** is required.

The nose bomb fuze usually has the booster built integral with the rest of the fuze, and the fuze screws as a unit into the nose fuze well. The tail bomb fuze usually does not have the booster integral with the fuze but contains elements of the explosive train up to and including the detonator. The tail fuze is screwed into an **ADAPTER** which contains the booster in its lower half, the combination being known as an **ADAPTER BOOSTER**. The explosive trains of nose and tail fuzes differ in another way, namely, that the explosive train of the nose fuze is predetermined by the designer and manufactured that way, whereas the explosive train of the tail fuze may be varied at the point of assembly. This variation is accomplished by providing a **PRIMER DETONATOR** assembly, containing the primer and detonator, and delay and relay if needed, which screws into the base of the tail fuze. These replaceable primer detonators are interchangeable so that delays of, say, 0, 0.01, 0.025, and 0.05 sec. may be obtained with the same tail fuze, and the decision does not have to be made until just before takeoff. Typical primer detonators are shown in Fig. 149.

3. General Construction of Bomb Fuzes.

Nose bomb fuzes usually consist of a striker head, firing pin, safety block, arming mechanism, and explosive elements all assembled permanently into the fuze body. The safety blocks are located under the striker head so that a direct load or force on the striker will not push

the firing pin into the primer. This action may also be prevented by passing the arming pin directly through the striker body. The striker of the arming-vane type of fuze may be restrained by blocks that are not released until the vane has completed a predetermined number of revolutions. Nose fuzes for GP bombs have $1\frac{1}{2}$ -in. or 2-in. threads, and although their weight is not standardized they all weigh from 2 to 4 lb. and are heavier than tail fuzes because of their integral boosters and because they must withstand direct impact on resistant targets.

Except for mechanical time and chemical fuzes, tail bomb fuzes consist of an inertia-type firing pin, arming mechanism, and a primer detonator unit, all assembled into the fuze body. The arming pin may pass directly through the plunger firing pin, or the arming stem of the vane type may be screwed into the firing pin, preventing firing-pin action until it is unscrewed. The firing pin may be either of the simple inertia type or of the cocked type. Cocked firing pins require the fuze and bomb to decelerate before they function, but, once they start to function, a spring drives the firing pin into the primer much quicker and with more force than may be obtained with the simple inertia type on light impact. The cocked firing pin allows the designer to make the fuze extremely sensitive so that little retardation is necessary before it functions, and it is this principle that allows fuzes to be dropped from low altitudes on water and light targets and still result in satisfactory performance.

Arming-vane tail fuzes are usually made in three lengths, depending on the size of the bomb, in order that the arming vane may be in the air stream. Larger bombs have fins that extend farther to the rear of the bomb, and it is necessary to have the tail fuze extend out near the end of the fins. The short length accommodates the 100- and 250-lb. bombs, the medium length the 500-lb. bomb, and the long length the 1000-lb. bomb and larger sizes. Tail fuzes of the arming-pin type do not vary in length with bomb size.

Plunger-type tail fuzes require creep springs, whereas nose fuzes do not because nose fuzes do not employ inertia-type firing-pin plungers. Some artillery point fuzes have inertia-type firing pins and require creep springs, but so far nose fuzes are not designed on this principle.

Hydrostatic fuzes work on the principle of a bellows or diaphragm which expands owing to increase in water pressure and thus counteracts the force exerted by a spring. When the spring force is overcome, the firing pin is released and driven against the primer by spring action, the action really being that of a cocked firing pin. Adjustment may be made by changing the springs of some designs, or by controlling the amount of compression of the diaphragm spring in others.

4. Bomb Fuze Arming.

General Description. Since centrifugal and setback forces are both absent, bomb-fuze ARMING cannot be accomplished by employing these forces as is done in artillery-fuze design, and some other method that will not complicate the simple scheme of releasing bombs suspended by one or two lugs is needed. For this purpose an ARMING WIRE is used, one end of which is threaded through some part of the bomb fuze and the other end of which contains a swivel loop fastened to the arming pawl of the bomb shackle. If it is desired to drop the fuze armed, the swivel loop is retained in the arming pawl, so that the arming wire is not dropped with the bomb, with the result that it is withdrawn from the fuze, thus starting the arming action. If it is desired to drop the fuze safe, the swivel loop is released from the arming pawl so that the arming wire is dropped with the bomb, with the result that it is not withdrawn from the fuze, and arming action is prevented. Of course, bombs having two fuzes need two arming wires so that the arming of each fuze may be controlled. Figure 104 shows the arming-wire arrangement.

Withdrawal of the arming wire initiates the arming action, which is accomplished by either the arming-pin or the arming-vane methods. In the arming-pin method, withdrawal of the arming wire allows the arming pin to be spring ejected, thus starting the arming action. In some designs ejection of the pin may itself constitute the complete arming. In the arming-vane method withdrawal of the arming wire allows the vane to rotate in the air stream, thus starting the arming action. In some fuzes only a very few turns of this vane are required to complete the arming, and in others hundreds of revolutions are required.

The arming mechanism is designed to arm the fuze in a definite time, depending upon how far below the plane it is desired that the fuze be armed. ARMING TIME may be expressed in seconds, feet of air travel, or drop in altitude. The arming time in seconds speaks for itself, being the time elapsing between dropping of the bomb (withdrawal of the arming wire) and completion of arming. It may be expressed in feet of air travel along the bomb trajectory, computed from the number of revolutions required for complete arming and the speed of rotation or determined experimentally in the wind tunnel for certain air speeds corresponding to bomb rates of fall. And it may be expressed in the altitude of drop, or the distance under the plane, measured on the vertical, which the bomb must fall before the fuze is completely armed.

The arming time depends on the tactical job; it is a balance between safety of the plane (long arming times) and altitude of drop (low altitudes require short arming times). Long arming times, say more than 500 ft. of air travel, were former practice because bombing was done from

medium to high altitudes. When the skip-bombing technique was developed in about 1942, the requirement for shorter arming times immediately arose; when bombs are dropped at such low levels the arming time is extremely short, the fuze being armed only a few feet under the plane.

Bomb-fuze arming may include the lining up of some element of the explosive train such as the detonator; such fuzes are **DETONATOR SAFE**, the principle being exactly the same as in artillery-fuze design. The exact arming process will be described in detail as we discuss typical fuzes.

Arming-Time Relationships. The arming time of a vane arming fuze depends on many factors, such as the speed of the plane when dropped; the density of the air, depending upon the altitude; the design of the arming vane, including diameter, pitch, and area; the gear reduction ratio; the number of threads engaging the arming stem with the plunger or other element; the contour of the bomb nose; and the design of the fin assembly in relation to the position of the vanes. This last factor brings in the size of the bomb, for a nose fuze on a small bomb may arm faster than the same fuze on a large bomb because more air passes near the fuze vane of a small bomb than of the larger bomb with a comparatively blunt nose.

The real criterion of arming time is the number of revolutions of the vane required to arm the fuze, and this number is independent of the bomb size, speed of the plane, etc., but is inherent in the design of the fuze itself and can therefore be calculated. Nevertheless, we must be interested in another criterion of arming time, namely, the number of feet of air travel required to arm the fuze; this criterion does bring into account all the other factors in addition to the actual fuze design. This air-travel distance, Fig. 128, is measured along the path of the trajectory,

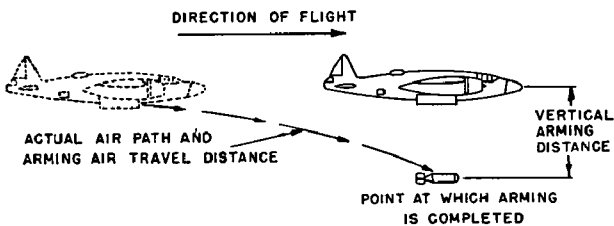

FIG. 128. Relationship between plane and fuze arming.

which is near the horizontal at the start of the trajectory, becoming more nearly vertical as the bomb drops and arming proceeds. Still a third criterion is drop in altitude required to arm the fuze, and it is related to air-travel distance. At the start a slight drop in altitude corresponds

to a large air-travel distance, but, as the trajectory becomes more nearly vertical, air travel and vertical travel correspond more closely.

The M103 nose bomb fuze as originally designed required 550 turns of the vane to arm the fuze for delay action and 785 turns for superquick action. Actual tests in the wind tunnel show that these figures correspond to about 1140 and 1710 ft. of air travel for the 100-lb. GP bomb and for an altitude of about 2000 ft., where the density of the air is not appreciably less than at sea level. However, this same fuze tested under the same conditions but in the 2000-lb. GP bomb, which has a blunt nose compared to the 100-lb. bomb, armed in about 2420 and 3625 ft. of air travel. The present M103 fuze, which arms in 230 and 345 turns of the vane for delay and superquick functioning, respectively, arms with about 510 and 765 ft. of air travel for the 100-lb. bomb, and 1080 and 1620 ft. of air travel for the 2000-lb. bomb.

The distance under the plane corresponding to a given air-travel arming distance can be computed from the approximate trajectory, or estimated from the speed of the plane and the air-travel arming distance. Thus, for the M103 fuze arming for delay in 510 ft. of air travel, the time in seconds required for arming at a plane (and bomb) speed of 400 ft./sec. is $510/400 = 1.3$ sec. This corresponds to a distance of free fall of $\frac{1}{2} \times 32.2 \times 1.3^2$ or 27 ft. Therefore the present M103 fuze is adapted to quite low-altitude bombing; in fact, it might be dangerous if bombs were dropped in salvo from high altitudes from a large bomb bay where turbulence would cause the bombs to bump one another.

The present M100 series of fuzes requires 175 turns to arm the fuze, and test shows this number of turns to correspond to an air-travel distance of 445 ft. for the 100-lb. bomb and 665 ft. for the 2000-lb. bomb. This fuze is armed in $445/400 = 1.1$ sec. when dropped at 400 ft./sec.; that is, it is armed $\frac{1}{2} \times 32.2 \times 1.1^2 = 19.5$ ft. below the plane.

Even so, for really low-altitude work, it is desirable to have the arming time still shorter. Arming time has been reduced with the M112 series, on which the gear reduction is omitted. The fuze arms with 18 turns of the vane, corresponding to about 60 ft. of air travel. At 400 ft./sec. this represents an elapsed time of $60/400 = 0.125$ sec. and a drop of only $\frac{1}{2} \times 32.2 \times 0.125^2 = 0.25$ ft. or 3 in. No restrictions are therefore placed on the bombardier or pilot, as they may fly in at 25-ft. altitude and the fuzes will be armed. Such bombs are almost always dropped singly.

Because of the comparatively long air-travel arming distances for fuzes with gear trains, particularly those of the older designs, partial arming of fuzes has been performed in the field by rotating the arming vane by hand so that the actual arming distance is reduced. This

practice was common when low-altitude bombing first became popular before low-altitude fuzes had been made available. It is strictly prohibited with fuzes of the present design; a delicate mechanism like a modern bomb fuze should be altered only by trained personnel. Arming time may be obtained in a wind tunnel such as is shown in Fig. 129,

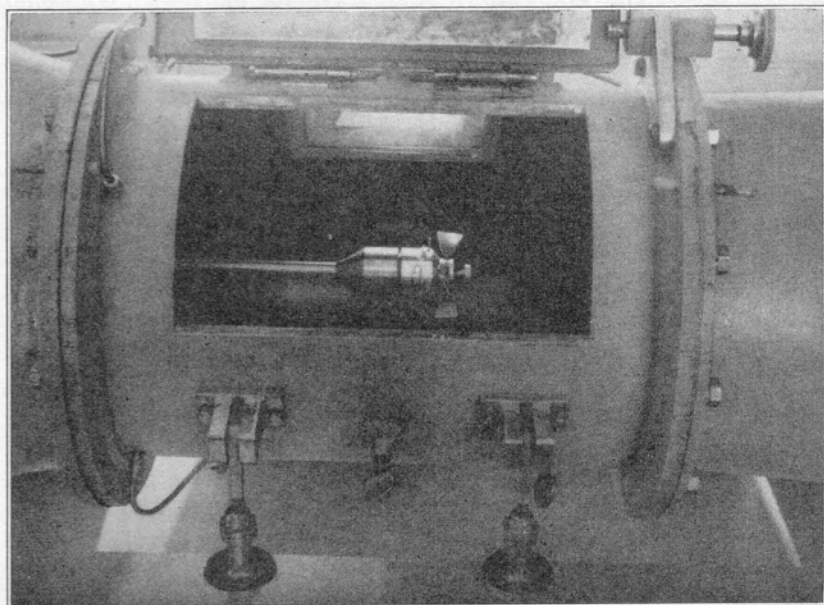

FIG. 129. Wind-tunnel test of bomb fuze.

and the general functioning of the arming-vane mechanisms at various air speeds may also be checked in the wind tunnel.

5. Classifications of Bomb Fuzes.

Bomb fuzes may be classified in a number of ways as follows:

According to Position in the Bomb.

1. **NOSE FUZES**, commonly called nose bomb fuzes, are assembled in the nose of the bomb, and correspond to point-detonating artillery fuzes.
2. **TAIL FUZES**, commonly called tail bomb fuzes, are assembled in the tail of the bomb, and correspond to base-detonating artillery fuzes.
3. **TRANSVERSE FUZES**, assembled into a cavity in the bomb body between the nose and the tail.

According to Specific Action at Functioning. (See also Art. 6, Chapter 6.)

1. **Superquick**, or instantaneous, in which a striker in the front of a nose fuze is pushed in at the target before the fuze and bomb decelerate to any degree,

thus causing the firing pin to impact the primer or detonator. The speed of action depends upon the target resistance, but this bomb action is the fastest obtainable, because the striker and firing pin hit the target first; such action is limited to nose fuzes the same as superquick artillery fuze action is limited to point fuzes.

2. Non-delay, in which an inertia element inside the fuze body must move forward on impact to function the primer or detonator. This type of action is not necessarily limited to tail fuzes, though it usually is; it is the fastest action that can be built into a tail fuze because the bomb and fuze must actually decelerate before the inertia of the plunger element causes it to move forward. This type of action is therefore inherently slower than superquick action.

3. Delay, in which a definite delay means is introduced into the fuze, such as black powder, fuze delay powder, or chemicals. Three types of delays are used in bomb fuzes, and they are of three different magnitudes for different tactical purposes and are obtained by three different actions.

(a) Short delay, of the order of 0.01 to 0.24 sec., is delay for target-penetration purposes, in order that the bomb may penetrate into a target, such as a building, soil, concrete, or armor plate, before detonating. It is usually obtained with a black-powder pellet inserted into the explosive train after the primer and ahead of a relay and detonator the same as in artillery fuzes. Either nose or tail fuzes may have such a delay incorporated in them.

(b) Medium delay, of the order of 4 to 15 sec., is delay for safety of the plane in low-altitude bombing, in order that the plane may move away from the point of impact before detonation occurs. Such a delay is a necessity of skip or low-altitude bombing, and it is usually obtained by a column of delay powder in the explosive train after the primer and ahead of the relay and detonator, for delays up to 15 sec. Such a delay is common in tail fuzes only, as it is difficult to develop a nose fuze that has enough mechanical strength and that protects the delay column and firing mechanism sufficiently when smacked into armor to completely eliminate instantaneous shots and still give reliable functioning.

(c) Long delay, of the order of magnitude of 2 min. to 5 days, is for tactical purposes, primarily to deny territory to the enemy for some period of time during which some tactical operation takes place or to allow successive waves of planes to drop their bombs before any of them detonate. Such a delay is usually obtained by chemical means, by the action of a chemical on an element so that the firing pin is released when the action has progressed to a certain point. Shorter delays within this range, say up to 10 min., may be obtained with Bickford fuse if space permits. This type of delay is usually built into tail fuzes.

4. Sensitive, a variety of superquick, in which the striker and firing pin are easily pushed in against a light spring by contact with a light target such as a wire or a twig of a tree. This type of action is usually combined with semi-always action, in which impacts from any side against the fuze striker will function the firing pin. The combination is used in the nose fuze for the parachute fragmentation bomb.

5. Time, or air burst, in which the fuze functions in air at the expiration of a definite time. The mechanical time type is generally used in which an actual clockwork mechanism is built into the fuze similar to an artillery mechanical time fuze. This type will provide delay up to 90 sec.

According to Method of Arming.

1. Arming-pin type, in which withdrawal of the arming wire allows a pin to be spring ejected. The pin passes through either the firing pin or striker, so that its ejection provides for plunger action at impact, or ejection of the pin starts a delay arming mechanism.

2. Arming-vane type, in which a vane rotates in the air stream, usually screwing or unscrewing some element that starts the arming process. We shall see exactly how this is accomplished when we study some specific fuzes. Either the arming-pin or arming-vane methods of arming may be applied to either nose or tail fuzes.

3. Hydrostatic arming, in which the water pressure must be increased up to a certain value before the fuze is armed and ready to fire.

According to Time of Arming.

1. Direct arming, in which the fuze becomes armed immediately as soon as the arming pin is ejected or as soon as the arming stem is unscrewed by direct vane action, without a gear reduction mechanism. With direct arming, the fuze is armed directly under the plane or at most several feet away.

2. Delayed arming, in which pulling out of the arming wire starts arming by pin ejection or vane rotation, but the arming is delayed by a clockwork or powder train in the pin type, and by a gear reduction device in the vane type.

NOSE BOMB FUZES

6. General.

Nose fuzes are combination firing mechanisms and explosive trains in which all elements up to and including the booster are incorporated in the complete fuze. Since they are located in the nose of the bomb, they impact the target and must stay together until the expiration of the delay, during which time the bomb penetrates the target. Nose fuzes are of heavy construction, particularly those for large bombs, and good carbon or manganese-carbon steels are required.

The M103 type is the commonest of our present nose bomb fuzes, being used on all GP bombs from 100 to 2000 lb., large fragmentation bombs of the 90- and 260-lb. sizes, certain depth bombs, and the 4000-lb. LC bomb. It is one of the heaviest of modern fuzes, weighing 3.7 lb., and is a combination superquick and delay fuze of the arming-vane type with detonator safety.

The M110 type is a superquick fuze for high-altitude fragmentation bombs of the arming-vane type without detonator safety, and the M104

and M120 are supersensitive, semi-allways, delayed arming fuzes of the arming-pin type with detonator safety.

The M108 is a very simple superquick fuze for chemical, smoke, and practice bombs where safety is not so important as where large amounts of high explosives are involved. It is an arming-pin fuze without detonator safety and is becoming obsolete.

The M111 type fuze is a time fuze giving delays up to 90 sec. but without detonator safety. It is made in a large variety of types, with different booster loadings such as high explosive, black powder, part high explosive, and with detonator only in the booster; any of these various booster loadings may be with or without a slider for detonator safety.

7. Air Burst of Bombs.

During recent years an effort had been made to obtain air burst bombs, particularly when fragmentation effect is desired. Air burst means that fragments are propelled downward over a large area from the point of burst, whereas, if the burst is on the surface just below, the cone of fragments will be expanding upwards. This is why if men are dug in foxholes and trenches it takes almost a direct bomb hit to kill them. The effect of air burst is shown in Fig. 130.

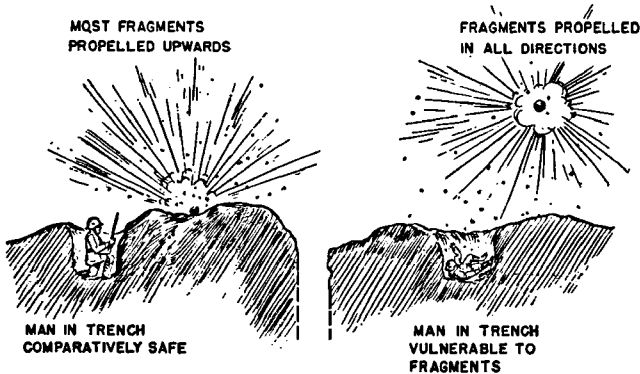

FIG. 130. Advantage of air burst over ground burst of bombs and shell.

The first effort to obtain air burst was by means of fuze extensions which place the fuze from 6 to 36 in. from the bomb. The M1 extension consists of a cardboard tube of tetryl inside a steel tube about 2.375 in. in diameter connecting the M103 type fuze at one end with the bomb adapter booster at the other. It provides air burst, but the type of target is still a factor, as the extension tube being long and thin penetrates normal soil even more readily than the bomb itself.

Another effort to obtain air burst is by the air-pressure type of nose fuze, in which a cupped metal disc of the Belleville spring type is placed in the nose of the fuze in place of the usual striker. When bombs fuzed with air-pressure fuzes are dropped in salvo, the first bomb will detonate on impact and other bombs are expected to burst in the air, several feet from the ground, because the blast from the first bomb functions the fuzes of other bombs before the impact. The M149 fuze is such a fuze, and is a substitute for the M103 type.

Since the barometric pressure varies with altitude, fuzes have been designed based on the principle that functioning will occur when the pressure of the atmosphere increases to a preset value as the bomb drops. Some success has been obtained with these fuzes, but functioning is affected by local atmospheric conditions and terrain.

Still another way to obtain air burst is by means of a time fuze set to burst in the air at the expiration of a given time. The M111A2 fuze with a tetryl- instead of a black-powder-loaded booster, known as the M127, is used for GP bombs for this purpose. The M117 adapter booster adapts the $1\frac{1}{2}$ -in. fuze threads to the 2-in. fuze well threads.

All these attempts to obtain air burst have certain disadvantages. The fuze extension has the disadvantage that the target resistance affects the time of detonation, so that, for example, on sandy soil the extension and bomb may move several feet into the target before detonation. Also, the fuze extension can hardly be long enough to obtain burst in the neighborhood of 40 ft. off the ground, as is desired. The air-pressure fuze depends on the blast of a bomb just ahead of it, and the distance above the ground at which it functions will vary considerably. A single bomb cannot be reliably functioned by the air-pressure method. The mechanical time fuze has the disadvantage that it does not function at a given distance from the ground but at the expiration of a set time, so that, if the bomb falls into a valley, it will burst far above the ground, whereas if the bomb falls over a hill it may impact before the expiration of the set time. The barometric fuze is subject to local atmospheric conditions and functions on barometric pressure, not on distance from the ground.

The ideal nose fuze for air burst is therefore seen to be one which automatically integrates the factors involved, including the most important one of distance from the ground. The fuze itself should know when it is approaching the ground and detonate itself at just the right time.

8. Nose Fuzes for GP Bombs.

The AN-M103A1 Fuze. This fuze, shown unarmed, armed for delay action, and armed for superquick action in Figs. 131, 132, and 133, re-

spectively, is a combination superquick and short-delay (0.10 sec.) impact fuze of the delayed-arming vane type with detonator safety; it weighs 3.7 lb., is 7.1 in. long and 2.48 in. in diameter, and is used in all GP and HC bombs, as well as in some fragmentation and depth

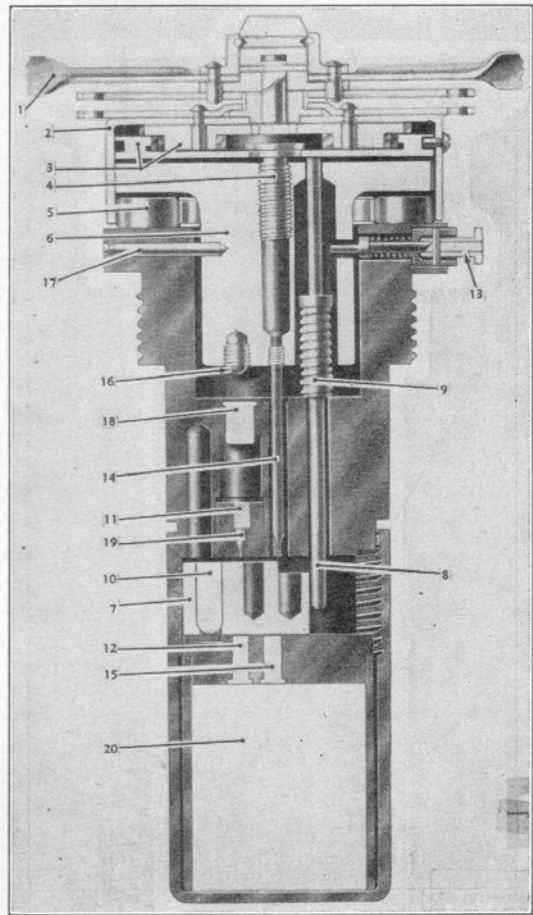

FIG. 131. M103A1 nose bomb fuze, unarmed.

bombs. The fuze may be set from the outside by a setting pin (13) just above the 2-in. threads where the fuze screws into the bomb. Because of a set of reduction gears (3) and (4) it requires about 230 turns of the vane (1) for delay action and 345 turns for superquick action, corresponding to about 500 ft. of air travel, so that the fuze is suitable in medium-altitude but not extremely low-altitude bombing.

The fuze is cylindrical and has a two-bladed arming vane prevented

from rotating by the arming wire passing through the vane and a bracket on the vane cup (2). Below the arming mechanism and slider (7) is the large heavy booster cup containing 825 grains of tetryl (20). Under the vane cup is a heavy striker (6) which is pushed in at impact to

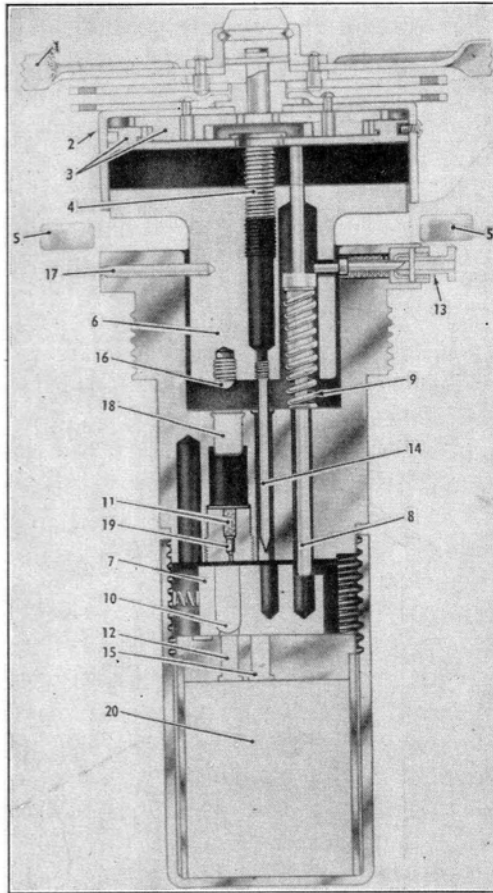

FIG. 132. M103A1 nose bomb fuze, armed delay.

overcome the resistance of the shear pin (17). The essential parts of the fuze are shown in Fig. 131.

As the vane cup is unscrewed by rotation of the vane it moves away from the striker and exposes the safety blocks (5), which are spring ejected. After the vane cup falls off, the striker is exposed and is prevented from moving down against the primer (18) by a shear wire and by the inner end of the setting pin. The arming stem (8) also moves up as the vane cup unscrews, owing to spring action (9); the extent to which it moves

up determines how far over the slider will move, and whether the action will be superquick or delay. If it moves up only to the point where its collar hits the inner end of the setting screw, the slider moves only part way over by spring action and the detonator (10) is lined up with

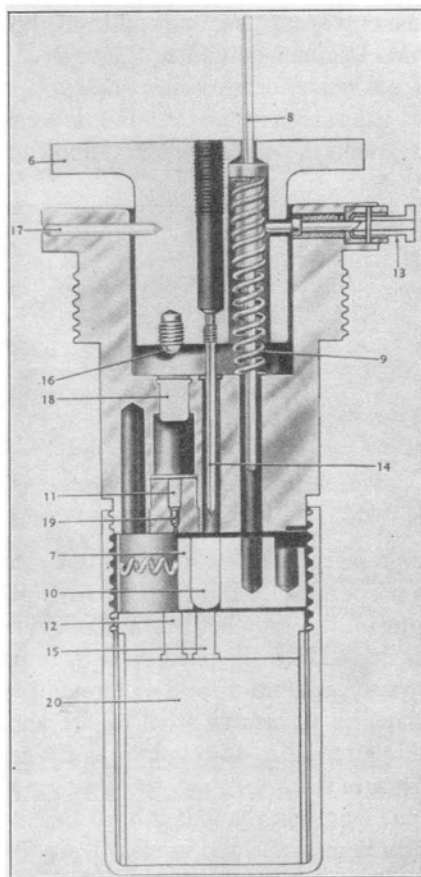

FIG. 133. M103A1 nose bomb fuze, armed superquick.

the delay explosive train (11) and (19), functioned by the plunger firing pin (16) hitting the primer at impact. If the arming stem moves up past the setting screw, the detonator moves all the way over, and the detonator is in line with the central firing pin (14) which hits it directly on impact. The slider is locked in the arming position in either event, and there are two booster leads (12) and (15), one for each position. The vane cup may not fall off if the air speed is too great.

The complete-round table at the end of this chapter shows with what bombs this fuze is used and the characteristics of the fuze itself.

The M139 and M140 Fuzes. This fuze is identical to the M103 except that it is a combination superquick and 0.01-sec. delay instead of superquick and 0.10-sec. delay. The fuze is identified by a black segment, Fig. 134, on the vane cup occupying one-eighth of the surface, the same as on the 0.01-sec. M14 primer detonator. It is used when the tactical situation requires a nose fuze for very short delay.

The M140 fuze is the same except that the delay is 0.025 sec. and a one-quarter black segment is painted on the vane cup.

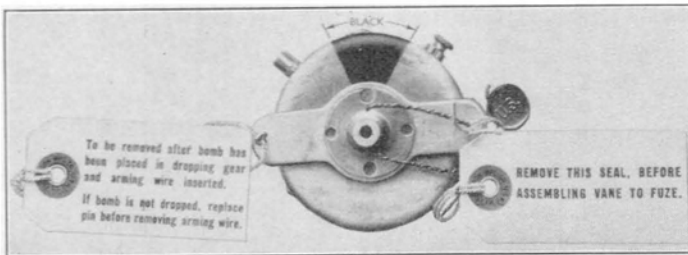

FIG. 134. M139 nose bomb fuze.

Air-Burst Fuzes.

1. The M149 air-pressure fuze has somewhat the same appearance as the M103 fuze, but it operates by the air pressure pushing in a thin convex brass diaphragm of the "cricket" or a Belleville washer type, so that the firing pin is driven into the primer. It is armed by a six-bladed vane unscrewing a vane cup, and after 8 or 9 revolutions an arming pin is spring-ejected, allowing an arming stem to rise and the detonator to move into alignment; after 12 to 14 revolutions the vane cup itself falls off, exposing the pressure disc.

This fuze is 7.5 in. long and extends 2.5 in. beyond the bomb nose. It should be used with bombs released in close train (0.05-sec. intervals), and it causes bombs fitted with it to operate by blast effect about 25 ft. off the ground.

2. The M127 time fuze is exactly like the M111 type fuze except that the black-powder booster of the M111 is replaced by a high-explosive booster. The M127 fuze, Fig. 144, can then be used to obtain air burst of high-explosive GP bombs fitted with the M117 adapter booster. It still does not provide detonator safety, a highly desirable feature when large quantities of explosives are involved, but by merely changing the type of booster a time fuze for GP bombs was made available immediately, pending development of a detonator safe fuze, discussed below.

3. Detonator-safe time fuzes. The M111 type mechanical time fuze, originally developed for the aircraft bombardment flare, was later applied to the large photoflash bomb. Such applications require a fuze with a black-powder booster, not necessarily with detonator safety. With the demand for air burst of GP bombs, it became necessary to provide a detonator safety feature to the M111 fuze. The M128 fuze, shown in Fig. 144, is the M127 fuze with a longer body to provide space for a slider with out-of-line detonator; it is suitable for GP bombs, chemical bombs, and aimable clusters of bombs, but when used in GP bombs the M117 nose adapter booster is necessary.

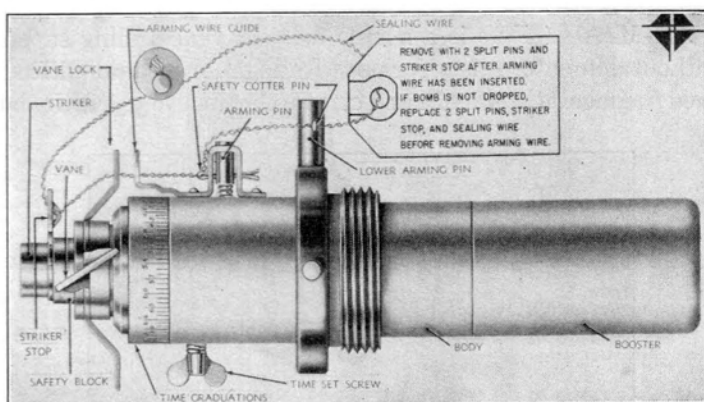

Fig. 135. M135 nose bomb fuze.

However, in order to provide a nose time fuze for GP bombs with detonator safety that would fit the cavity for the M103 fuze, a new time fuze of different contour was developed, as shown in Fig. 135, for GP bombs and large fragmentation and chemical bombs usually taking the M103 fuze. This fuze, with the usual 5- to 92-sec. time, and requiring 260 turns of the vane to arm it, is known as the M135. The same fuze modified for a total time of 30.6 sec. in order to obtain more accurate calibration over the time range is called the M136 fuze.

Nose Fuzes for Low-Altitude Bombing. The requirements for a nose fuze for low-altitude bombing are extremely severe. A delay of at least 4 sec. must be incorporated into the fuze body in order that the low-flying plane may have a chance to get away from the point of impact. As a comparatively delicate mechanical time mechanism will not stand up under the severe impact conditions, a powder delay column is needed, and it must be protected against failure by breaking up and interrupting the delay. Instantaneous shots are strictly prohibited, or the plane dropping the bomb may be blown up. Furthermore, even though skip

bombing may not be intended against heavy armor plate, nose fuzes must be designed to function even when they impact the heavy side armor of ships head on at 600 ft./sec., and it is highly desirable, if the target is a floating or a submerged water target, and it is missed, that the fuze be sensitive enough to detonate on water impact—a difficult requirement of a nose fuze, when considered with the other requirements. Nose fuzes for this purpose have been developed but are not yet considered really satisfactory; tail fuzes, such as the M112 and M115 series, much more nearly meet the demands.

9. Nose Fuzes for Fragmentation Bombs.

The AN-M110A1 Fuze is a simple delayed vane-arming superquick fuze without detonator safety for use with high- or medium-altitude fin-stabilized fragmentation bombs and certain chemical and practice bombs.

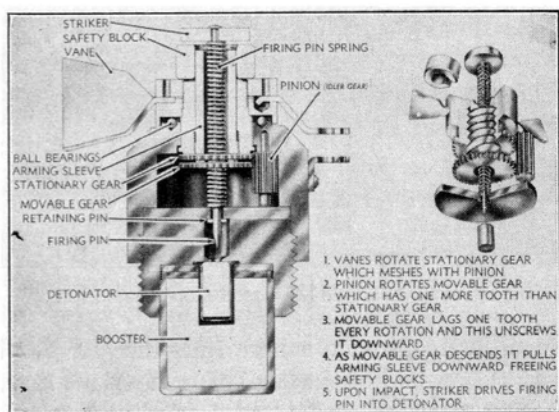

FIG. 136. M110A1 nose bomb fuze.

It is shown in Fig. 136. It weighs 1.04 lb. and is 3.7 in. long; its cylindrical body is 1.75 in. in diameter. A C-shaped safety block is placed between the striker at the top and the fuze body. The fuze arms with about 325 revolutions of the vane because of the 34 to 1 gear ratio, and the vane hub assembly consists of an arming sleeve, hub sleeve, upper ball race, vane, and vane nut. A vane bracket or strap forms the vane stop by being held from rotation by the arming wire.

As the vane rotates the arming assembly rotates, the rotation causing the sleeve to be withdrawn from the safety block until it falls away by centrifugal force. The firing pin is then held away from the detonator only by a spring, and upon impact the striker is pushed down against the force of this spring.

The AN-M104 Fuze. Figure 137 shows the M104 fuze, which is of the sensitive, semi-allways delayed arming-pin type with detonator safety for low-altitude parachute fragmentation bombs. It is 4.4 in. long and 2.25 in. in diameter and weighs 1.15 lb. The delay element is a

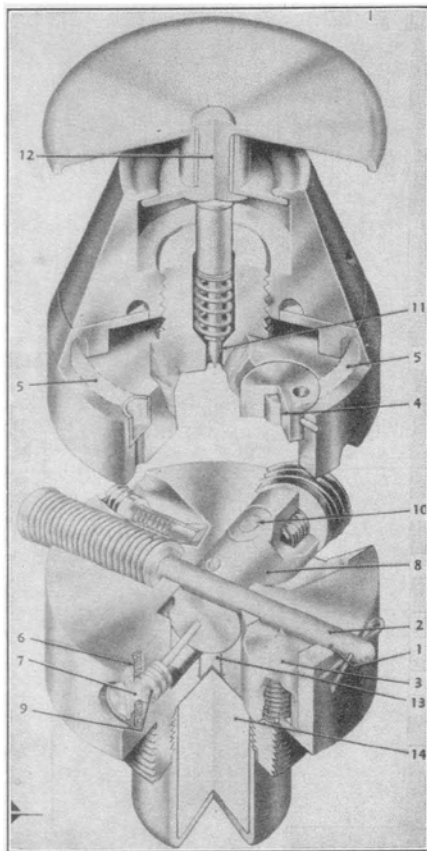

FIG. 137. M104 nose bomb fuze.

powder train ring (5) giving 2.5-sec. delay after the arming pin (2) is ejected before the slider (8) moves over to the armed position. This fuze has 1.5-in. threads where it screws into the bomb, and it is used on the 23-lb. M40 type of parachute bomb. The delay would give the plane a chance to get away if the parachute were to fail, as, even if impact occurred before the expiration of the delay, the detonator would not be in line.

The fuze has a wide flat striker (12), against which the firing pin (11)

is held by a weak spring, which also serves to keep the firing pin away from the detonator (10) until impact. Upon withdrawal of the arming wire from a hole (1) in the arming pin, the arming pin, which holds both

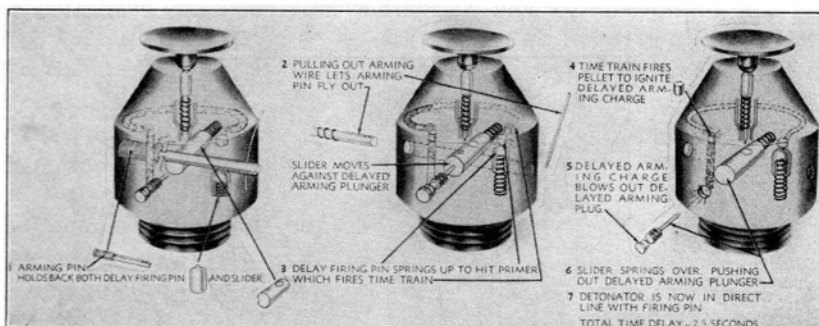

FIG. 138. M104 nose-bomb-fuze arming.

the slider and the delay firing pin (3) in the unarmed position is, withdrawn, allowing the spring-actuated delay firing pin to hit the primer (4), which starts the delay column burning. The slider may still not

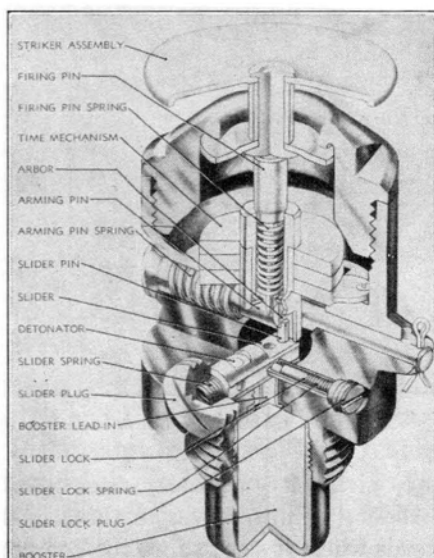

FIG. 139. M120 nose bomb fuze.

move to the armed position because the delay arming plug (7) and (9) holds it in, but when the delay column has burned around to this plug it is ejected by a powder charge (6), and the slider moves to the armed

position by spring action. Then, upon impact with even a light target against the striker from any angle, the striker pushes the firing pin into the detonator, causing the booster lead (13) and booster (14) to detonate.

Figure 138 illustrates these events in sequence.

The AN-M120 and AN-M120A1 Fuzes. The M120 fuze is similar to the AN-M104 except that the 2.5-sec. delay is accomplished by mechanical time rather than powder train delay, and the M120A1 is the same except that it has 1.9-sec. delay arming. Both these fuzes allow the slider to move to the armed position by the clockwork mechanism

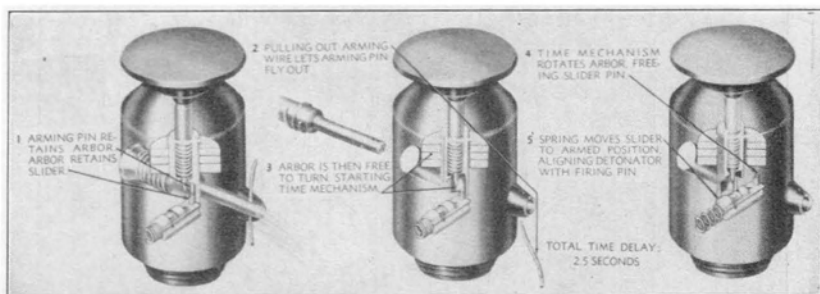

FIG. 140. M120 nose-bomb-fuze arming.

rotating an arm out of engagement with an arbor on the slider, which then moves by spring action. The AN-M120A1 has been replaced by the M104 and M120 types for parachute fragmentation bombs.

Figure 139 shows the parts of the M120 fuze, and Fig. 140 the arming sequence.

The M129 Series. This is not a series of fuzes similar to a tail bomb series of three fuzes of the same construction except for stem length, but it consists of three different interchangeable fuzes for the 4-lb. butterfly bomb. The M129 is a combination air burst and impact fuze having a cocked firing pin which releases in the air, if so set, after $2\frac{1}{2}$ to 3 sec., or on impact provided that $2\frac{1}{2}$ to 3 sec. have elapsed in flight. The M130 is a time fuze designed for either 10-, 20-, or 30-min. delay, after which it functions. The M131 is an antidisturbance fuze containing a $2\frac{1}{2}$ -sec. delayed arming feature, and after impact a slight disturbance releases a cocked firing pin.

These fuzes have more or less the same general appearance, Fig. 141, are $1\frac{3}{4}$ in. in diameter, and are armed by rotation of the "butterfly wings" which unscrews a stem from the fuze, thus initiating arming. They are all mechanical time fuzes, either in arming time, delay time, or both. They allow a large quantity of small fragmentation bombs

to be scattered over an area with four types of fuze action mixed up as desired: air burst, impact, long delay, and antidisturbance.

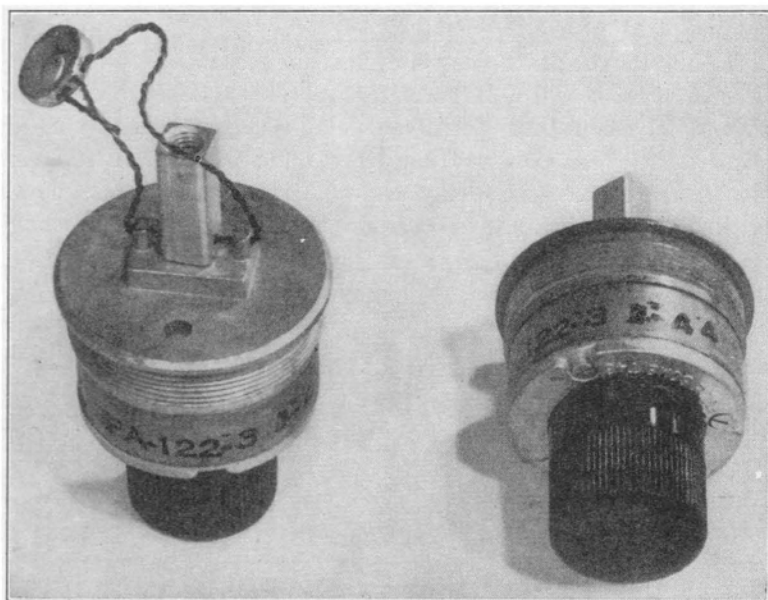

FIG. 141. M129 bomb fuze.

10. Nose Fuzes for Chemical, Smoke, and Practice Bombs, and Bomb Clusters.

The M108 Fuze is perhaps the simplest nose bomb fuze. It is an arming-pin type without delayed arming or detonator safety and without booster cup. It is shown in Fig. 142. It is 2.66 in. long and weighs 0.54 lb. It consists of a small cylindrical body 1 in. in diameter with a striker at the top under the head of which is a safety block held in place by a safety plate. The arming wire holds this safety plate in place, and when it is withdrawn the safety plate falls away, and the safety block and arming pin are spring-ejected. Then nothing restrains the striker and arming-pin assembly except a thin shear wire, which is sheared at impact, the firing pin hitting the detonator. The fuze has no booster and is held in the fuze seat by two balls behind which are springs, causing the balls to snap into sockets in the fuze seat.

This fuze is suitable for bombs not requiring boosters such as the chemical, practice, and smoke bombs having bursters which can be initiated by the fuze detonator.

The AN-M126A1 Fuze is exactly like the M110A1 except that the latter's high-explosive booster has been replaced by a detonator only

in the booster, for use on chemical, smoke, and incendiary bombs having a high-explosive burster or for clusters requiring initiation of primacord.

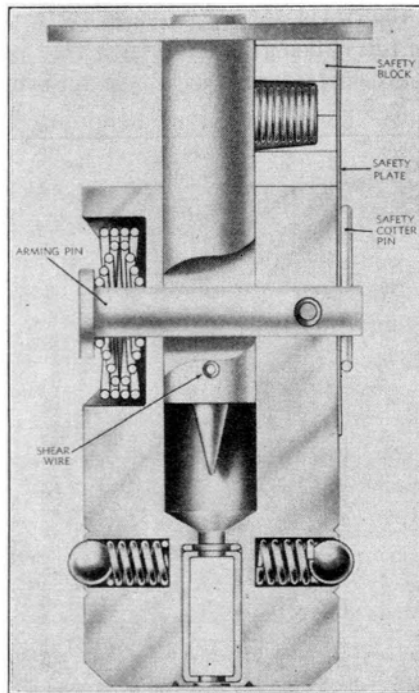

FIG. 142. M108 nose bomb fuze.

Time Fuzes.

1. The M111A2 fuze was developed as a mechanical time, combination vane and arming-pin delay arming, bombardment flare fuze to give air burst after the expiration of 5 to 92 sec. or to function on impact after completion of arming, even though the time for which it was set had not expired. The fuze is 4.5 in. long and 1.75 in. in diameter, weighs 1.4 lb., has $1\frac{1}{2}$ -in. threads, and is shown in Fig. 143. The C-shaped safety block is similar to that in the M110A1 fuze, and the arming sleeve is withdrawn in the same way so that the block falls out after about 260 revolutions. If impact occurs the fuze will fire. Withdrawal of the arming wire allows ejection of the arming pin, which starts the mechanical time delay mechanism, the spring-actuated firing pin is released, which fires the primer and the black-powder booster.

This fuze is used on the M26 aircraft parachute flare and the M46 photoflash bomb. If the booster cup loading is changed from black

powder to high explosive, the fuze is adapted to obtain air burst of GP bomb (M127 fuze).

2. The M138 fuze is exactly like the M111 except that the black-powder booster of the M111 fuze is replaced by a part high-explosive booster, half of the tetryl being replaced by a clay pellet. This fuze is used in aimable bomb clusters wherein the cluster is opened by means of

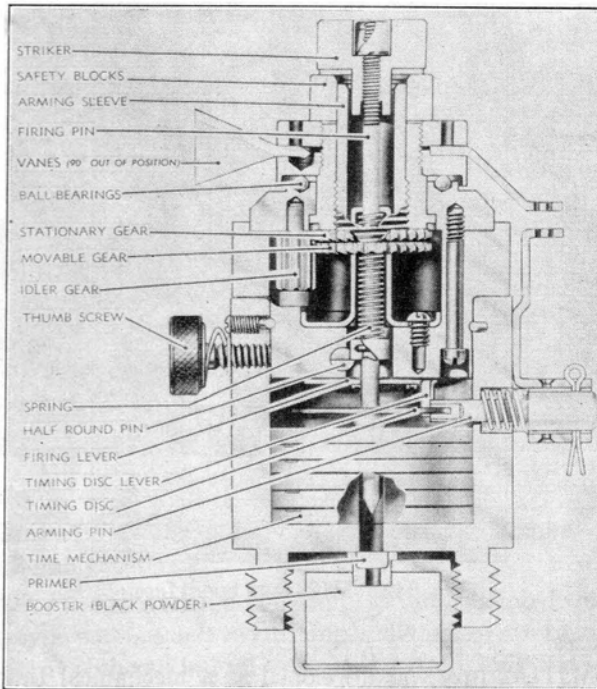

FIG. 143. M111A2 nose bomb fuze.

primacord initiated by this part high-explosive booster. The M127 and M138 fuzes may be used in aimable clusters requiring a high-explosive booster.

3. Other time fuzes. Certain aimable clusters require a fuze like the M138, except that detonator safety is desirable. The fuze having the longer body to accommodate a slider, but having the usual 5- to 92-sec. delay and the combination tetryl-clay booster, is called the M145, Fig. 144. This same fuze with a black-powder booster, called the M146, is used to open the clusters of 4-lb. butterfly bombs, M28 and M29, and in the M26 flare and M46 Photoflash bomb, the advantage over the M111A2 being detonator safety.

The M111A2 fuze, modified to arm in 6-9 turns of the vane instead of 260, is used in fragmentation bomb clusters and is called the M155.

Two other nose time fuzes are available for the target identification bomb, the M144, a direct-arming (6-9 turn) detonator-safe, black-powder booster fuze, calibrated between 1.6 and 30.6 sec.; and the M147, Fig. 144, a delayed-arming (260 turns), detonator-safe fuze having a detonator only in the booster and having the usual 5- to 92-sec. delay time.

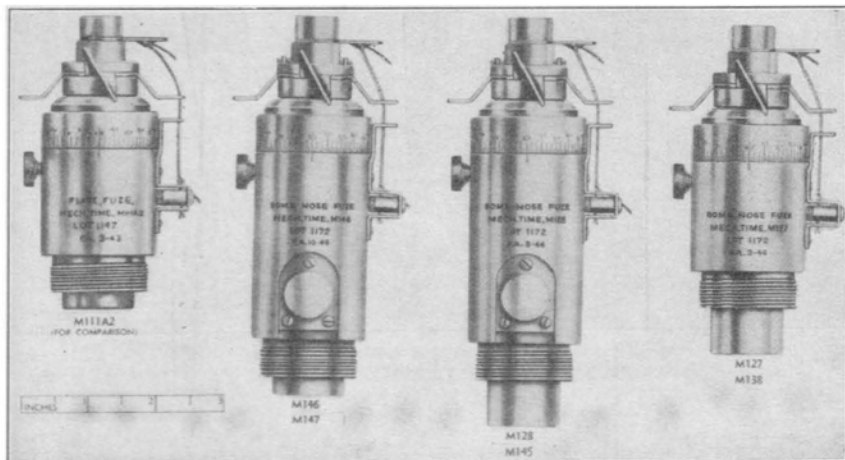

Fig. 144. Mechanical time nose bomb fuzes.

11. Nose Fuzes for Depth Bombs.

The AN-Mk 219 Fuze is a nose fuze of Navy design for all sizes of depth bombs; it is of the superquick delayed arming-vane type with detonator safety, requiring 175 revolutions for arming. It is used in depth bombs for surface demolition effect. It is 5.5 in. long and 2.3 in. in diameter, and it weighs 4 lb. Rotation of the vane drives a 23 to 1 gear reduction mechanism which brings the firing-pin extension, firing pin, detonator, auxiliary booster lead, booster lead, and booster into line. The rotor is locked in position by a detent. Upon impact the head assembly, including the striker, shears the shear pin and causes the firing pin to shear its pin and impact the detonator.

In addition to depth bombs, this fuze may be used on Navy fragmentation, chemical, and demolition bombs. It is shown in Fig. 145, and the arming sequence is shown in Fig. 146.

The M103 fuze with a special vane to give proper arming may be used with a flat-nose depth bomb, the special vane being required because of the air-stream conditions at the nose.

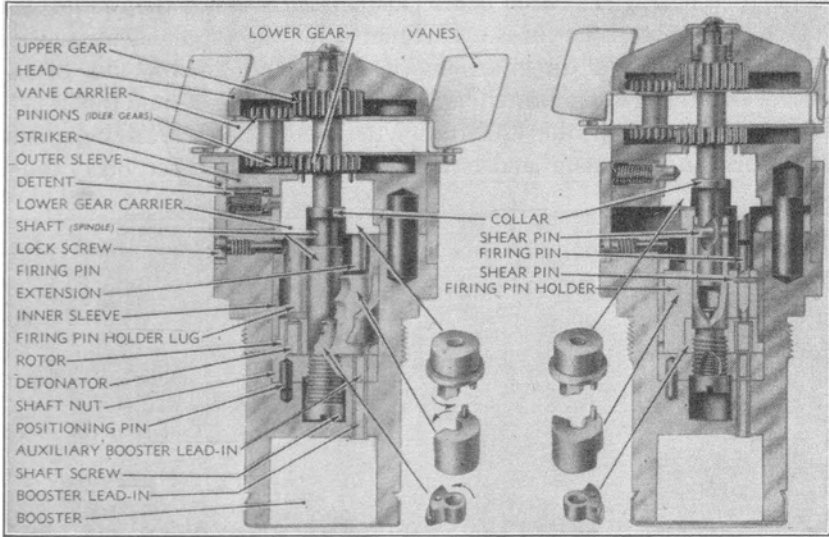

FIG. 145. Mk 219 nose bomb fuze.

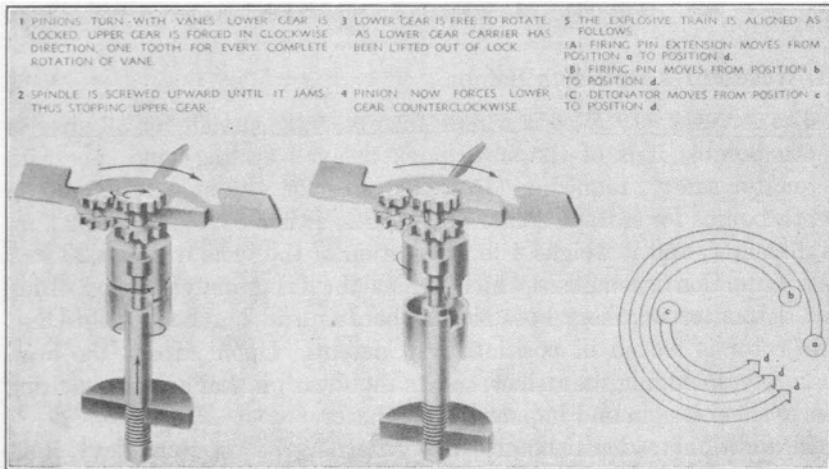

FIG. 146. Mk 219 nose-bomb-fuze arming.

TAIL BOMB FUZES

12. General.

Tail bomb fuzes are screwed into an adapter booster which screws into the base plug which closes the tail end of the bomb by joining with the tail cone. Tail fuzes are primarily firing mechanisms, plus a detonator, the booster being part of the adapter. Arming-vane tail fuzes are longer than nose fuzes in order to place the arming away from the bomb base so that the air stream will definitely rotate the vanes. Because the distance from the adapter booster to the end of the fin assembly varies

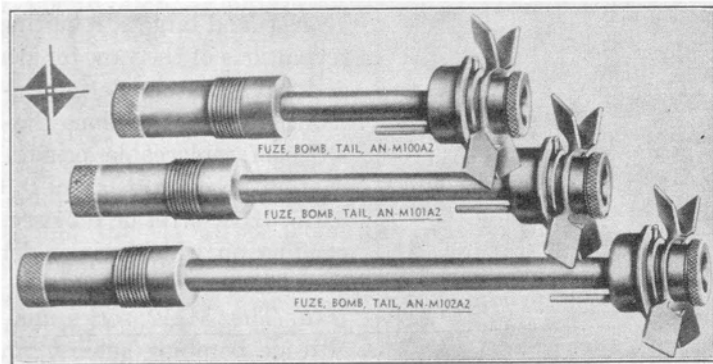

FIG. 147. Three stem lengths for M100 series tail bomb fuzes.

greatly with bomb size, as larger bombs require more fin area and length for stabilization, the tail fuzes cannot all be the same length. Three lengths have been found to fill the requirements: the shortest fuze stem length with an overall length of fuze of 9 in. is suited to the 100- and 250-lb. bombs; the medium length with a fuze length of 12 in. to the 500-lb. bomb; and the longest with a fuze length of 16 in. to 1000-lb. bombs and larger. The three lengths of fuzes of a given type are assigned consecutive M numbers. The M100 fuze is a short fuze of a given type, and the M101 and M102 are progressively longer, as shown in Fig. 147.

Tail fuzes are usually not detonator safe because the space limitations prohibit it and the absence of the external striker used in nose fuzes greatly decreases the hazard due to accidental hitting or dropping of the fuze. Tail fuzes could be designed for the larger diameter of the M115 adapter booster instead of the smaller M102 adapter booster with sliders to provide the out-of-line feature. In this respect, the requirement that a tail fuze have a diameter of 1.3 in. and a body length of only about 4 in. in order to fit the M102 adapter booster and not pro-

trude very far beyond it, does impose definite restrictions on the designer. Perhaps a relaxation of this requirement would result in better tail bomb fuzes having many identical parts, say something similar to our

standard point fuze system for artillery fuzes.

At the present time there are five principal series of tail fuzes for GP bombs, four of which are shown in Fig. 148.

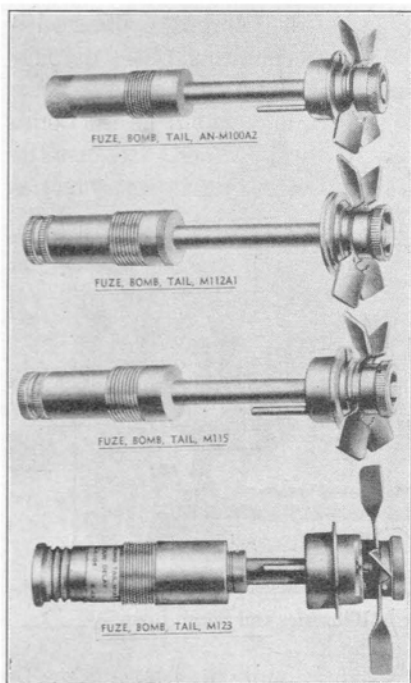

FIG. 148. Various tail bomb fuzes.

(a) The M100 series for medium- to high-level bombing against land targets, requiring 175 revolutions of the vane for arming, and having a simple inertia-type plunger which functions the M14 series of replaceable primer detonators, giving a delay of 0, 0.01, 0.025, 0.05, 0.10, or 0.24 sec., depending on which primer detonator is used.

(b) The M112 series for low-altitude bombing against land or water targets, requiring only 18 revolutions of the vane for arming, and having a cocked-firing-pin type of plunger which functions the M16A1 primer detonator with

either 4- to 5- or 8- to 15-sec. delay, so that the plane will not be in danger when the bomb detonates.

(c) The M115 series for medium- to low-altitude bombing against land and water targets, requiring 150 revolutions of the vane for arming, and having the cocked-firing-pin type of plunger for use with the M16A1 primer detonator. It combines the cocked-firing-pin features of the M112 series with the longer arming of the M100 series, resulting in a fuze safer than the M112 and more sensitive than the M100, but not suitable for such low-altitude work as the M112 because the fuze would not be armed if dropped from too low an altitude. The M115 type is preferred by the Navy to the M112 type, whereas for skip bombing the Army prefers the M112 type.

(d) The M123 series for bombing at any altitude against all targets but primarily against the usual land targets not including armor plate or concrete, requiring only a few revolutions of the arming vane to

initiate arming but several more to complete arming and seal the fuze, and having a cocked firing pin released after a delay of 1 to 144 hr. by the action of a chemical on a plastic collar. The delay for each fuze is established by the relationship between the chemical and control of the dimensions and shape of the plastic elements. This series of fuzes is intended primarily to deny territory to the enemy, and, by mixing up the delays, bombs may detonate over an enemy airport all the time from a few minutes up to 5 days or longer, depending upon temperature and other factors. An antiwithdrawal device discourages bomb disposal work.

(e) The M132 series for low-altitude bombing, requiring only several turns of the vane to initiate arming, and having a cocked firing pin which is released after about 10 min. delay by the action of a chemical on a plastic element. This fuze also has an antiwithdrawal device and is adapted to tactical bombing wherein an entire formation of planes can drop their bombs on a target before any of them start to detonate.

In addition to these five series of tail fuzes, four of which are shown in Fig. 148, the M106 type of tail fuze was used to give about 45 sec. delay by means of Bickford fuse; it is of the arming-pin type, made in one length for all GP bombs. The Mk 228 is a detonator-safe delayed arming-vane fuze having a fixed delay of 0.08 sec., for use with the Mk series of AP bombs and with 2-in. threads for use in the M115 adapter booster. The Mk 229 and Mk 230 hydrostatic tail fuzes will be discussed in Art. 25.

13. Primer Detonators.

Tail fuzes for GP bombs are usually constructed so as to permit of replaceable primer detonators, in order to obtain different types of action at the target and to provide an easy method of changing the delay of a tail fuze just before takeoff to allow for the tactical situations expected.

The first requirement is for a series of primer detonators for standard tail fuzes for GP bombs, for which different delays are required for target-penetration purposes. To satisfy this requirement, the M14 series, Fig. 149, was developed for use in the M100 series of tail fuzes. It consists of six primer detonators having delays of 0, 0.01, 0.025, 0.05, 0.10 and 0.24 sec., the delay being obtained by means of black powder. The face of the large diameter, which can be seen after the primer detonator is screwed into the fuze, is left unpainted for non-delay, and painted black for the 0.10-sec. delay. The 0.01-, 0.025-, and 0.05- sec. delays have black one-eighth, one-fourth, and one-half segments, respectively. The 0.24-sec. delay has green lacquer on its face. All have the delay stamped on the face of the large diameter.

The explosive train consists of a New No. 4 primer, the black-powder delay, a relay, and a detonator. Igniting powder may be put in the space between the primer and delay charge. The M14 primer detonator is shown in Figs. 149 and 150; it is easily identified by the knurling over

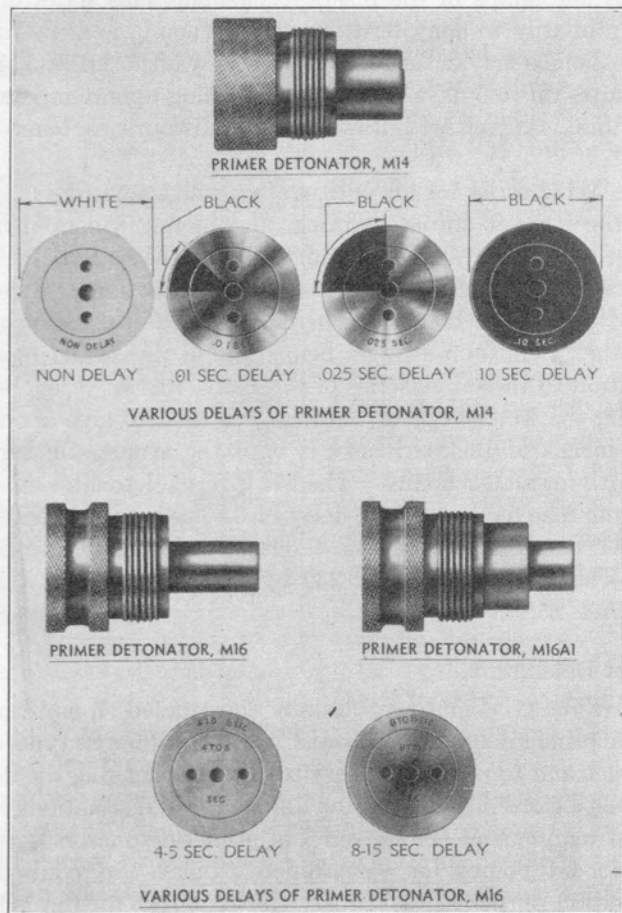

FIG. 149. Primer detonators.

the body portion having the large diameter. Fuzes are usually furnished with the 0.025-sec. delay as standard.

A second requirement for primer detonators is for use with tail fuzes for low-altitude bombing; a minimum of 4-sec. delay is required to allow for safety of the plane rather than for target penetration. For this purpose the M16A1 series of primer detonators, Figs. 149 and 150, was developed for the M112 and M115 series of tail fuzes for GP bombs.

Two delays are available, one of 4-5 sec. primarily for water targets, and one of 8-15 sec. primarily for land targets.

The explosive train for the 4- to 5-sec. delay primer detonator consists of a New No. 4 primer, a small charge of igniter composition of red lead-silicon powder, a small charge of intermediate composition of half and half igniter composition and delay composition, and the actual delay charge of about 14 grains of lead chromate-silicon powder pressed at about 40,000 lb./sq. in. This charge is followed by a relay and detonator.

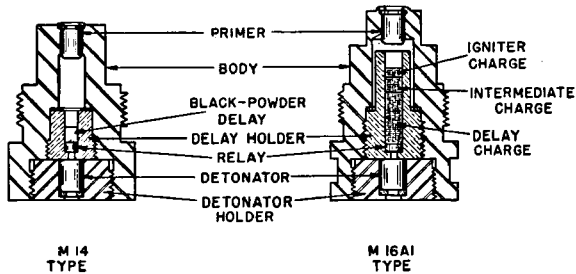

FIG. 150. Details of primer detonators.

The 8- to 15-sec. delay explosive train is similar except that the delay composition is 21 grains of a barium chromate-manganese powder pressed at 40,000 lb./sq. in. The igniter composition is the same, and the intermediate composition half and half of igniter and delay composition. Both types of delay powder are self-supporting and essentially gasless in their burning. Other delay compositions of the gasless fuze powder type, such as zirconium-nickel-barium chromate, have been tried successfully.

The M16A1 series of primer detonators is identified by the two knurled portions on the body, both of the maximum diameter. The general construction of these primer detonators is the same, in that the delay charge holder, containing the delay charge and the relay, is a separate assembly in a brass body, the primer detonator body is of steel containing the primer, and the detonator holder or closing plug is of steel containing the detonator.

14. The AN-M100A2 Series.

This series, used by both services, consists of the M100A2, M101A2, and M102A2 fuzes, all 1.5 in. in diameter, weighing 2.7, 2.9, and 3.2 lb., and having lengths of 9.2, 12.2, and 16.2 in., respectively. They are alike except for the length of the arming-stem tubes and arming stems. Because of the 30 to 1 reduction gear train, it requires 175 revolu-

tions of the vane to unscrew the arming stem from the inertia plunger, and these fuzes are therefore not suited to low-altitude bombing.

The M100A2 fuze is shown in Fig. 151, the principal parts being the arming head assembly with vane and reduction gears, the arming stem and tube, the body enclosing the inertia plunger, safety pin, creep spring, and the primer detonator assembly. As the vane rotates, the arming

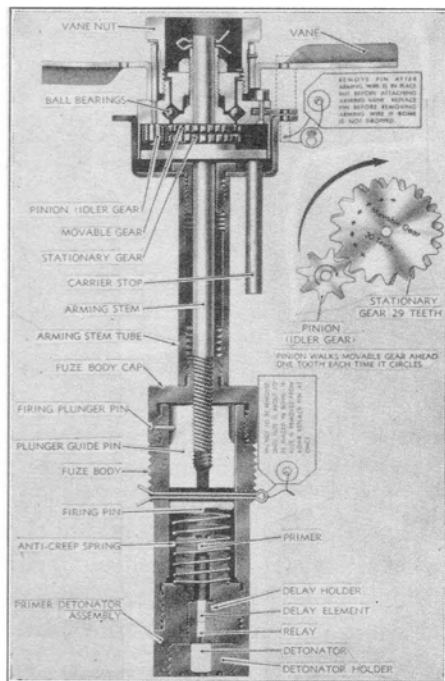

FIG. 151. M100A2 tail bomb fuze.

stem is unscrewed from the firing mechanism until the firing plunger is free, being restrained only by the creep spring. As this takes place, the amount that the stop rod which passes through the cup, extending towards the body parallel to the stem, projects below the cup is decreased by about 0.6 in. as the head rises. Even though the fuze is armed at this point, further rotation of the vane, up to 375 total revolutions, allows the arming head and stem assembly to be carried clear of the fuze in the air stream. Then on impact the inertia of the plunger carries it forward to impact the primer.

The A1 series had a different gear ratio so that 675 revolutions were required for arming.

This series of tail fuzes is used on all GP and LC bombs, the 260-lb.

fragmentation bomb, 500-lb. incendiary bomb, and on 500- and 1000-lb. SAP bombs, making it the most widely used series of tail fuzes. The 0.025-sec. M14 primer detonator is shipped with these fuzes and may be replaced by primer detonators of other delays in the field.

15. The M112A1 Series.

This series of fuzes was developed primarily for skip bombing by the Army, and the requirements were no instantaneous shots, proper delay

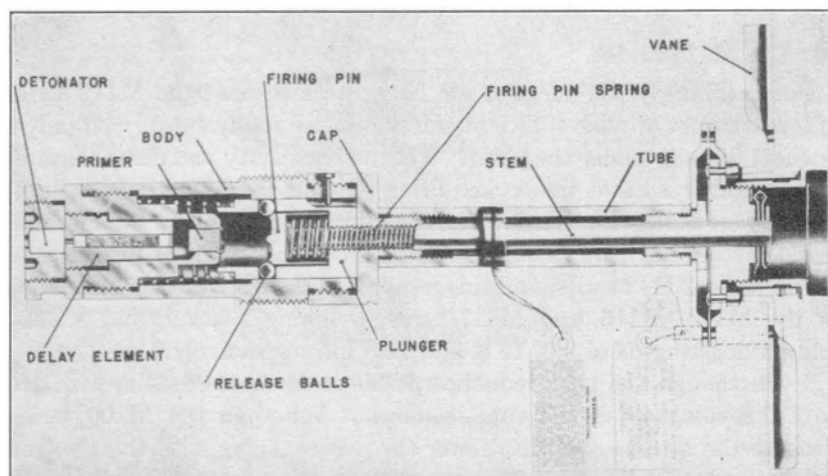

Fig. 152. M112A1 tail bomb fuze.

after impact for safety of the plane, quick arming for low-altitude work, extreme sensitivity to guarantee functioning on water, and safety. To meet these requirements, the M112A1, M113A1, and M114A1 fuzes were developed, weighing 2.3, 2.5, and 2.8 lb., and having lengths of 9.6, 12.6, and 16.6 in., respectively. Of course, the fuze diameter is 1.5 in., the same as all standard tail fuzes which screw into the M102 adapter booster. The M112A1 fuze is shown in Fig. 152.

The vanes are connected directly to the arming stem without any reduction gears, and it requires only about 20 revolutions to unscrew the stem from both the plunger and the body cap, into which it is screwed in assembly. After the arming stem is unscrewed, only the creep spring restrains the plunger. About 18 additional turns cause the arming vane and stem assembly to be carried free of the fuze by the air stream. The firing mechanism is of the cocked-firing-pin type, and upon impact the plunger moves forward to allow the locking balls to fall into a recess, so that the comparatively strong firing-pin spring can force the firing

pin into the primer with a force much greater than would be obtained by the inertia forces of skipping on water. It is this cocked-firing-pin arrangement that gives the fuze its sensitivity, the pin being released by dropping the fuze only 1 in. on wood, so that it is sensitive to graze impact as well as direct impact. Quick arming is obtained in less than 100 ft. of air travel by omitting the gear train, and delay of 4-5 or 8-15 sec. is obtained by means of the M16A1 primer detonator.

This series of fuzes may be used on all GP bombs and on the 500- and 1000-lb. SAP bombs.

16. The M115 Series.

For bombing water targets, the Navy decided that the M112 series of fuzes did not provide sufficient safety because the fuze is armed only a few feet directly under the plane. Yet the sensitivity and delay features were required, so that the cocked firing pin and the M16A1 primer detonator were indicated. Therefore, it was decided to combine the mechanical delay arming head assembly of the M100 series with the firing mechanism of the M112 series, and this resulted in the M115 series, consisting of the M115, M116, and M117 fuzes, weighing 2.7, 2.9, and 3.2 lb., and having lengths of 9.6, 12.6, and 16.6 in., respectively.

Even though the gear reduction is 30 to 1, these fuzes arm in 150 to 170 revolutions of the vane, somewhat less than the M100 series, because the arming stem has fewer threads engaging with the plunger. After the arming stem is disengaged from the plunger, the fuzes fire exactly the same as the M112 series. They are used on the same bombs as the M112 series, but the altitude of release must be greater, and because of this the greater safety desired is obtained.

17. The M123A1 Series.

This is a series of special-purpose fuzes to give delays of 1, 2, 6, 12, 24, 36, 72, and 144 hr. The mechanism is shown in Fig. 153. Only one delay is incorporated in each fuze, and the various delays are obtained by varying the chemical in a glass ampoule and the shape and size of a celluloid collar, so that different times are required to soften the celluloid elements and release eight balls which release the cocked firing pin. Fuze action is independent of altitude of release because it requires only 400 ft. of air travel to break the ampoule and start the delay action. The fuze may have drop safety on soft or even normal soil from 1000 ft., but it cannot be guaranteed, as breakage of the ampoule by any means whatsoever starts the delay action.

The older series employed the gear reduction of the M100 series in order to obtain sufficient torque to break the ampoule and to seal the

fuze, the sealing being accomplished by the arming stem screwing down an additional distance after breaking the ampoule, corresponding to about 1000 ft. of air travel. The A1 models omit the gear reduction and have an eight-bladed vane instead of the usual four-bladed vane, in order to counteract the loss of torque due to omitting the gears. Sealing is necessary, particularly for the longer delays, as the fuze might lie in

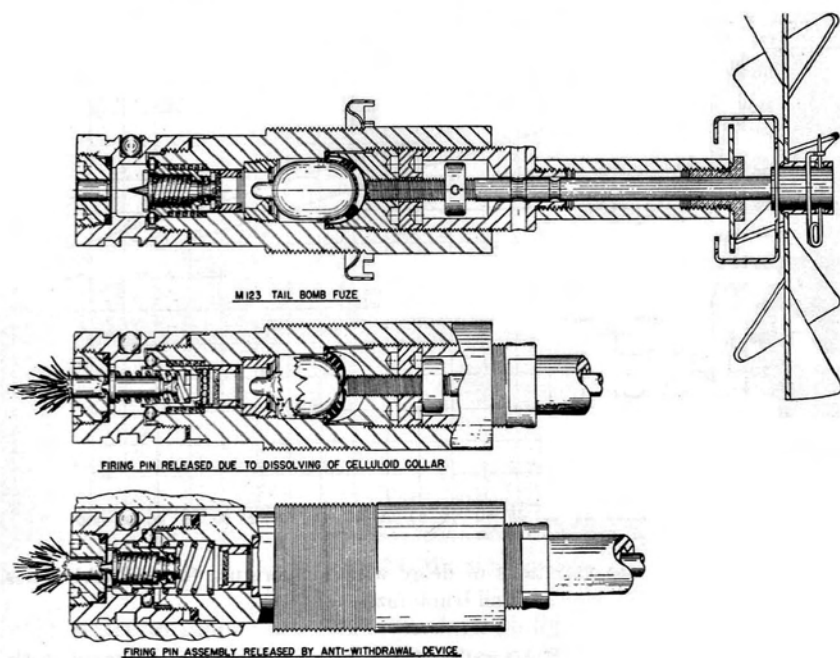

Fig. 153. M123A1 tail bomb fuze.

water or marshy land, and it is important to prevent escape of the solvent or dilution of it by seepage of water into the fuze if the proper delay is to be obtained. The arming head assembly of the M100 series is modified for the M123 series by the addition of an arming block so that the arming wire may be properly withdrawn.

When the celluloid elements are softened so as to release the eight cocked-firing-pin balls, the firing pin is driven by spring action into the detonator. The fuze may also be functioned by the antiwithdrawal device, or booby trap, which consists of a ball in an eccentric raceway or groove around the periphery of the fuze body extension, into which the fuze body proper is assembled by a loose threaded joint. When the fuze is screwed into the adapter booster the ball moves to the deep part of the groove, permitting the fuze to be screwed into the adapter

booster all the way. But if an attempt is made to unscrew the fuze, the ball will jam between the fuze body extension and the side of the extension. After about two turns of the body, the ball supporting the firing-pin sleeve move into the recess created, releasing the firing pin. This fuze is locked to the adapter booster by a lock nut so that vibration will not jar the fuze loose and start booby-trap action. The booby-trap ball is held in place, and the body and body extension prevented

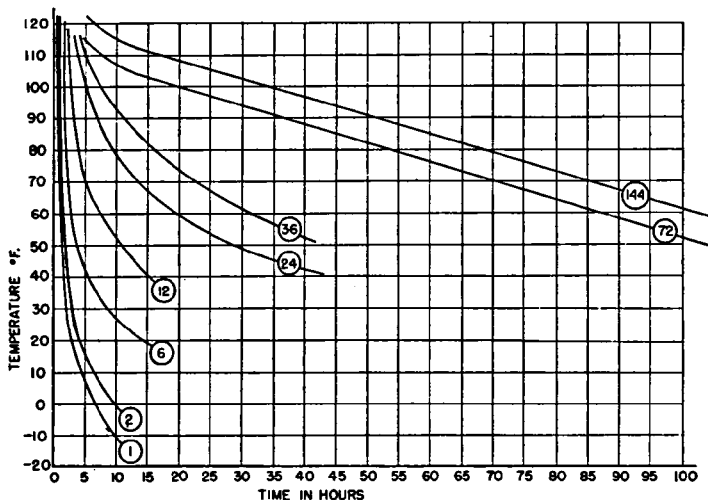

FIG. 154. Approximate variations of delay with temperature for M123A1 series tail bomb fuzes.

from rotating with respect to each other, by a safety clip shipped with the fuze.

Of course, the delays obtained vary greatly with temperature; Fig. 154 shows how each nominal delay is affected by variations in temperature from 25 to 115° F.

18. The M132 Series.

In order to satisfy the requirement for a short fixed delay fuze of about 10 min. minimum at 100° F., the M132 series was developed, which employs the principle of a solvent acting on a celluloid element but with certain modifications of the M123 series. It has the gear reduction arming head assembly, but only about 100 ft. of air travel is required to puncture the bellows and start compression of it, forcing the red solvent out so that it softens a celluloid cylinder in compression. Softening of the celluloid allows the cocked firing pin to release and fire the primer.

The M132, M133, and M134 fuzes have lengths of 9.6, 12.6, and 16.6 in., respectively, and the usual diameter of 1.5 in. for use in the M102 adapter booster. They are similar in appearance to the M123 series except that the M132 series has the head reduced in diameter beyond the lock nut, Fig. 155. The antiwithdrawal devices of the two series are identical, and both have the safety clip to hold the booby-trap ball and prevent relative rotation of the body and body extension.

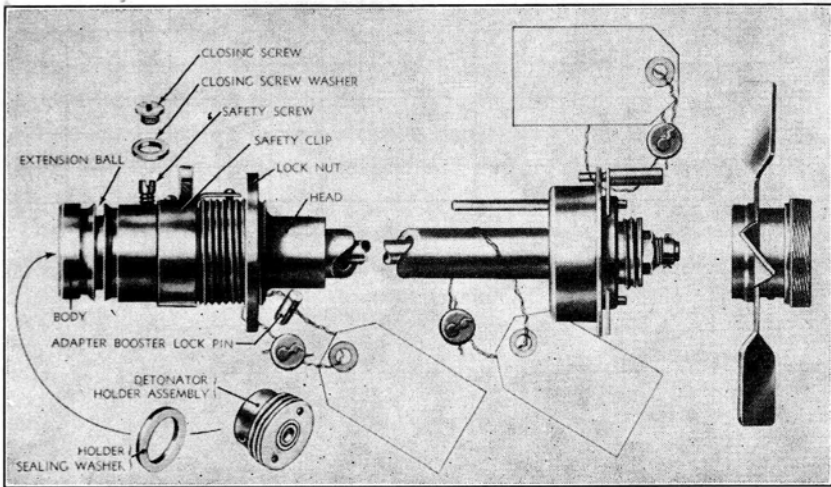

Fig. 155. M132 tail bomb fuze.

In order to relieve the stress on the celluloid element during storage and shipment, a safety screw is located in the fuze body, and its removal causes the compression spring to act against the element, although no movement takes place until the celluloid is softened. The detonator cavity is plugged with cotton so that if the solvent has leaked in shipment it will be stained red. The curve of temperature vs. delay time is shown in Fig. 156.

19. Mechanical Time Tail Fuzes (M152, M153).

For use in certain aimable clusters fuzed from the tail end, several fuzes of the M111 type have been made available. The M152 is a detonator-safe, delayed-arming (260 turns of the vane), tetryl-clay booster fuze having the usual 5- to 92-sec. calibration, and the M153 is similar except for a change in the arming vanes. Both fuzes have vanes with reversed pitch so that rotation will be in the proper direction to arm the fuzes since they are placed in the tail, and the arming assembly bearings are modified to take the reversed thrust.

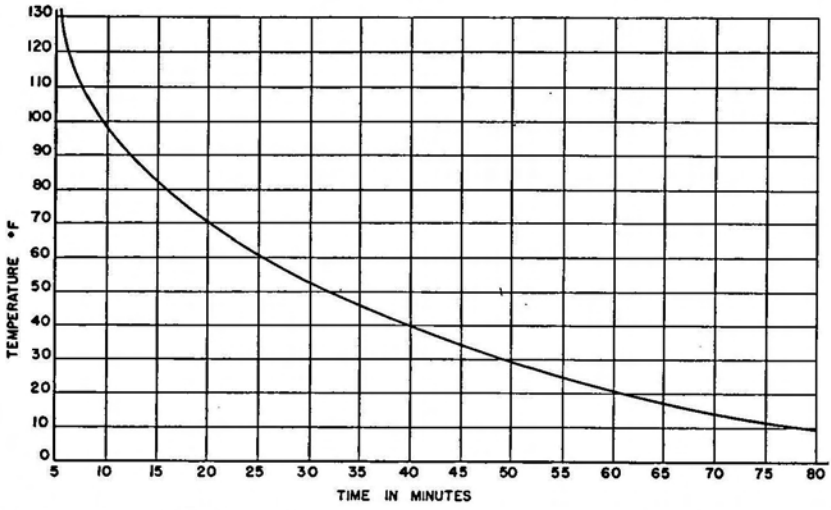

FIG. 156. Approximate variations of delay with temperature for M132 series tail bomb fuzes.

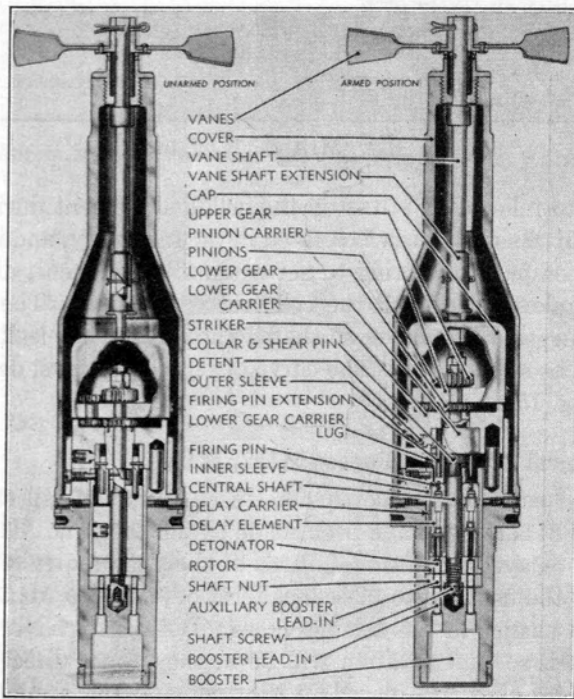

FIG. 157. Mk 228 tail bomb fuze.

20. The AN-Mk 228 Fuze.

This fuze is the only standard tail fuze having detonator safety and 2-in. threads for use with the M115 adapter booster in the 1000- and 1600-lb. AP bombs. It is of the delayed arming vane type with a 0.08-sec. fixed delay and a 23 to 1 gear reduction mechanism in the body of the fuze, is 16.7 in. long, and weighs 10.5 lb. It has a different appearance, somewhat like a bottle, owing to its larger-diameter body and the presence of an integral booster. Arming is accomplished by the striker turning through 175° during the time the sixteen-bladed vane rotates 150 turns to bring the firing-pin extensions into alignment with the two independent firing trains. The firing elements are locked in position, and further forced rotation causes the vane to shear. Upon impact the striker shears a pin and moves forward to drive the firing pins into the primers.

This fuze contains a small round window to permit observation of the condition (armed or safe) of the mechanism. It is shown in Fig. 157.

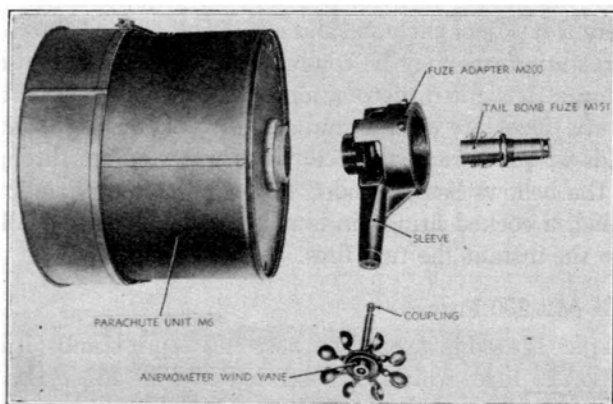

FIG. 158. M151 tail bomb fuze and parachute assembly.

21. Tail Fuze for GP Parachute Bombs.

There has been a trend towards fitting GP bombs with parachutes to eliminate ricochet and secondary impacts. Since the parachute assembly is contained in a large can attached to the tail of the bomb, the usual tail fuze cannot be used. The fuze requirements are cocked-firing-pin action because the velocity of impact is low owing to the parachute, anemometer-vane arming because the fuze is not located on the bomb axis, and an arming stem at right angles to the fuze axis. The M151 fuze is shown assembled to the bomb complete round in Fig. 108 and with vane unassembled and the parachute assembly in Fig. 158.

This fuze has a body like the M112, with cocked firing pin and M16A1 primer detonator, and a head through which a safety pin passes and an arming stem screws. Rotation of the anemometer by air currents passing down the side of the bomb causes the stem to be unscrewed from the head and withdrawn from the plunger. A lock nut is provided to tighten the fuze against the adapter.

HYDROSTATIC BOMB FUZES

22. General.

Hydrostatic fuzes are required for bombs for underwater work; the bombs are either depth or general-purpose bombs. Hydrostatic fuzes are either of the transverse type which fit into a cavity running through the bomb at right angles to its axis, or of the tail type, screwing into the tail of the bomb. The transverse fuzes require two arming wires, one through each of the two heads, and expansion of the bellows in each end is required for complete arming, but transverse fuzes have been replaced by tail fuzes for most depth-bomb requirements. The tail fuzes require rotation of the vane and expansion of the bellows for arming. Hydrostatic fuzes may be combined with impact fuzes so that, if a surface target is sighted, detonation on the surface will be obtained.

Hydrostatic fuzes are armed gradually by the sinking of the bomb, which builds up pressure in the bellows as water enters through ports, and when the bellows has expanded to the point corresponding to the depth setting, a cocked firing pin is released. Arming is really taking place up to the instant the fuze fires.

23. The AN-Mk 230 Fuze.

This tail fuze is used in general-purpose and depth bombs; it functions like the Mk 229 fuze, which is illustrated in Fig. 159. The external appearance of these two fuzes is shown in Fig. 160.

The Mk 229 and Mk 230 fuzes are vane-arming tail fuzes requiring about 110 revolutions of the vane for arming. When the fuze has reached the depth for which set by the handle or setting device on the outside of the fuze, detonation occurs. The fuze is about 2.4 in. in diameter and 16.4 in. long, and it weighs 14.5 lb. It is shaped like a bottle and has a sixteen-bladed vane, which causes the gear train to operate, moving the arming cup upwards, so that the arming pins are ejected. Upon impact, the inertia of the counterbalance weights prevent functioning. As the bomb sinks, water enters the ports and builds up hydrostatic pressure in the bellows, compressing the firing spring. This causes the firing spindle to move down so that the locking balls fly out, releasing the cocked detonator assembly so that it hits the fixed firing pin.

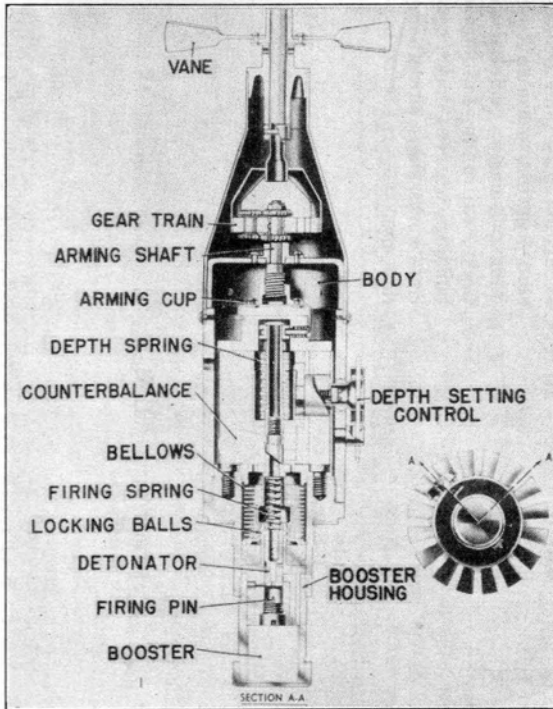

Fig. 159. Mk 229 hydrostatic fuze.

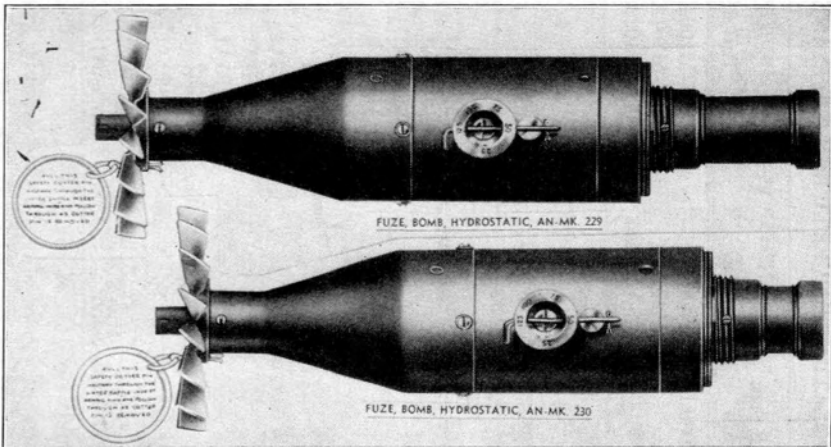

Fig. 160. Mk 229 and Mk 230 hydrostatic fuzes.

RELATIONSHIP BETWEEN TYPE AND SIZE OF BOMB, FUZING, TYPE OF BOMBING, AND TARGET

TYPE AND SIZE OF BOMB.	FUZES		FUZE DELAYS		TYPE OF BOMBING	TARGETS
	Nose	Tail	Nose	Tail		
GP 100-2000 lb.	AN-M103	AN-M100A2	0.01, 0,	0.01, 0,	M, H	Combination blast and demolition against ammunition dumps, hangars, vehicles, oil tanks, railroads, industrial buildings, wharves, docks, concrete works, ships, aircraft carriers, etc.
	M127 *	AN-M101A2	0.025,	0.025,		
	AN-M110A1 *	AN-M102A2	0.10 sec.	0.05, 0.10 sec.		
	M139		Air burst			
	M140					
	M149					
	M135					
	M136					
	None	M112A1	None	4-5 or 8-15 sec.	L	
		M113A1				
	M114A1					
	M115					
	M116					
	M117					
None	M123A1			10 min. to 5 days	L, M, H	
	M124A1					
	M125A1					
	M132					
	M133					
	M134					
AP 600, 800, 1000, None 1400 lb. (M series)		AN-M102A2	None	0.01, 0.025, 0.05 sec.	M, H	Penetration against resistant targets, such as ships and other floating targets, heavy concrete installations, etc.

AP 1000, 1600 lb. (Mk series)	None	AN-MK 228	None	0.08 sec.	M, H	Same as M series AP bombs.
SAP 500, 1000 lb.	Usually omitted	AN-M101A2		0.01, 0.025, 0.05, 0.10 sec.	M, H	Penetration against fairly resistant targets such as light armor, concrete, railroads, light bridges, heavy buildings, etc.
		M112A1 M116		4-5 or 8-15 sec.	L	
		M124A1 M133		10 min. to 5 days	L, M, H	
LC 4000 lb.	AN-M103 AN-M110A1 M127 *	AN-M102A2	0 Air burst	0	M, H	Blast effect against large-area targets, residential areas, large ships, etc.
Fragmentation 4 lb.	M129 M130 M130	None	Air burst, impact, 10, 20, 30 min. antisturbance	None	M, H	Fragmentation effect against personnel, dropped in clusters only.
Fragmentation 20 lb.	AN-M110A1	None	0	None	M, H	Fragmentation effect against personnel, light ground targets, etc.
Fragmentation 23 lb.	AN-M104 AN-M120A1	None	0	None	L	Fragmentation effect against personnel, light ground targets, etc. (parachute).

RELATIONSHIP BETWEEN TYPE AND SIZE OF BOMB, FUZING, TYPE OF BOMBING, AND TARGET—Continued

TYPE AND SIZE OF BOMB	FUZES		FUZE DELAYS		TYPE OF BOMBING	TARGETS [†]
	Nose	Tail	Nose	Tail		
Fragmentation 90 lb.	AN-M103	None	0	None	M, H	Fragmentation effect against personnel, damage to heavier ground targets; parachute for low-altitude work.
	M127 *	None	Air burst	None		
Fragmentation 260 lb.	M151	None	0	None	L	
	AN-M103 M127 *	AN-M100A2	0 Air burst	0	M, H	Antipersonnel and damage to heavier ground targets.
Depth 325, 350 lb.	AN-M103	AN-Mk 224 †	0	25-125 ft. depth	M, H	Underwater targets or floating targets, blast effect.
	AN-Mk 219	AN-Mk 234 †				
Depth 650, 700 lb.	AN-M103	AN-M229	0	25-125 ft. depth	M, H	Same as 325- and 350-lb. depth bomb.
	AN-Mk 219					
Chemical 100 lb.	M108	None	0	None	M	Chemical and smoke bombing.
	M126A1					
Chemical 115 lb.	AN-M110A1	None	0	None	M	Chemical and smoke bombing.
	M127		Air burst			
Chemical, 500, 1000 lb.	AN-M103	AN-M101A2	0	0	M	Chemical and smoke bombing.
	M127 *	AN-M102A2	Air burst			

* With M117 adapter booster.

† Transverse fuze. L, M, H = low-, medium-, and high-altitude bombing, respectively.

PART V
PYROTECHNIC AMMUNITION

CHAPTER 10

PYROTECHNIC AMMUNITION

1. General.

PYROTECHNICS are devices based on fire, smoke, and noise as against those devices based primarily on explosions and detonations. When the Fourth of July was celebrated by "shooting fireworks," display pyrotechnics consisted of the nocturnal portion of such fireworks—sparklers, roman candles, pinwheels and the more descriptive night displays. These same devices, redesigned for specific purposes, adapted to mass production, and engineered to promote uniformity, waterproofness, and certainty of functioning, are useful in modern warfare.

MILITARY PYROTECHNICS are components or devices primarily for either signaling or illumination. SIGNALS are for signaling between aircraft and ground troops, between ground troops themselves, from aircraft to aircraft, and in general between sea, air, and land. In modern war, where movements of great masses of ground troops must be coordinated with air movements, and where aircraft operate by the thousands, communication among all units, whether infantry, artillery, or air force, is essential. Furthermore, these signals must exist in such variety that enough different signals are available to transmit a variety of information and be changed often enough to confuse the enemy and make duplication difficult.

ILLUMINANTS are for the illumination of some object or some area and are required for reconnaissance, observation, bombardment, photography, landing of aircraft and paratroops, disclosure of enemy movements, and a variety of special purposes.

Since peacetime fireworks manufacturers naturally fall heir to military pyrotechnic contracts in wartime, and since many of these operators are small, seasonal, and have grown up with their business over a period of years, they are seldom geared to mass production or accustomed to confining themselves to stringent drawing requirements prescribed by a customer. This is one reason why the pyrotechnics business is popularly supposed to be art instead of science; but military pyrotechnics de-

signers have learned much through the laboratory about the science of pyrotechnics and how to write specifications properly and to compose working drawings of these devices. An outstanding example will be given under "Color Value."

There are potentially as many types of pyrotechnics as there are people, and research is continually improving the quality, stability, and safety of pyrotechnics devices. But let us not forget that we are not trying to please the artistic sense, but to win wars. For this purpose, in July, 1919, a special board of officers convened to study our future

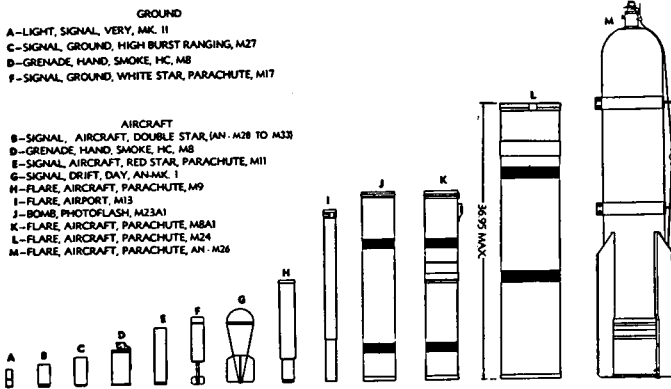

Fig. 161. Comparison of various pyrotechnics.

requirements in pyrotechnics, not only from the standpoint of ground forces, but also with particular reference to the rapidly growing air forces. Our present pyrotechnics system represents a mixture of the findings of this board, changes to these requirements during peacetime, and the requirements of the ground and air forces during World War II. The variety of modern pyrotechnics is shown in Fig. 161. Our present pyrotechnics repertory is a good example of the principle that we seldom really do away with an old type of ammunition but are continually adding to our present types.

2. Classification of Pyrotechnics.

Pyrotechnics may be classified a number of ways, as follows:

According to Tactical Use. Depending upon whether pyrotechnics are for the ground forces or the air forces, they are called **GROUND TYPES** or **AIRCRAFT TYPES**. Some pyrotechnics were originally developed to provide a method of signaling between them, or for the special use of either the ground or air forces.

According to Type of Functioning. Ground and aircraft pyrotechnics may be further broken down in classification as SIGNALS, which produce lights or smokes of various colors and arrangements for the conveyance of messages; ILLUMINANTS, which provide light for an appreciable time, usually longer than signals, or for a very short time for photographic purposes; and MARKERS or SLICKS for marking a spot on the surface of the water for some purpose.

According to Type of Component. Signals and illuminants may be further classified according to the actual type of the component. Thus we have pyrotechnics in the form of flares, signals, cartridges, bombs, mortar shell, artillery shell, grenades, mines, etc., as well as many special sizes and shapes peculiar to pyrotechnic ammunition. Figure 161 shows the great variety of military pyrotechnic devices in use today.

According to Method of Projection. Pyrotechnic devices are projected in a number of ways, and may be classified accordingly. PROJECTOR TYPES are fired from a PROJECTOR, which is a small, smooth-bore, mortar-type device used primarily by ground troops, or from a DISCHARGER, a similar device used by aircraft. PYROTECHNIC PISTOLS, which may be muzzle or breech loaded, are either of the short-barrel VERY PISTOL or the longer-barrel SIGNAL PISTOL type. Other signals are fired from the service rifle by means of the grenade launcher, thus obtaining direction and altitude. Still others, such as signal shell, are fired from a standard mortar, and others are dropped as bombs or thrown as grenades. Some signals are even held in the hand.

According to Speed of Descent. Flares, signals, and other pyrotechnic devices may be of the FREELY FALLING variety or of the PARACHUTE variety, depending on whether or not they have a parachute attached to them to retard their rate of fall. In general, if the burning time is such that the device would fall to the ground while still burning, or if it is desired for some reason to keep the device in the air, a parachute is used.

3. Pyrotechnic Compositions.

PYROTECHNIC COMPOSITIONS are combustible physical mixtures, and their properties must be known to the designer of pyrotechnic devices. These mixtures have characteristics intermediate between those of a mixture, like thermite, and explosives or explosive compounds, as demonstrated in Table 23. Pyrotechnic mixtures contain oxygen for supporting their own combustion, burn progressively, and are usually pressed into candles, so that the candle decreases in length as the mixture burns. The burning is a surface phenomenon. The pyrotechnic designer is interested in certain properties of the mixtures he uses, the most important being candlepower per unit area of burning surface, burning rate,

color of the flame, sensitivity to ignition, impact, and detonation, density of the pressed material, and the candlepower efficiency measured in candlepower-seconds per gram. CANDLEPOWER is usually a military requirement the designer must meet; BURNING RATE determines the length of the candle to obtain the required BURNING TIME; the FLAME COLOR is usually a definite requirement, especially for signals; the DENSITY partly determines the weight of the final component; SENSITIVITY of the mixture to ignition is important for ease of ignition and certainty of functioning, and sensitivity to impact and detonation should be a minimum for safety.

TABLE 23

TYPE OF COMPOSITION	PHYSICAL STATE OF PRODUCTS	PRINCIPAL FORMS	
		OF ENERGY PRODUCED	SPEED OF REACTION
Thermite composition	Solid	Heat	Uniform
Pyrotechnic compositions	Solid and gaseous	Heat and light	Uniform
Explosives	Gaseous	Heat and kinetic	Almost instantaneous or at accelerated rate

Pyrotechnic compositions are made of chemical compounds, the proportions of which are adjusted so as to produce a range of effects, from "dark fire," an element of blinker signals, to the brilliant flash of photo-flash bombs. The mixtures are composed of four types of ingredients as follows:

- (a) Fuel—magnesium or aluminum powder.
- (b) Oxidizer—salts, such as chlorates, perchlorates, chromates, oxalates, nitrates.
- (c) Color intensifier—salts of barium, copper, strontium, sodium; organic dyes.
- (d) Miscellaneous agents—retarding, binding, and waterproofing agents such as asphalt, sulfur, and paraffin; blending and waterproofing agents such as castor oil and linseed oil.

The effect of the color intensifier depends upon whether it is also an oxidizer or not; the peroxides not only intensify the color but also increase candlepower and the burning rate, whereas the chlorides may intensify the color but reduce candlepower and the burning rate. Table 24 shows the effect of adding barium chloride to a barium nitrate, barium peroxide, and aluminum pyrotechnic mixture.

Even though a particular mixture is used, candlepower and burning rate are not assured unless all the other factors are closely controlled. One of these factors is GRANULATION, the size and shape of the individual particles making up each ingredient of the mixture. Differences in gran-

ulation affect the chemical reactions and resulting pyrotechnic values. Without delving into this interesting and complicated subject in detail, this principle can be illustrated by considering a composition of 15% aluminum passing a 200-mesh sieve, 5% sulfur passing an 80-mesh sieve, 78% barium nitrate passing a 100-mesh sieve, and 2% castor oil.

TABLE 24

EFFECT OF ADDING NON-OXIDIZING COLOR INTENSIFIER

	Parts by Weight		
	Barium nitrate	47	47
Barium peroxide	23	23	23
Aluminum	18	18	18
Asphalt	12	12	12
Barium chloride	0	25	40
Candlepower per square inch	2000	1300	700
Burning rate, inches per minute	2.9	2.5	2.4
Color	Greenish white	Green	Intense green

This composition will give about 10,000 candlepower per square inch and a burning rate of 3.2 in./min. If nothing is changed except the granulation of the barium nitrate, say to pass a 200- instead of a 100-mesh sieve, the candlepower will be increased to 12,600 per square inch and the burning rate to 3.4 in./min. Thus it is seen that granulation control is extremely important for uniformity.

Another variable is **LOADING PRESSURE**, which affects the pyrotechnic values, as can be seen by inspection of Table 25. This increase in candle-

TABLE 25

EFFECT OF LOADING PRESSURE ON CANDLEPOWER AND BURNING RATE

Loading Pressure lb./sq. in.	Candlepower per Square Inch	Burning Rate in./min.
2,600	165,200	14.3
8,000	175,600	13.3
16,000	202,200	12.7

power per square inch holds true for magnesium compositions, but for aluminum compositions not much change in candlepower per square inch is expected with changes in loading pressure. Note that the candlepower increases and the burning rate decreases as the loading pressure is increased, as might be expected, because, with the more dense composition resulting from the higher loading pressure, higher candlepower per unit area and a somewhat slower rate are usually obtained. Pyro-

technic values may also change with the diameter of the burning area, as shown in Table 26. The effects may not be the same with all compositions, however; with some compositions candlepower per unit area and burning rate may increase with increase in candle area. In the event that the relationship in Table 26 holds true we see that an increase in the diameter of the candle will require an increase in the loading pressure if the candlepower per unit area is to be maintained. Of course, the reason for increasing the diameter may be to increase the total candlepower.

TABLE 26

EFFECT OF DIAMETER OF CANDLE ON CANDLEPOWER AND BURNING RATE

Burning Area sq. in.	Candlepower per Square Inch	Burning Rate in./min.
2.7	165,200	14.3
5.0	145,200	13.9
10.8	132,000	13.4

The VISIBILITY of a pyrotechnic device depends on the candlepower, the color, and the weather, assuming a given observer. At 1468 yd. on a clear dark night, the minimum candlepower for bare visibility (greater for the shorter-wavelength colors, as they are absorbed by the air more quickly) is about as follows: red, 0.09; amber, 0.18; white, 0.23; green, 0.25. These values will be increased 3000 to 5000 times for vision on a clear day. The weather is one of the uncontrollable and unpredictable variables in pyrotechnic work, and one of the greatest causes of mistaken signals, with resultant loss of men, material, and ground. But the more efficient and uniform we make our pyrotechnics, the less chance for such costly errors, and the pyrotechnic designer always has this challenge before him.

The purpose of adding linseed oil or castor oil is partly to aid in binding and partly to coat the individual particles of the fuel, particularly magnesium. Moisture is very detrimental to pyrotechnic compositions, and in the metallic fuel oxidizes because of the presence of moisture it will affect not only ignition but candlepower and burning time. Strictly speaking, the coating of the fuel particles does not make the composition waterproof, as waterproofing is obtained by sealing of the container or signal housing and by proper packing.

4. Pyrotechnic Ignition Train.

The composition is ignited by an ignition train. For a signal fired from a projector, this train consists of a primer containing primer mixture functioned by a firing pin; the "spit" or flash from the primer

ignites the propelling charge and simultaneously ignites a delay powder train; this burns while the signal is gaining altitude; the delay burns through to a black-powder expelling charge which pushes the illuminant assembly out of the signal case and ignites some quickmatch which because of its confinement burns through immediately to the primed fuse of the "first-fire" composition; this first-fire composition is regular composition to which about 25% black powder has been added to assist in ignition of the illuminant and is loaded in the same candle on top of the regular composition. The first-fire composition ignites the regular composition. Figure 171 shows a pyrotechnic ignition train.

Other pyrotechnic compositions may be ignited in other ways, but ignition is almost always from black powder to the first-fire composition.

5. Color Value.

It has long been customary to control the ingredients of a given pyrotechnic composition by specifying the percentages of the ingredients with a fairly small tolerance, in the belief that the manufacturer would obtain the required candlepower and burning times by carefully mixing the prescribed ingredients within the tolerances. It frequently happens that one manufacturer experiences no difficulty in meeting the requirements, while another encounters all kinds of trouble even though his composition is found upon analysis to meet the drawing requirements. Such circumstances give rise to the belief that pyrotechnics is an art instead of a science, because one manufacturer seems to possess the art and another using exactly the same percentages of the same ingredients may not be able to meet the candlepower and burning-time requirements.

Considerable work has been done in an effort to explain this phenomenon, and to make the manufacture of pyrotechnics less art and more science. It has been found that a pyrotechnic ingredient may comply with the requirement as to composition but may be composed of widely differing particle shapes and widely different granulations, and that it is these variations which give the different results of burning times and candlepower. The size and shape of the magnesium and aluminum powders must be controlled if the requirements are to be met, and the granulations of the other powders may also affect the results.

Now, the actual requirements of a pyrotechnic composition are a certain candlepower, burning time, and depth of color, and if these and any other demands are met, the actual percentages of the ingredients is a secondary consideration. It was therefore decided to relax the narrow limits of the proportions of the ingredients, but specify color value, in addition to candlepower, burning time, and requirements as to the nature of the ingredients. The COLOR VALUE of a pyrotechnic composition

of some particular color is the ratio of the total candlepower produced by colored light passing a certain color filter, to the total candlepower of the source. It is determined by actually varying the ingredients of the composition within certain limits until the palest color and the lowest color ratio is obtained. For white compositions the ratio is established by arbitrarily using color filters and specifying at least two maximum color ratios for the white composition, even though the composition does not actually give the appearance of any of these arbitrarily selected colors.

Minimum color ratios have been established for each of the colored pyrotechnic compositions, and they are now specified, along with candlepower and burning time, thus giving the manufacturer more latitude in mixing his ingredients to get the end results.

GROUND PYROTECHNICS

6. General.

Ground pyrotechnics are functioned from the ground and are for the purpose of signaling to ground units or air force units or to illuminate objects or an area.

7. Ground Signals.

Ground signals are fired from a projector or a rifle. There are three distinct series, the M17 through M22 projector series of star signals, the M17A1 through M22A1 rifle grenade launcher series of star signals, and the T38 through T42 rifle grenade launcher series of colored smoke signals.

In both projector and launcher there are two types of stars in three colors, the stars being either of the single variety with parachute or a five-star cluster without parachute. The colors are white, green, and amber. In addition the launcher series contains red stars. Most ground signals are for both day and night use.

Projector Signals M17 through M22. These signals are assembled in a cylindrical case about 6 in. long and 1.6 in. in diameter to which a finned tail assembly is attached, to stabilize the signal in flight, as shown in Fig. 162. The head end of the signal contains the primer. The signal slides down the projector bore of the M1A1, M3, or M4 projectors and is therefore projected tail first; 75 to 100 ft. from the projector the signal turns around, continuing its flight head first. The height of trajectory is about 600 ft., and during flight the 6-sec. delay is burning. At the expiration of the delay, the expelling charge pushes the illuminant assembly out of the signal case by first pushing out a pressed-fit cap in

the end of the case under which is the parachute. The candle with its wood block to which the parachute assembly is attached follows, and of course the empty case falls to the ground. The closing cup in the end is embossed with the signal identification.

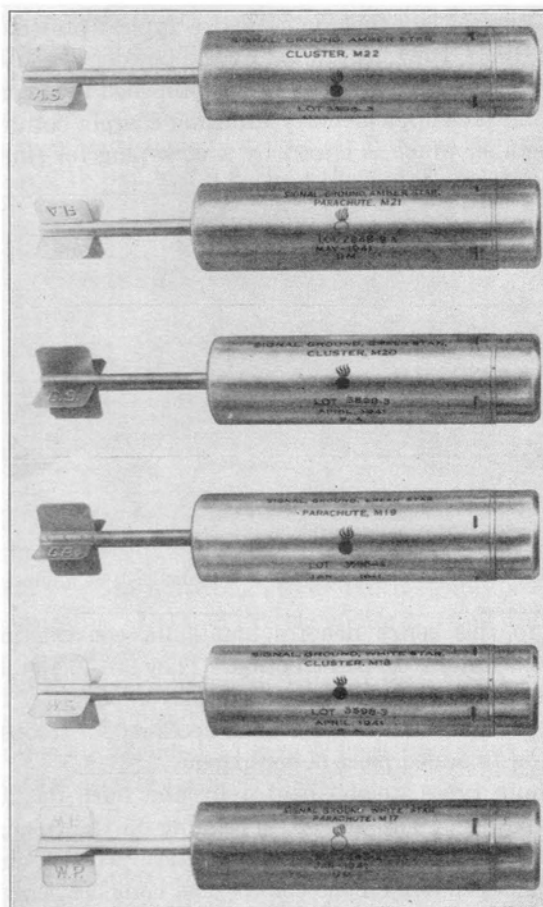

FIG. 162. Projector-type ground signals.

The parachute signals weigh about 1 lb. and burn for 20 to 30 sec. with a candlepower of 4 to 20,000, depending upon the color, while falling about 7 ft./sec.

The five-star cluster types function similarly except that the stars are ignited simultaneously by quickmatch which extends through the axis of the signal to all stars. These cluster signals also weigh about 1 lb.

and burn for 5 to 7 sec. with a candlepower of 2000 to 35,000, depending upon the color.

Launcher Signals, M17A1 through M22A1, M51A1, and M52A1. These cartridges are of the same size as the projector signals, but the tail fin assembly is replaced by a stabilizer tube and round fins similar to rifle grenades. A typical launcher signal and a typical projector signal are shown in Fig. 163. They are ignited by the powder of the special blank cartridge fired in the rifle, or carbine, and propelled by a combination of this powder and the supplementary expelling charge, both expanding in the stabilizer tube, which is closed by a cork plug for shipment. The

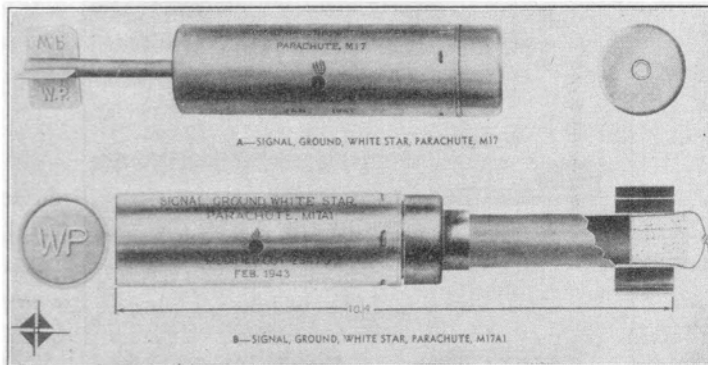

Fig. 163. Comparison of projector- and launcher-type ground signals.

“A1” suffix to this series denotes aluminum construction, and the “A1B2” series denotes steel construction. They are 10.4 in. long overall, contain a 6-sec. delay, and reach a height of 600 ft. The grenade launchers M1, M7, and M8 eliminate the necessity for troops of carrying the projector as an added piece of equipment.

The parachute types weigh about 1 lb. and burn for 20 to 30 sec. with a candlepower of 4 to 20,000, depending on the color; the cluster types weigh about 1 lb. and burn for 5 to 7 sec. with a candlepower of 2000 to 35,000 depending on the color. The launcher series as a whole has the same colors as the projector series, namely, white, green, and amber, plus red.

Colored Smoke Launcher Signals. This is a series of signals similar to the M17A1 launcher series, except that the signals contain a colored smoke composition instead of an illuminant composition, the smoke colors being red, orange, yellow, green, and violet. They have the same appearance as the M17A1 series except that they are 10.2 in. long and 1.88 in. in diameter, and detonate with a sharp noise, caused by the EC blank powder detonator bursting the signal and candle. This detonator

is balanced against the strength of the assembly so that the dye is formed nicely into a puff with persistence of 20 to 30 sec. rather than being scattered too much by the detonation. Of course, the persistence depends on the wind velocity, and the visibility of the colors depends upon climatic conditions, color of the sky background, etc. Colored smoke launcher signals are used primarily by artillery observers to signal or lay in a line of fire.

Data on the grenade launcher ground signals are given in Table 27.

High-Burst Ranging Signal M27. This signal, Fig. 164, was developed, not for signaling, but to simulate the air burst of an artillery shell by producing a smoke puff and a flash at the top of its trajectory, in order

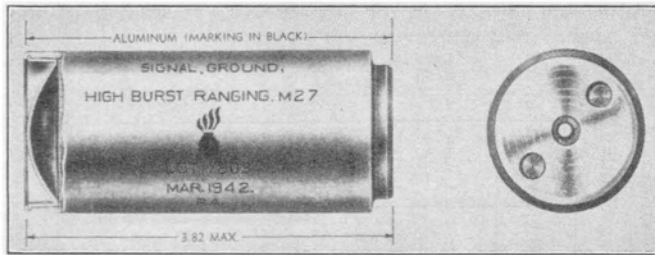

FIG. 164. High-burst ranging signal.

to give artillery crews ranging practice. It is similar to the single star ground signal but has no parachute or tail assembly and is fired from the M1A1 projector. Data on this signal are given in Table 29.

Flash-and-Sound Signal M74. This is a small signal about 3 in. long and $1\frac{1}{2}$ in. in diameter filled with 1 oz. of flash powder (black powder plus aluminum), and fitted with a 2- to 3-sec. delay. It is fired from a pyrotechnic pistol, intended to give a flash and short reports, but no fragments. It is used in training troops.

8. Ground Illuminants.

Ground pyrotechnics which are illuminants consist of the 60- and 81-mm. illuminating projectile, the airport flare, two types of trip flares, and various types of ground flares.

Illuminating Projectiles. The purpose of illuminating projectiles, which are fired from the 60- and 81-mm. trench mortars, is to illuminate the enemy at night, disclosing his movements and making him vulnerable to fire. The 60-mm. shell M83 is fitted with a 14-sec. time fuze, illustrated in Fig. 77, which is ignited by setback after the safety wire is removed. At the end of the delay, the expelling charge blows off the tail and fin assembly and forces out the parachute and candle, igniting

TABLE 27
DATA ON GRENADE LAUNCHER GROUND SIGNALS

Nomenclature	M17A1	M19A1	M21A1	M51A1	M18A1	M20A1	M22A1	M52A1	Colored Smoke Signals T38-T42				
	Para- chute White 5.5 20-30 600 7 20 2 to 2½ 16 10.4 1.88	Para- chute Green 5.5 20-30 600 7 5 2 to 2½ 16 10.4 1.88	Para- chute Amber 5.5 20-30 600 7 4 2 to 2½ 16 10.4 1.88	Para- chute Red 5.5 20-30 600 7 20 2 to 2½ 16 10.4 1.88	Clus- ter White 5.5 20-30 600 Free 18 * 3½ to 4 17 10.1 1.88	Clus- ter Green 5.5 20-30 600 Free 7 * 3½ to 4 17 10.1 1.88	Clus- ter Amber 5.5 20-30 600 Free 2 * 3½ to 4 17 10.1 1.88	Clus- ter Red 5.5 20-30 600 Free 35 * 3½ to 4 17 10.1 1.88	Smoke puff Red 5.5 20-30 600 None No light produced 3½ 16 10.2 1.88	Smoke puff Orange 5.5 20-30 600 None No light produced 3½ 16 10.2 1.88	Smoke puff Yellow 5.5 20-30 600 None No light produced 3½ 16 10.2 1.88	Smoke puff Green 5.5 20-30 600 None No light produced 3½ 16 10.2 1.88	Smoke puff Violet 5.5 20-30 600 None No light produced 3½ 16 10.2 1.88
Type of signal													
Delay time (sec.)													
Burning or persistence time (sec.)													
Projection height (ft.)													
Rate of fall (f/s)													
Minimum candlepower (thousands)													
Illuminant weight (oz.)													
Complete weight (oz.)													
Length (in.)													
Fin diameter (in.)													

* For each star of the five-star assemblies.

the candle at the same time. The candle burns for about 25 sec., emitting about 145,000 candlepower, while falling at the rate of about 10 ft./sec. The shell is 14.28 in. long and 2.3 in. in diameter, weighs 3.7 lb. and has an altitude of about 800 ft. at 1000 yd. range. It is shown in Fig. 165.

The 81-mm. illuminating projectile M301 is similar, except that the M84 time fuze, described in Chapter 6, is adjustable from 5 to 25 sec. and, the candle being larger, burns for 60 sec. at about 275,000 candlepower.

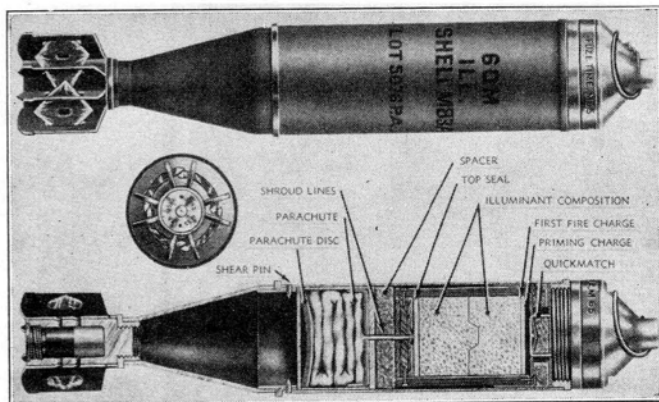

FIG. 165. 60-mm. illuminating projectile.

Trip Flare M48. This flare is constructed like an antipersonnel mine of the "bouncing betty" type, the fragmentation projectile being replaced by a flare, which is projected upwards when the standard firing device is actuated by pressure of 20 to 30 lb. or by a pull of 4 to 6 lb. on the pull device. It is buried flush in the ground or just below the surface or hidden by camouflaging, and is intended to give warning of enemy marauders or infiltration by hostile troops. The primer, igniter, and relay charge flash to the base propelling charge of 75 grains of black powder, forcing the flare assembly to a height of 300 to 500 ft. and at the same time igniting a 3-sec. delay fuze in the base of the flare. This delay charge in turn ignites an expelling charge which expels the parachute assembly and ignites the flare, which burns for about 20 sec. with a candlepower of 110,000, illuminating a circle of some 300-yd. radius. It is shown in Fig. 166.

Trip Flare M49. This flare is for the same purpose as the M48 flare but is of the hand grenade type, fitted with a mounting bracket for ready attachment to a pole or tree or any convenient mounting. It is functioned by the trip wire being pulled or cut, the fuze being similar to a

grenade fuze without delay which ignites the flare instantaneously. The flare burns in position as mounted for about 60 sec. at 40,000 candlepower, is about 3.8 in. long and 2.5 in. in diameter, exclusive of bracket, and is shown in Fig. 167. It can be used as a signal, flare, or incendiary.

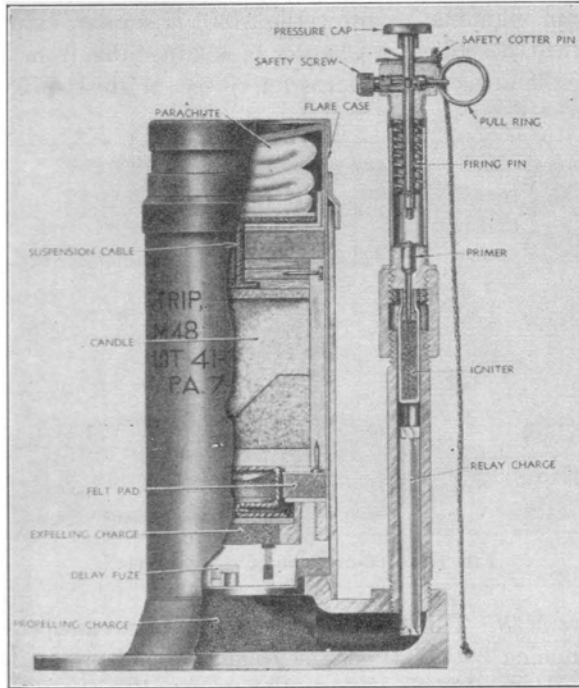

FIG. 166. M48 trip flare.

Both the M48 and M49 flares are shown in external appearance in Fig. 168.

Airport Flares. The purpose of airport flares is to provide illumination for aircraft landings at emergency fields or recently captured fields, before regular electrical illumination can be installed.

The M13 airport flare is a cylinder 23 in. long and 1.75 in. in diameter, with a top cover sealed with a strip of adhesive and a 7-in. hollow cylinder at the other end. After the tape is removed and the flare slipped over a rod or stake, it is ignited by pulling a lanyard attached to the ignition wire, which ignites the candle instantaneously, giving 40,000 candlepower for 3 min.

To meet the demand for a high-candlepower flare for illumination of airports, the M76 airport flare was developed having the approximate

light output of the M26 bombardment flare, namely, 700,000 candlepower, but with a burning time from 5 to 7 min. It consists of a large candle containing about 23 lb. of illuminant composition ignited by 6 oz. of first-fire composition which in turn may be ignited either electrically

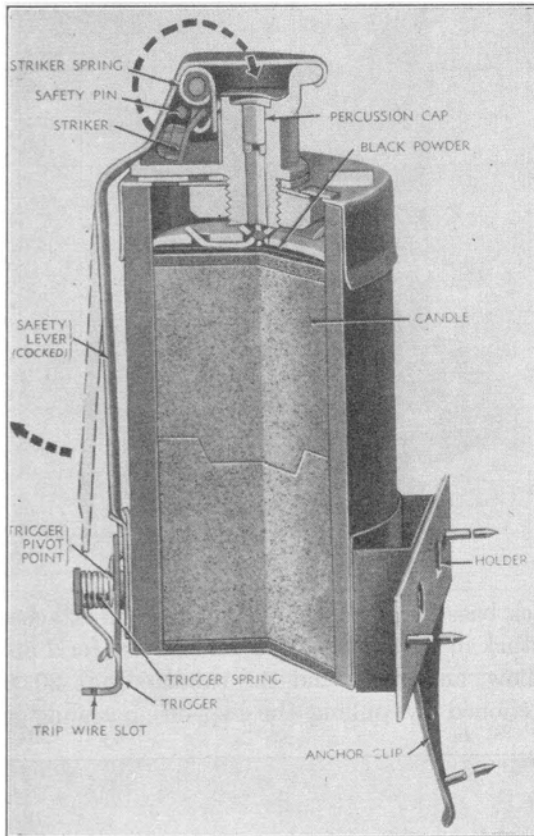

FIG. 167. M49 trip flare.

by a squib or mechanically by a spring release pin hitting the primer when a pull wire is withdrawn. It is fitted with a stand consisting of four collapsible steel legs which are supported on the ground. The flare, Fig. 169, is about 31 in. long and $4\frac{1}{2}$ in. in diameter, and the candle requires pressing in about nineteen increments. This flare may also serve as a beacon for guiding aircraft to the proper landing strip during either day or night.

A high-candlepower flare like this allows use of a newly captured or hastily constructed field at the earliest possible moment.

Fusee-Type Flares. A series of ground flares of the commercial fusee type have been developed which consist of a paper cylinder $7\frac{3}{4}$ in. long and $1\frac{3}{4}$ in. in diameter containing pyrotechnic composition and attached

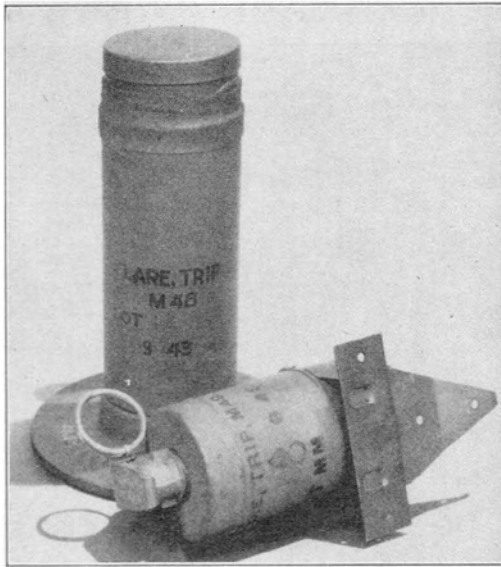

FIG. 168. M48 and M49 trip flares.

to a wood block base to which a 20-penny spike is attached so that the flare may be stuck in the ground. The flares burn for 2 min., the colors being red, yellow, and green and the candlepowers 20,000 or 35,000. They are functioned by pulling the cap off, revealing a match-head



FIG. 169. High-candlepower airport flare.

composition which is ignited by the scratching surface of the cap. These flares are used for troop recognition purposes or to indicate to cooperating air elements a line of position or direction.

TABLE 28
CHARACTERISTICS OF GROUND ILLUMINANTS

Designation		Minimum Candle- power	Burn- ing Time sec.	Mini- mum Color Value	Illumi- nant Weight	Com- plete Weight lb.	Length in.	Diam. in.	Delay Time sec.	Rate of Fall ft./sec.	Approx- imate Altitude ft.	Use
Num- ber	Name											
M83	60-mm. illumina- ting shell	145,000	25	Yellow .034	7.8 oz.	3.7	14.3	2.3	14	10	400	Illumination of enemy territory
M301	81-mm. illumina- ting shell	275,000	60	Yellow .032	23.2 oz.	10.69	22.5	3.2	2-25	10	800	Illumination of enemy territory
M48	Trip flare	110,000	20	Yellow .034	7.9 oz.	5.06	8.6	2.4	3	10	300-500	Warning of enemy approach
M49	Trip flare	40,000	60	Yellow .038	11 oz.	1.44	3.8	2.5	None	..	None	Warning of enemy approach
M13	Airport flare	40,000	180	White light	31 oz.	2.3	23	1.8	None	..	None	Improvised airport illumination
M76	Airport flare	700,000	5-7 min. 120	Yellow .030	23 lb.	27.1	31	4.5	None	..	None	Improvised airport illumination
	Ground flare	20,000	120				7.8	1.8	None		None	Troop recognition
	Ground flare	red 25,000	120				7.8	1.8	None		None	Troop recognition
	Ground flare	yellow 35,000	120				7.8	1.8	None		None	Troop recognition
	Ground flare	green 85	120				16	0.9	None		None	Troop recognition
M72	Fusee	40,000	20 min. 55	Red .45	9 oz.	10.3 oz.	4.4	2.4	2		None	Front-line illumina- tion of enemy
	Hand illumina- tion flare	25,000	90			1.3	4.4	2.4	2		None	Front-line illumina- tion of enemy
	Hand illumina- tion flare	800,000				1.3	4.4	2.4	2		None	Warning of enemy approach
	See suspen- sion flare					18	24	4.3	None		None	Warning of enemy approach

The M72 red fusee, Table 28, operates similarly but is about 16 in. long including the spike, is about $\frac{7}{8}$ in. in diameter, and burns for 20 min. It is ignited by removing the cap and scratching the primer charge under the cap with the striking charge on the cap. This fusee is used to outline air strips.

Hand Illumination Flares. By modifying the M49 trip flare by omitting the bracket, replacing the top cap with a bottom cap, and adding a 2-sec. delay of the grenade-type igniting fuze, there result two hand illumination flares. One burns for 55 sec. with about 40,000 candlepower, similar to the M49 flare, but the other burns for 90 sec. with a candlepower of 25,000. Both are $4\frac{3}{8}$ in. long by $2\frac{3}{8}$ in. in diameter and weigh 1.3 lb. They may be thrown by hand, functioning like a standard grenade, or they may be launched from the rifle by means of the chemical adapter. The tree-suspension device may be used, which pulls a cord out of a tube, so that the cord and the adapter become entangled in foliage, thus causing the flare to burn off the ground.

In front-line investigation of suspicious noises these flares are thrown or launched ahead of troops.

Tree-Suspended Flare. This flare is composed of the candle of the M26 aircraft parachute flare, modified for tree suspension and electrical or pull ignition. It is 24 in. long and $4\frac{1}{4}$ in. in diameter, emits 800,000 candlepower, and weighs 18 lb. Two 12-in. cables replace the shock absorber of the M26 flare, so that the flare may be suspended as high above the ground as possible. It may be used to investigate suspicious noises at night near the front lines, if the site is accessible before or during lulls in enemy activity. The hand illumination flare has the advantage of being able to be propelled into the area to be illuminated, but it has less candlepower.

AIRCRAFT PYROTECHNICS

9. General.

Pyrotechnics for aircraft use include signals similar to ground signals except that they are fired from a pyrotechnic pistol, sometimes mounted in the side of the ship; flares which may be dropped like bombs with or without delayed parachute opening; photoflash bombs for aerial photography; and certain target-identification pyrotechnics used in connection with bombing.

10. Aircraft Signals.

The two distinct types of aircraft signals are cartridges, an older type having an aluminum case with no rim beyond the diameter of the ex-

pendable case for firing from the muzzle-loaded M2 pyrotechnic pistol, and the newer type having a heavy cardboard case with a projecting rim for firing from the breech-loaded M8 pyrotechnic pistol. The first type, having an annular groove near the base for holding the signal in the pistol, is known as the rimless type and can be fired from either the muzzle- or breech-loaded pistols. The second, known as the cartridge type because of similarity to shotgun shell, can be fired only from the breech-loaded pistol. The rimless series is shown in Fig. 170 and the cartridge type in Fig. 174.

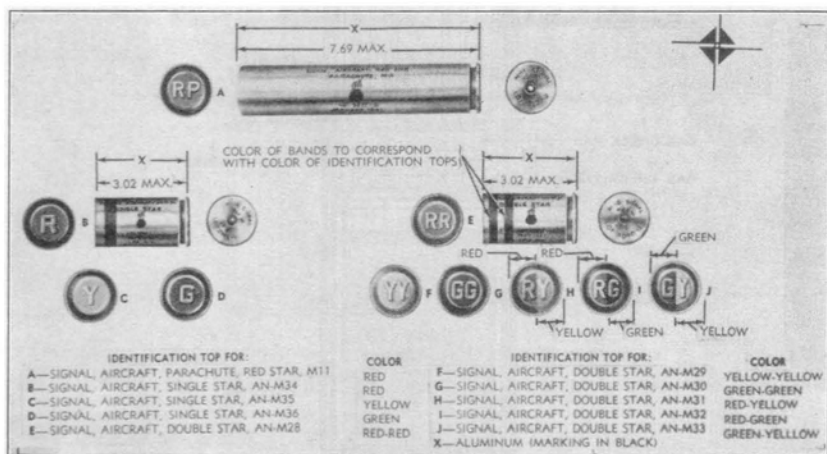

FIG. 170. Rimless-type aircraft signal.

Aircraft signals serve a variety of purposes: for signaling distress from grounded planes, for regular or emergency identification of aircraft, for marking a reference point on the surface of the water, for obtaining information on the drift of the plane or the wind direction, and for illuminating the surface of the water before landing.

Rimless-Type Aircraft Signals. The red star aircraft signal M11, Fig. 171, contains a red star and parachute in a rimless aluminum case about $7\frac{3}{4}$ in. long with a standard diameter of $1\frac{9}{16}$ in., weighs 9.6 oz., and is fired from a grounded plane as a distress signal to a rescuing plane or party. When the signal is fired from the M2 or M8 pistol, the 31-grain propelling charge projects it to a height of about 150 ft. and ignites a 2.5-sec. delay fuze which in turn ignites the expelling charge to expel the signal from the case and ignite the candle at the same time. It burns for 30 sec. at about 20,000 candlepower.

The M10 white star parachute signal, the M15 white star blinker parachute signal, the M16 green star blinker parachute signal, and the

M14 red star cluster signal are similar to the M11 distress signal but are now obsolete.

In addition, the AN-M28 through AN-M33 series of aircraft signals is similar in having aluminum rimless cases, about 3 in. long, but they are of

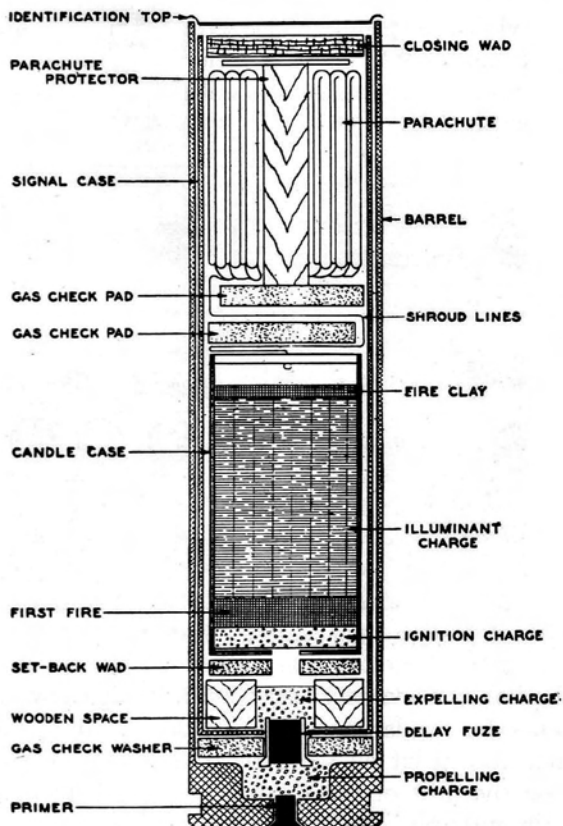

FIG. 171. M11 aircraft signal.

the double-star type without parachute. The stars are either red, yellow, or green, and the two may be of the same color or different colors. They burn for 7 sec., are fired from the old M2 pistol, but have been replaced by the cartridge type. The construction of the double-star signal is shown in Fig. 173.

The AN-M34 through AN-M36 series is very similar to the double-star AN-M28 series except that they are single-star signals; they also have been replaced by the cartridge type. The construction of the single-star signal is shown in Fig. 172.

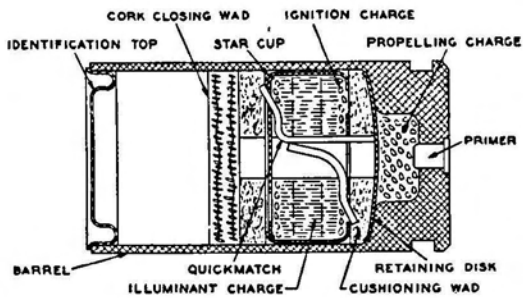

Fig. 172. Single-star aircraft signal (rimless type).

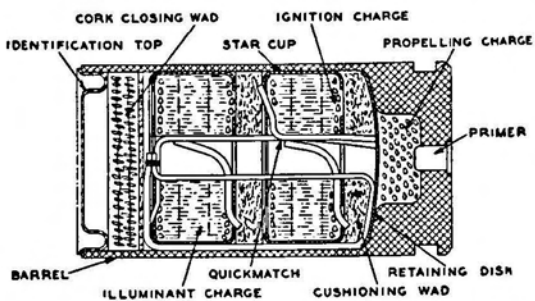

Fig. 173. Double-star aircraft signal (rimless type).

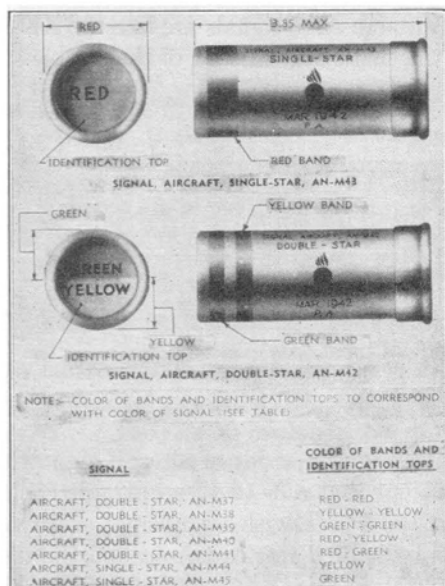

Fig. 174. Cartridge-type aircraft signals.

Cartridge-Type Aircraft Signals. The AN-M37 through 42 final type series of aircraft signals are composed of cylindrical paper shell cases with metal or plastic heads containing a primer, the other end being closed with a cardboard wad. Although the color of the stars is clearly marked on the signals, there is no method of identification at night like the metal case signals with embossing identification on the end cup.

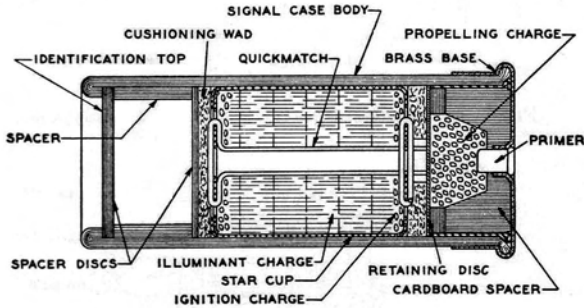

FIG. 175. Single-star aircraft signal (cartridge type).

The signals are 3.85 in. long by 1.54 in. in diameter, burn for 7 sec., and are of the double-star type of combinations of red, yellow, and green. They have a rim at the metal end and are called cartridges because of their similarity to shotgun cartridges. They are fired from the M8 or other breech-loaded pistol.

The AN-M43 through M45 signals are like the AN-M37 series except that they are of the single-star instead of the double-star type.

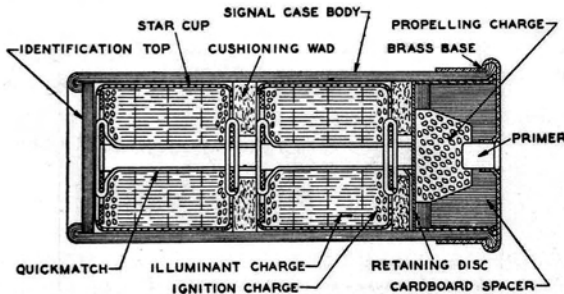

FIG. 176. Double-star cartridge-type aircraft signal.

The AN-M53 through 58 series of aircraft signals are similar to the AN-M37 series except that a 3- to $4\frac{3}{4}$ -sec. tracer has been added. The double stars burn 3 to $4\frac{1}{2}$ sec. with a candlepower between 20 and 48,000, depending on the individual star or tracer, and the tracer has a candlepower of 18 to 30,000. The construction of both the single- and double-star signals is shown in Figs. 175 and 176.

Drift Signals and Slick Markers. It is essential that aircraft be able to determine their drift with respect to their course at any time the pilot or navigator desires; drift signals or slick markers serve this purpose. They are dropped on the water so that a spot is marked for reference. By day the spot is marked by means of a slick-producing material, the device being called a SLICK MARKER; by night the spot is marked by illumination of a spot on the water, the device being called a DRIFT SIGNAL. Of course, these devices have other applications. The drift signal will serve to mark any object or area which the aircraft crew

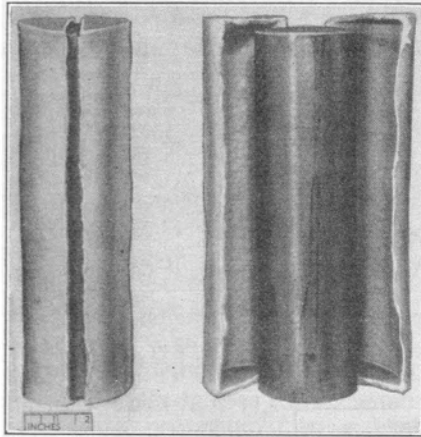

FIG. 177. M59 slick marker.

desires to call to the attention of surface vessels or to determine the wind direction before landing or to illuminate the surface of the water for night emergency landings. The slick marker will mark a point on the surface for the information of surface vessels or will provide a practice bombing target on the water or will spot the drift of the plane.

1. Day drift signal AN-Mk 1. This drift signal is really a slick marker and is used by both the Army and Navy to provide a bronze slick on the surface of the water. It consists of a streamlined paper shell containing metallic powder which breaks on impact to produce the slick. The shell is made of waterproof paper $\frac{1}{16}$ in. thick with a hemispherical nose $3\frac{1}{2}$ in. in diameter. The body is 10 in. long, tapers to a point, and is fitted with a tail of four integral paper fins to give flight stability. It weighs $2\frac{1}{2}$ lb. and is dropped by hand.

2. Slick marker, AN-M59. This slick marker, Fig. 177, has the same purpose as the AN-Mk 1, but it produces a yellow-green fluorescent slick, has a non-streamlined cylindrical body of brittle "Wilsonite" filled with 900 cc. Uranine dye, and is protected by the two papier-mâché

cylinders. These cylinders are automatically retained in the slick dropper, or if the markers are dropped by hand the covers may be removed by hand, though they need not be, as the case shatters completely on impact, producing a slick which persists for 2 hr. and can be seen for 10 miles at 3000-ft. altitude. The marker weighs 2.9 lb. and is $3\frac{3}{8}$ in. in diameter and $10\frac{7}{8}$ in. long. It is of interest to note that one of the principal problems encountered in the course of the development of the marker was to make the case strong enough to withstand the internal pressure at high altitudes.

3. Night drift signal AN-Mk 4. This signal is thrown over the side of the plane, preferably in a horizontal position with nose end forward like a small bomb, which it resembles; upon impact with the water, it

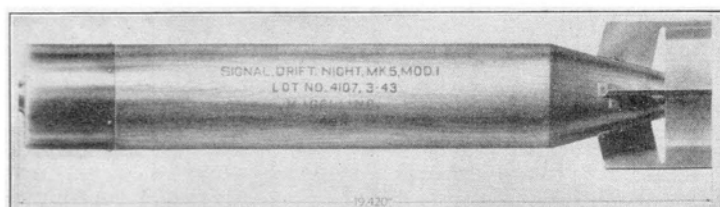

FIG. 178. Night drift signal.

produces a bright flame 12 to 15 in. high and a white smoke cloud. In clear weather the flame can be seen at night a distance of 6 to 7 miles, but it might not be seen in daylight; the white smoke makes daytime signaling possible. The signal consists of a bronze die-cast nose with water-impact fuze having a lug to prevent the signal from striking bottom, a wood body tapered at the fin end and containing the pyrotechnic mixture inside a lead or zinc tube for protection, and a sheet-metal tail assembly. Upon water impact, a paraffined sealing disc breaks at the same time a firing pin is driven into the primer, igniting the 8- to 12-sec. delay, during which time the signal returns to the surface and rights itself, and at the expiration of which the pyrotechnic mixture is ignited. When sufficient pressure is developed, a cap is forced out the tail end of the tubular body cavity and the mixture bursts into flame, burning for about 3 min. Good performance is obtained at altitudes of 500 ft. The signal weighs 2 lb. and is 13.6 in. long and 2.9 in. in diameter.

4. Night drift signal AN-Mk 5, Mod 1. This signal, shown in Fig. 178, is similar in functioning to the AN-Mk 4 except that the die-cast nose is flat and the signal weighs 4 lb., is 19 in. long, and burns for 15 to 17 min. after a 9-sec. delay. It can be used at altitudes less than 500 ft. as its size and shape produce nose impact and proper functioning even at altitudes as low as 100 ft.

11. Aircraft Illuminants.

Aircraft Flares. The aircraft bombardment flare is designed to provide illumination for night bombardment. Daylight bombing has the advantage of good target visibility and greater accuracy, but night bombing has the advantage of comparative safety, and bombardment flares are necessary to light the target area. In order that the bombardier and plane may be shielded from the glare and light from the flare, an umbrellalike shade is sometimes put over the burning candle.

1. Aircraft bombardment flare AN-M26. This is the largest bombardment flare dropped from a plane; it weighs 52.5 lb. and looks like a bomb

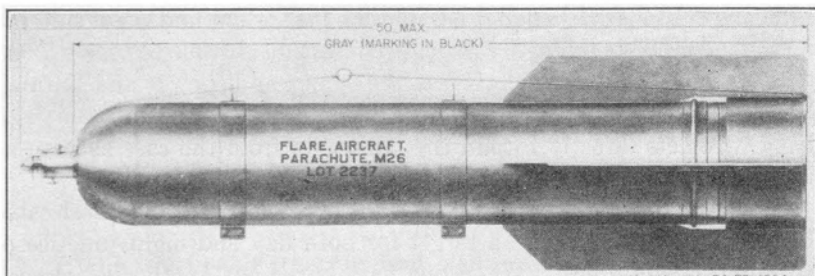

FIG. 179. M26 bombardment flare.

with fins and mechanical time fuze M11. It is 50 in. long, 8 in. in body diameter, and 13.5 in. in diameter across the fins. It is shown in Fig. 179. A delayed-opening parachute supports the flare, which burns for 3 to 3.5 min. with a yellowish light, minimum candlepower being 800,000.

Since the M11 fuze may be set as high as 90 sec. the M26 flare may be used for high-altitude bombardment at speeds up to 300 mi./hr.

When released armed, the fuze arming wire is withdrawn, starting the clockwork delay mechanism, and the hand wire attached to the plane breaks the seal wire, pulling the hang wire container from the flare case. This action pulls out the tear wire attached to the hang wire, pulling out the tear cord and the sleeve with its shrouds. The detachable cover lock is removed by a cord attached to the shrouds of the sleeve, but the cover-releasing cup and cover assembly remain locked in the flare case.

The tear wire is broken after the flare falls a distance equal to the sum of the length of hand wire, tear wire, tear cord, sleeve, and sleeve shrouds, making the flare freely falling. At the expiration of the set time, the black-powder fuze booster charge is ignited, pushing the cover-releasing cup from the cover assembly and allowing the spring-loaded detents to disengage, which makes the cover assembly free from the flare case.

The pullout cord attached to the cover and the parachute then pulls the parachute out, and the shade and illuminant assembly follow. As the parachute leaves the case the pullout cord is broken, separating parachute from sleeve; the shock of parachute opening is taken by the metal shock absorbers, lest the parachute break. The suspension cable pulls the ignition wires through the igniter which sets off the delay element and ignites the quickmatch, first fire, and candle. The gases from the candle force off the shade rib retainer, which are spring-loaded, and the shade opens like an umbrella. The flare and parachute shade drop at about 12 ft./sec.

2. Bombardment and observation flare, M24. This flare preceded the M26 and is similar although it has no time fuze or fins and is not suitable for high-altitude bombing. It is released from an altitude of 2500 to 3000 ft. at not over 200 mi./hr. It has the same candlepower and burning time, but is 37 in. long and 8 in. in diameter, and weighs 47 lb. The hang wire acts directly to pull the parachute from the case as soon as the flare is released.

3. Tow target flare, M50. This flare is towed on a long steel cable behind a plane to provide a target for both day and night practice of anti-aircraft gun crews. When one flare burns out another is released from the plane; it slides along the cable until it pushes off the old flare and ignites itself because the sudden stop jerks the suspension cable taut, pulling out the closing plug and pulling the ignition wire through the primer. This action ignites the quickmatch, which burns through the central tube to the rear of the flare, blowing off the base cap and igniting the flare. The yellowish light of this 60,000-candlepower flare burns for 6 min. but neither obscures the navigation lights of the plane nor necessitates filters in fire-control instruments.

This flare, Fig. 180, is essentially a cylindrical laminated paper case with sheet-metal caps on both ends, the head and cap being sealed with adhesive tape. Under the nose cap, the case is closed with a wooden cap fastened by four nails that pull out when the plug is jerked out. This takes up the slack in the cable under the wooden plug and pulls the ignition wire through the primer mixture. The flare is 22.85 in. long and 2.5 in. in diameter and weighs 7.13 lb. The towline may be 6000 ft. long, and a slant range and altitude combination is satisfactory up to 20,000 yd. The flare should not be released at speeds over 150 mi./hr. or when the plane and cable are turning. Once the flare is burning, however, the speed of the plane may be increased.

4. Colored towed flares. In 1944 mass concentrations of planes for night aerial attacks had grown so heavy that some method of identifying group leaders in the air was required. As a considerable time is required

to get a quantity of planes in the air, some signal had to be provided for each group so that it could rally around its leader. The requirement was a flare, available in as many colors as possible, burning for about 5 min. with a minimum of 20,000 candlepower and capable of being produced from materials on hand within a few weeks.

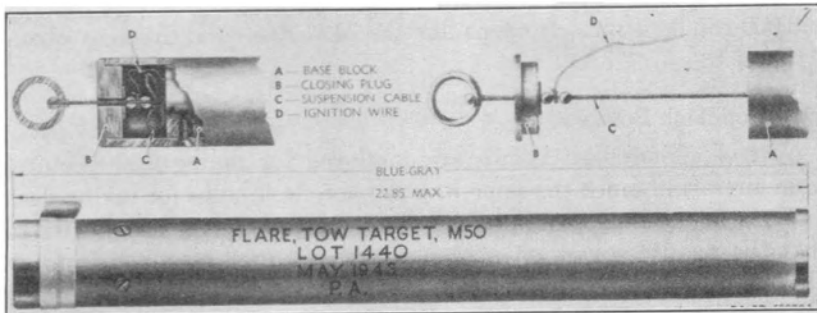

FIG. 180. M50 tow target flare.

To meet this requirement, the M50 tow target flare was modified for use on a short cable from the lead plane, and amber, green, and red flares of 20,000, 90,000, and 225,000 candlepower, respectively, were developed to burn 5 min. They are 23.3 in. long and 4.5 in. in diameter and weigh 15 lb.

Reconnaissance and Landing Flares. The purpose of flares of this type is to illuminate an area at night either to obtain information or for an emergency landing; landing flares are also suitable for reconnaissance.

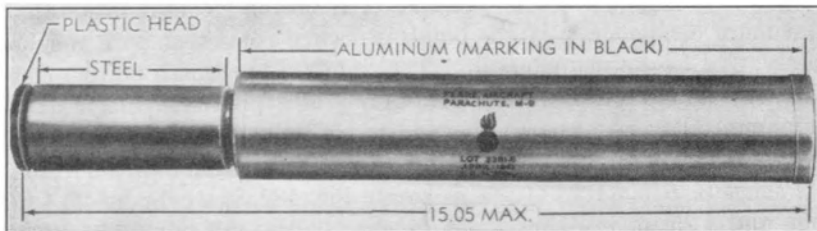

FIG. 181. M9A1 reconnaissance flare.

1. Aircraft parachute flare, M9A1. This flare, Fig. 181, was developed primarily to satisfy the requirement for a small parachute flare for reconnaissance purposes. It is essentially a cylinder, 15 in. long and 2 in. in diameter, being reduced in diameter at the base to fit the M8 pistol; it weighs 2.1 lb. and burns for 1 min. with a white light at 60,000 candlepower. After discharge from the pistol, the fuze burns for 2.5 sec.,

after which the expelling charge pushes the flare and parachute from the case and ignites the flare, which falls at about 7 ft./sec.

2. Aircraft parachute flare, M8A1. This is a somewhat larger and higher-candlepower flare, similar to the M24 but unshaded, and intended for emergency night landings. It is 25.5 in. long and 4.5 in. in diameter, weighs 18 lb., and burns for 3 min. with a yellowish light at 350,000 candlepower. It opens like the M24 flare, and drops at about 8 ft./sec.

12. Photoflash Bombs.

General. Photoflash bombs are employed for taking flash pictures from aircraft in much the same way as photoflash bulbs for taking flash pictures in the home, except that the candlepower is much greater so that the picture covers miles of territory and may be taken from an altitude of several thousand feet. They are called bombs because they are carried in and released from planes like bombs, and the newer ones for high-altitude work look like bombs. Synchronization is obtained automatically by a photoelectric device which opens the camera shutter when the light output of the bomb reaches a predetermined intensity so that proper exposure of about 0.01 sec. duration is obtained. Photoflash bombs usually have trail plates which partly control the bomb trajectory so that the position of the bomb at time of functioning bears the correct relation to the position of the plane with its camera and the area to be photographed. An altitude of about 8000 ft. is considered optimum for the M46 bomb.

The development of aerial cameras is usually based on the limitations of the design of photoflash bombs and on the primary consideration that maximum candlepower of the bomb is desired consistent with weight, safety, and ease of manufacture. The standard photoflash powder consists of 55.5% barium nitrate and 44.5% of a powdered magnesium-aluminum alloy, the metals being in equal proportions. The powder ignites quickly with a sharp report more like a detonation than a burning.

Photoflash Bomb M23A1. This bomb, Fig. 182, is a cylinder 25.4 in. long and 4.25 in. in diameter; it weighs 10.6 lb., contains 7.75 lb. of photoflash powder, emits a peak candlepower of 150 million with a duration of flash of 0.20 sec., and is best released from 4000- to 7000-ft. altitude because it is fitted with a fixed delay of 15 sec. When it is released, the hang wire which is attached to the arming wire retainer pulls the friction wires through the match-head composition of the fuze and it also pulls the hang-wire container away from the bomb so that both fall freely. The delay element burns for 15 sec. and then ignites the flashlight powder.

This bomb provides a high-intensity light for a short duration for night photography, but it cannot be dropped from more than 7000-ft. altitude because of the fixed delay. It has been replaced by the variable time type photoflash bomb.

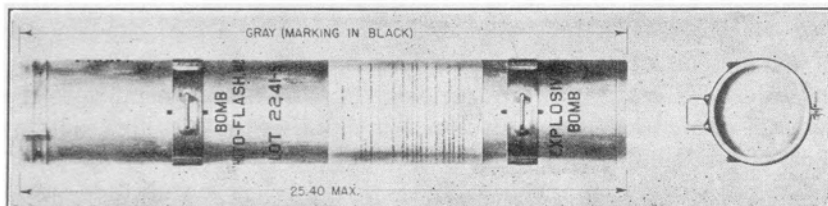

FIG. 182. M23A1 photoflash bomb.

Photoflash Bomb M46. This is the standard photoflash bomb of the general size and shape of a 100-lb. GP bomb fitted with the M111 type fuze so that it can be dropped from any altitude to function at any lower altitude by properly setting the time fuze. It is 48.4 in. long and 8 in. in diameter, weighs 51.9 lb., contains 25 lb. of photoflash powder, emits a peak candlepower of 800 million with 500 million average candlepower over 0.20 sec., and is best dropped from 7500- to 25,000-ft. altitude by properly setting the 5- to 93-sec. fuze. The powder is loaded into a standard fiber container slipped into the comparatively thin steel case of the bomb. Ignition of the black-powder booster of the fuze ignites black powder in a cup directly under the booster, driving the cup and its burning contents into the photoflash composition for

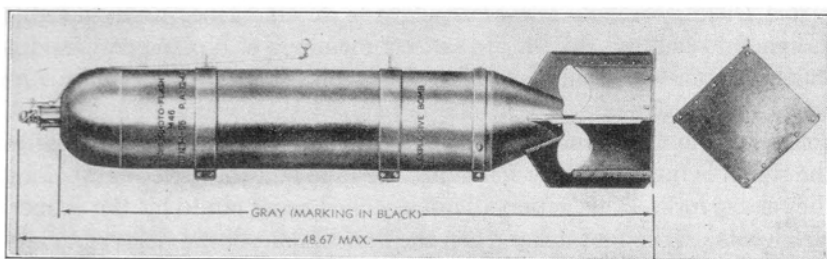

FIG. 183. M46 photoflash bomb.

certainty of ignition. When the bomb is released, the arming wire is withdrawn, thus arming the fuze and starting the time mechanism. At the expiration of the predetermined time, the black-powder booster of the fuze ignites the bomb with a sharp report like a detonation. The M46 photoflash bomb is shown in Fig. 183.

Photoflash Bomb (Small). To satisfy the demand for a smaller photoflash bomb that could be released from the British flare chute in the plane or suspended in the bomb racks of American planes, a small 22-lb. photoflash bomb was developed. It contains 10 lb. of flashlight powder, is 35 in. long and $4\frac{1}{2}$ in. in diameter, and is fitted with the M111 type fuze which functions the bomb like the M46 bomb. A peak candlepower of 350 million is produced, and the flash has a duration of 0.10 sec.

Photoflash Cartridges. This cartridge is similar in appearance to the series of colored smoke aircraft signals except that the cartridge contains 3 oz. of photoflash powder and is fuzed with a 0.3-, 1-, 2-, 3-, or 4-sec. delay. It is fired from the pistol and is used for very low-altitude reconnaissance photography.

MISCELLANEOUS PYROTECHNICS

13. Distress Signals.

Distress Smoke Hand Signal Mark 1 Mod 0. This is a small, very useful, easily operated distress signal about $3\frac{7}{8}$ in. long and $1\frac{5}{8}$ in. in diameter; it weighs 0.37 lb. and consists of a metal cylindrical body filled with high-visibility, orange pyrotechnic smoke mixture which can be held in the bare hand during burning. It is functioned by tearing off the sealing tape around the end and removing the paper cap, breaking the seal by using the pull ring as a lever, holding the signal away from the face, and pulling quickly on the pull ring which will ignite the mixture as it comes out of the can. By holding the signal at approximately 30° at arms' length, no drippings will fall on the hand as it burns.

Red Distress Signal, Two-Star. This is an emergency distress signal designed to be fired from a life raft by members of a plane crew and is therefore sometimes called an aircraft signal. It is a cylinder 5 in. long and $1\frac{1}{8}$ in. in diameter. It contains two red stars which function with delays of 2 to 4 sec. and 3 to 5 sec. at an altitude of 100 to 200 ft. after the signal is functioned by removing the tape and top cover and pulling the release fork. This action allows a cocked firing pin to hit the primer, which sets off the first delay, then the first signal, second delay, and second signal, both burning for 6 to 8 sec. The signal is fired only when some rescuing aircraft or ship is near enough to be attracted by it.

Red Distress Signal, One-Star, M73. An aluminum case about $2\frac{1}{4}$ in. long and 1 in. in diameter contains this signal and allows it to be fired from M10 pyrotechnic discharger. A cork plug in the front end of the signal is blown out when an altitude of about 200 ft. is reached. Of course, the signal cannot be fired from a life raft as a discharger is required to hit the primer.

14. Marine Marker.

This is a floating marker emitting smoke for $2\frac{1}{2}$ to 5 hr. in order to mark a spot on the water for a long time. It is cylindrical, 29 in. long and $5\frac{3}{4}$ in. in diameter. It has a metal cap at one end enclosing a plastic disc. A central tube containing potassium bisulfate and sodium nitrite is surrounded by coarse magnesium-aluminum phosphide and excelsior, and at the bottom outside the central tube are two cloth bags, one of magnesium-aluminum phosphide and one of calcium phosphide. There are two orifices or water ports just underneath these bags.

When the marker is launched, the plastic cover breaks and water enters the orifices, reacting with the materials in the bags and cylinder to generate phosphine. At the same time water enters an orifice at the bottom of the central tube causing a reaction yielding oxides of nitrogen. The gases unite at the outlet pipe, and the phosphine is spontaneously ignited, yielding the signal smoke. The reaction takes place slowly. The fact that the volume of gases is many times the solid ingredients accounts for the long burning time.

15. Insecticide Mortar.

A requirement for an inexpensive, expendable mortar that could be functioned from the ground in order to disseminate insecticides such as DDT over a wide area resulted in the development of the 4-lb. insecticide mortar. It consists of a sheet-metal can with press-fit top attached to a steel stake for ground use and filled with a paper sack containing $3\frac{1}{2}$ lb. of a mixture of 10% DDT and 90% talc. The mortar is functioned by either a friction pull wire igniter or electrically by means of a squib, either of which ignites the 3 oz. of black-powder base propellant charge. After a delay of 15 sec., the mortar is projected about 80 ft. in the air, scattering the insecticide over an area of several acres in order quickly and efficiently to destroy insects, mosquitoes, lice, and many other forms of objectionable living organisms and make the area suitable for troop occupancy.

16. Pathfinder Pyrotechnics.

"Pathfinder" planes which drop pyrotechnics to mark targets for night bombing not only so that bombers may be certain of their target but also so that the target may be well defined and easy to sight are a new development involving many technical applications of illumination, radar, radio, and navigation. The subject will not be discussed in this treatise, both because of its involved nature and because of security. Suffice it to say that pathfinder pyrotechnics may be ground markers, such as thin-case bombs with delayed opening and containing many

candles which burn on the ground; seamarkers, which mark a target on the water with a substance like sodium phosphate, burning for 8 or 10 min., and skymarkers, consisting of a tremendous variety of suspended devices that provide a temporary air target.

Night pathfinder pyrotechnics are primarily a British development, as the U. S. Army Air Force engages in night bombing to a lesser extent.

TABLE 29
CHARACTERISTICS OF VARIOUS GROUND AND AIRCRAFT SIGNALS

Designation		Type	Color	Candle-power	Burning Time min.	Delay Time sec.	Rate of Fall ft./sec.	Illuminant Weight oz.	Complete Weight oz.	Length in.	Diameter in.	Propellant Charge Weight grams	Approximate Altitude ft.	Use
Number	Name													
M27	High-burst ranging signal	G	Smoke	None	5	None	2.2	6.8	3.8	1.6	32	550	Training artillery in ranging
AN-Mk 4	Night drift signal	A	Flame and smoke	3	10	Free	5.3	32	13.6	2.9	None	Over 500	Determine plane drift
AN-Mk 1	Day drift signal	A	Flame and smoke	16	9	Free	15.8	65	19	3.0	None	Over 100	Determine plane drift
	2-star red distress signal	A	Red	8,000 min. each star	6-8 sec.	2-4 (1st star) 3-5 (2nd star)	None	0.32 each star	5.5	5	1.3	4 each	100-200	Life raft distress signal
M73	1-star red distress signal	A	Red	20,000 min.	6.5 sec.	None	None	0.68	1.5	2.3	1.0	2.8	200	Life raft distress signal
AN-M59	Slick marker	A	Fluorescent slick	None	None	None	Free	900 grams	2.9	10.9	3.4	None	Any	Mark spot on water
M74	Flash and sound signal	G	Flash and noise	None	None	2-3	None	1.25	5.2	3	1.5	32.5 grains	200	Training troops
AN Mk 1	Slick marker	A	Bronze slick	None	None	None	Free		2.5	10	3.5			Mark spot on water
AN-Mk 5 Mod 1	Night drift signal	A	Flame and smoke	16.	9	Free	64	19	3.0	None	Over 500	Determine plane drift

TABLE 30
CHARACTERISTICS OF AIRCRAFT ILLUMINANTS

Designation		Minimum Candlepower	Mini- mum Burning Time sec.	Delay Time sec.	Minimum Color Value	Length in.	Diam- eter in.	Total Weight lb.	Illumi- nant Weight lb.	Rate of Fall ft./sec.	Use
Number	Name										
AN-M26	Bombardment flare	800,000	3-3.5	5-90	0.030 (yellow)	50	8	52.5	14	12	Night illumination of bombing area
M24	Bombardment flare	800,000	3-3.5	None	0.030 (yellow)	37	8	47	14	12	Night illumination of bombing area
M50	Tow target flare	60,000	6	None	0.038	22.9	2.5	7.1	5.5	None	Target for day or night antiaircraft artillery practice
	Colored towed flares	225,000 (red) 20,000 (amber) 90,000 (green)	5.5-6.5	None	0.41 (red) 0.047 (amber) 0.38 (green)	23.3	4.5	21	15	None	Beacon for rallying around lead plane in mass aircraft formations

M8A1	Landing flare	350,000	3	None	0.030	25.5	4.3	18	10	8	Emergency night landing light
M9A1	Reconnaissance flare	60,000	1	2.5	15	2	2.1	1.7	7	Illumination for night reconnaissance
M23A1	Photoflash bomb	150 million (peak)	0.20	15	None	25.4	4.3	10.6	7.8	Free	Aerial photography
AN-M46	Photoflash bomb	800 million (peak)	0.20	5-90	None	48.4	8	51.9	25	Free	Aerial photography
	Photoflash bomb	350 million (peak)	0.10	5-90	None	35	4.5	22	10	Free	Aerial photography
	Photoflash cartridge	0.10	2-3	None	7.7	1.5	1	5.8 oz.	..	Low-altitude reconnaissance photography

PART VI
ROCKET AMMUNITION

CHAPTER 11

ROCKETS

1. Introduction.

A **ROCKET** consists essentially of a container, usually cylindrical, in which gases are generated at high pressure, and some type of vent or nozzle through which the gases may escape in the form of a jet. More accurately, this combination of gas chamber and nozzle is a **ROCKET MOTOR**, to which is added some type of **HEAD** to form the practical rocket. This head may contain high explosive or other material, or be in the form of a vehicle to which the motor is attached. We speak of an artillery projectile being shot or fired from a gun, which is closed at one end, but a rocket is projected or launched from a **ROCKET LAUNCHER**, which is open at both ends, much simpler in construction and lighter than an artillery weapon of the same caliber. Rockets and their launchers form a special class of projectiles and weapons, and the rockets are collectively called **ROCKET AMMUNITION**.

Rockets have been used for a long time as fireworks and for signaling. Even before the eighteenth century some experimental work was done on rockets, and in 1805 the expedition of Sir Sydney Smith against Boulogne included some boats fitted for salvo firing of rockets. Although some development work had been done on rockets at Aberdeen Proving Ground, Maryland, as early as 1932, little interest was shown by the armed forces of this country until World War II. In 1941 the British completed the development of a successful 3-in. antiaircraft rocket, and research in this country was begun on a large scale. Both the Army and Navy, particularly the Navy, have well-established and complete rocket-development programs, and a large number of individuals, laboratories, and agencies of both the armed forces and commercial and educational institutions are now involved in rocket work. In fact, most of the principal advancements in rocket theories and their applications to practical design have taken place since 1940.

FUNDAMENTAL CONSIDERATIONS

2. Formation of the Jet.

Consider a chamber entirely closed except at one end which is narrowed down to form a throat, as shown in Fig. 184. Gas, generated in the chamber at a pressure of P_C , flows through the throat to the atmosphere, the pressure at exit being P_E , and that of the atmosphere being P_A . The **NOZZLE** is that part of the chamber from the point at which it begins to decrease in diameter to the end of the vent, or **VENTURI**, as it is usually called. The pressures at the throat and exit (throat and exit pressures coincide in Fig. 184A), are determined by the chamber pressure P_C and the thermodynamic properties of the gas. The temperature at the throat

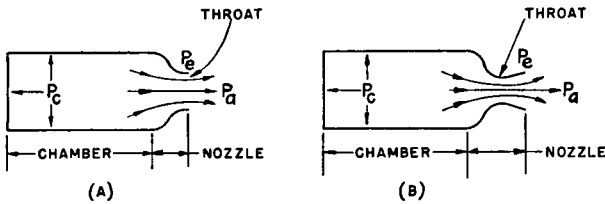

FIG. 184. Illustration of rocket motor principle: relationship between chamber, nozzle, throat, and jet.

and at exit are determined by the temperature in the chamber and the thermodynamic properties of the gas. Provided that the pressure P_C is greater than a minimum critical value, it will be found that the pressure at the throat is directly proportioned to the chamber pressure P_C , and that the temperature and velocity at the throat are independent of P_C . The existence of these conditions is called **NOZZLING**, and all military rockets are designed to operate under these conditions.

With a convergent nozzle, as in Fig. 184A, the gas is discharged at a pressure greater than atmospheric, but with a convergent-divergent nozzle, as in Fig. 184B, the gas is expanded further to increase its velocity at the expense of a further decrease in pressure. The nozzle may be designed so that the pressure at exit P_E is even less than P_A , a condition described as "overexpansion," and undesirable, as we shall now see.

3. Thrust.

The fundamental equation for the thrust of a rocket is given by $F = (P_E - P_A)A_E + k\dot{m}V_E$, where F is the thrust on a rocket motor, P_E and P_A have been defined, A_E is the area of the exit (not throat in the case of a convergent-divergent nozzle), \dot{m} is mass rate of discharge, V_E is velocity at exit, and k is a factor correcting for the divergence of

the nozzle at the exit. Since k is almost unity up to fairly large angles of divergence, the equation we will discuss is:

$$F = (P_E - P_A)A_E + \dot{m}V_E \quad (49)$$

For a motor operating at a given chamber pressure, F is maximum when $P_A = 0$; that is, the external pressure diminishes the thrust. Therefore the motor does not move forward by pushing back the surrounding air, but would, in fact, move faster in a vacuum. Now, the quantity $P_E A_E$ decreases as we slowly increase the exit area A_E , because P_E decreases more rapidly than A_E increases. Also, the quantity $P_A A_E$ increases, since P_A is constant. Therefore $(P_E - P_A)A_E$ decreases rapidly. Now, up to the point where $P_E = P_A$, V_E increases at a rate to more than compensate for the loss in $(P_E - P_A)A_E$, so that the thrust F increases, but further increase in A_E makes $(P_E - P_A)A_E$ negative. Therefore, the maximum value of F occurs when $P_E = P_A$. If $P_E < P_A$, overexpansion has taken place, and the rocket is held back by "suction," since F is less than its maximum. The following conclusions can now be drawn:

- (a) External pressure diminishes the thrust.
- (b) The rocket motor operates most efficiently in a vacuum, being projected by the unbalanced system of forces in the motor, not by "pushing back the surrounding air."
- (c) Maximum thrust occurs when $P_A = 0$, and when gases are expanded to $P_E = P_A = 0$. This would require a very long, gradually diverging nozzle, usually not practical, and expansion to the condition of operation in a vacuum. In practice, expansion to $P_E = P_A$ indicates efficient motor operation.

4. Propellant Powder.

The general requirements of rocket powder are that the grains be much larger than those of artillery powders, for ease of mounting in the motor tubes and on trap assemblies, Fig. 185, and that the powder be somewhat slower in burning. It is preferable to manufacture such large grains without a solvent so that long drying times for such large grains will not be necessary, and warpage and other undesirable features will be avoided. Some alternative-type rocket powders are made without solvents and do not require long drying times, like the Navy powder, for example. The powder now used by the Army, however, is made from nitrocellulose and a solvent, because such powder is readily available in large quantities with present manufacturing equipment.

A double-base powder is used to take advantage of high energy content, the usual powder consisting of about 59% nitrocellulose, 40%

nitroglycerin, and small amounts of ethyl centralite and diphenylamine. The 2.36-in. or bazooka rocket takes five sticks of powder, of $\frac{3}{8}$ -in. diameter, each grain being 4.15 in. long, with a single perforation of 0.08-in. diameter. The 3.25-in. target rocket and the 4.5-in. rockets take stick powder of $\frac{7}{8}$ -in. diameter, each grain being $5\frac{1}{8}$ in. long with a single perforation of 0.281-in. diameter, suitable for assembling on the wires of the trap mechanism. The energy content of these powders is about 1300 cal./gram, as compared to about 800 for the usual cannon

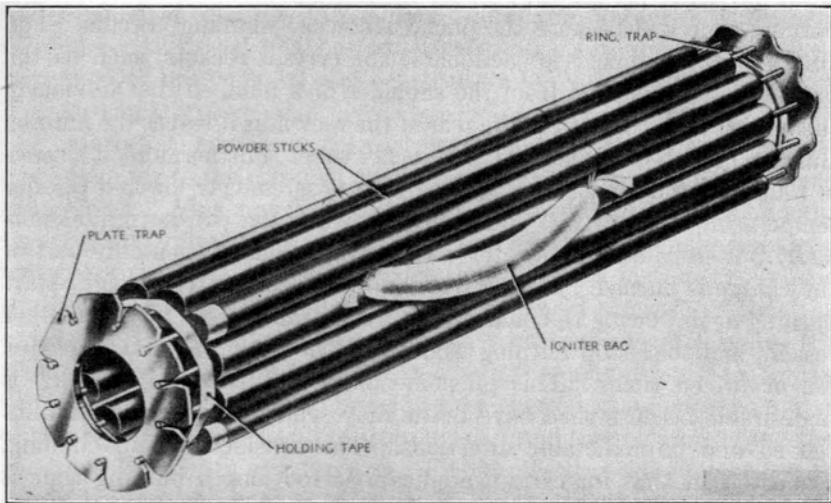

FIG. 185. 4.5-in. trap assembly.

powder. Powders of the so-called composite type, such as one containing equal amounts of ammonium picrate and sodium nitrate, with a plasticizer added, are sometimes used because they are more easily manufactured, easily formed into unusual shapes, and easily loaded. Although they usually are not subject to "chuffing," or non-uniform burning, they do burn with a pronounced smoke. It is expected that powders of the composite type will find considerable application in American rockets.

Contrasted to the artillery projectile which is fired from a closed-end weapon and reaches maximum velocity at the muzzle, the rocket carries its propellant powder along with it, and its maximum velocity may not be at the muzzle of the launcher tube or at the time of leaving the launcher rail, but some time later.

The pressure in a rocket is a balance between the burning of the powder tending to increase the pressure and the escape of gases through the

nozzle tending to reduce the pressure. In rocket design it is usual to select a certain charge which when fired at normal temperatures gives a pressure considerably under the bursting pressure of the rocket. Then at higher temperatures the pressure will be higher, and there will be a temperature beyond which the rocket cannot be used safely without decreasing the propellant powder charge. These considerations establish an upper operating temperature limit.

The lower temperature limit is established, not because of the existence of low pressures per se, but because too low a pressure means too long a burning time and because the phenomenon of "chuffing" occurs. Too long a burning time is objectionable for certain rockets, such as the bazooka, which is fired from the shoulder of a man, so that obviously there must be no flash from the rear of the rocket as it leaves the muzzle. Burning must be complete in the launcher tube. Furthermore, if a series of rounds of the same rocket is fired with progressively lowered powder temperature, a point will be reached at which the powder ignites normally but stops burning abruptly and spontaneously when only part of the charge is burned. Then a fraction of a second later it might start burning again, owing to contact with a hot trap wire or for some other reason, and then stop burning again, and the cycle might be repeated ten or fifteen times. This phenomenon, which is called chuffing, is undesirable because successive blasts may send the rocket off in unintended and unpredictable directions. The consideration of chuffing, plus the fact that for certain applications too long a burning time is objectionable, determine the lower operating temperature limit.

It is unfortunate that rockets must be restricted in the range of temperature over which they may be operated. The standard M8A3 4.5-in. rocket may be operated between -10° and 105° F. only. Since we never know in global warfare whether we will be fighting in Iceland or the South Pacific, special provision must be made for adjusting rocket propellant powder charges for firing outside the established temperature ranges. Much work is being done in an effort to improve this situation.

5. Efficiency.

Both rockets and artillery projectiles utilize the gases obtained by burning a solid propellant to move a pay load. Efficiency of a rocket may be defined in several ways, but it is customary to consider it the ratio of the actual kinetic energy imparted to the projectile to the total energy available from the propellant. Another method of determining efficiency is to consider the overall thermodynamic efficiency of the rocket as a heat engine. Owing to heat loss, incomplete combustion, divergence at exit, frictional drag of gases on walls, etc., the efficiency

of a rocket is of the order of 50% or less. This subject is completely discussed in the literature.

6. Stability and Accuracy.

The motion of a rocket outside the launcher tube or after it leaves the launcher rail is divided into two parts: motion from launching until the powder is completely burned, and motion after the powder is completely burned. Rocket motion after the propellant powder is completely burned is like motion of an artillery projectile, subject to the same laws and method of analysis, but motion before the powder is completely burned needs special analysis and treatment. The analyses for these two motions are complex and constitute a special study in itself, not discussed in this treatise.

Since rocket launchers themselves impart no rotation to rockets corresponding to the rifling of a gun, stability must be obtained by some other means. Fins may be attached to obtain stability, as on smooth-bore mortar projectiles; such rockets are called **FIN-STABILIZED ROCKETS**. On the other hand, a ring of nozzles may be used instead of a single central nozzle, each separate nozzle being canted sidewise so that the passage of the propellant gases through them imparts rotation to the rocket; such rockets are called **SPIN-STABILIZED ROCKETS**. The torque producing rotation is caused by jets whose lines of action miss the center of gravity so that the resultant torque is around the rocket axis and the resultant thrust is along the axis. Fin-stabilized rockets might rotate slowly because of some irregularities of the fin construction, but no induced rotation is intended. Spin-stabilized are more accurate than fin-stabilized rockets because malalignment of the jet is relatively unimportant since the rapid spin tends to average out its effects, and because the drag of the fins is absent. For example, from a 10-ft. launching tube, the finned 4.5-in. M8-type rocket has a dispersion about $1\frac{1}{2}$ times that of the spinner-type rocket. At the present time the trend in 4.5-in. rockets is towards the M16-spin-stabilized type, whereas the 2.36-in. rocket and those over 4.5 in. are fin-stabilized. It must be remembered, however, when firing from aircraft, that the increased linear velocity without a corresponding increase in angular velocity may reduce stability.

The accuracy of rockets is obviously greatly increased by firing them from aircraft in the same direction as the plane's flight, because the rocket has a velocity with respect to the air at the moment of firing equal to that of the plane itself. Therefore the rocket behaves as if it were fired from a very long launcher from the ground, under which conditions its direction would be controlled for a much longer time than usual, and

until the rocket had attained a higher velocity than usual. A rocket launched from a so-called zero-length launcher on a plane traveling 400 ft./sec. has an air speed of 400 ft./sec. at the instant of release, and this speed would require an equivalent ground launcher some 50 ft. long. A dispersion of 20 mils in ground firing might be reduced to 4 to 8 mils in aircraft firing.

Additional information on accuracy, range, and dispersion will be given in the discussions of individual rockets.

7. Classifications of Rockets.

Since rockets differ from artillery ammunition in the method of propulsion and in the type of propelling equipment, but not in the mission to be performed at the target, we expect rockets to be classified in about the same way as other ammunition. The general classifications of rockets are as follows:

According to Service Use.

SERVICE ROCKETS, which perform a mission at the target, because they are fired against the enemy.

PRACTICE ROCKETS, for training troops in the operation of rockets and rocket launchers and in marksmanship.

According to Tactical Use.

HIGH-EXPLOSIVE ROCKETS, which have high-explosive heads in front of the motor tube, and which are used for demolition or fragmentation.

ARMOR-PIERCING ROCKETS, which have a heavy armor-piercing nose and body, and a smaller amount of high explosive, or are of the HEAT type. A **SEMI-ARMOR-PIERCING ROCKET** is similar to an SAP bomb, being a compromise between an HE and AP rocket.

CHEMICAL ROCKETS, which have the head loaded with chemicals, smoke mixtures, or incendiaries.

According to Method of Stabilization.

FIN-STABILIZED ROCKETS, equipped with either fixed or folding fins for stabilizing the rocket similar to smooth-bore mortar projectiles, bombs, rifle grenades, etc.

SPIN-STABILIZED ROCKETS, equipped with several nozzles so designed as to create a torque about the rocket axis, causing it to spin.

In addition, rockets are designed for special applications, such as the 3.25-in. target rocket for training of antiaircraft artillery batteries.

ROCKET COMPONENTS

8. General.

As in artillery shell and fuze design, rocket metal parts such as the motor casing, powder trap, fuze and head, must be designed to have

sufficient strength to withstand the loads imposed. But since a rocket is always operating under a handicap in that the motor is not all pay load, it is essential that all metal parts be kept as light as possible. This imposes stringent demands on the designer because he may not employ large factors of safety, as is customary in artillery projectile design. The principle of empirical design is the same, however, because new rockets usually have characteristics similar to existing ones, and, in any event, complete and thorough testing is essential as well as theoretical calculations of stresses.

Many rockets contain a SAFETY GROOVE near the front of the motor where it is attached to the head. This groove is designed purposely to weaken the rocket at that point because of the low factor of safety used in the design, so that if the chamber pressure happens to rise above the normal operating value the rocket will break clearly at the groove and not cause excessive damage. The head will be projected a short distance down range, the motor or chamber expelled backwards, and the trap probably expelled forward slightly after the head and burster tube.

The problems of rocket design are like those of artillery-projectile design in that the design is strictly a compromise. We cannot have maximum pay load, maximum velocity, maximum range, and minimum dispersion all at the same time. If we put in too much powder in order to obtain high velocity, the rocket may blow up when fired on a warm day. If we design so as to obtain this high velocity at a low pressure, we find that we cannot hit the target, because attainment of high velocity at low pressure requires excessive burning distance and attendant irregularities. If we attempt to have too high an explosive pay load, we end with short range and poor accuracy. Safety is always a consideration, and safety means comparatively low pressure, which usually results in inaccuracy. Finally, in global warfare we never know whether we will be fighting in the arctic or the tropics, and rockets in their present stage of development are extremely susceptible to change in temperature.

9. Description of Typical HE Rocket.

In order to understand the construction of a typical rocket, the 4.5-in. M8 rocket is shown in Fig. 186 with the principal parts clearly indicated. The three essential parts of the rocket are the steel HEAD containing the high-explosive bursting charge; steel MOTOR, containing the propellant and IGNITER, and having the tail end in the form of a NOZZLE with some method of stabilization. The front end of the head is threaded to take the FUZE, similar to an artillery shell, with a cavity for the booster formed in the high explosive. The motor is threaded to the head and

contains a TRAP ASSEMBLY consisting of steel wires parallel to the rocket axis on which the single perforated long powder grains are strung. An IGNITER BAG of black powder is placed near the propellant about in the middle of the motor, and the main igniter is in the throat of the nozzle, composed of a plastic body filled with black powder and a squib assembly. The head is elongated in the form of a burster to take up the central space in the center of the trap assembly so that the high-explosive pay load is increased and some fragmentation of the motor tube is obtained, in addition to that of the actual head.

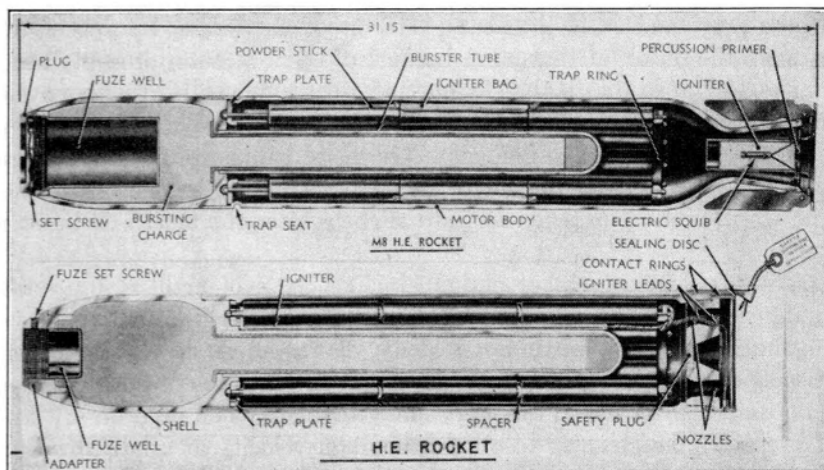

FIG. 186. Typical fin- and spin-stabilized rockets.

Figure 186 also shows the essential parts of the 4.5-in. rocket of the spin-stabilized type. The head is the same as that of the M8 rocket, except that the fuze well is smaller to accommodate a standard artillery fuze, the use of which is possible because rotation is available for arming. The motor tube contains a trap assembly similar to that of the M8, but the igniter runs the length of the trap assembly so that the igniter bags are unnecessary. The igniter wires are fastened to two contact rings around the eight nozzles. Both the M8 and M16 are described in Art. 16.

10. Rocket Fuzes.

General. Rocket fuzes are similar to artillery fuzes, and the same principles of design are applied. A rocket is a projectile, and the action of the projectile at the target is controlled by the fuze. Furthermore, the types of action desired at the target are the same: superquick action

for surface burst, delay action for penetration, proper initiation for HEAT rockets, etc. Rocket fuzes are classified the same as artillery fuzes, except that at the present time the time fuze has not been used on rockets.

One point of difference between rocket and artillery fuzes is in the arming requirements, owing to the lower accelerations, rotations, and velocities of rockets. The methods of arming are sometimes the same, but the forces may be so small that other methods such as arming vanes which rotate in the air stream may also be applicable. The most unfavorable arming conditions exist when the rocket is operated at low temperatures, because the propellant powder burns slowly and the acceleration, rotation, and velocity are minimum. It is desirable to know the pressure-time curve of the rocket propellant and the minimum velocity of operation at the minimum rocket temperature. If rotation is to be used in arming, the lowest speed of rotation must be known or calculated. If setback force is utilized in arming, the minimum force must be known or calculated. If the rocket must be safe for a given distance in flight, this requirement must be known. Also the minimum range at which the round is expected to function may be an important arming consideration for very short-range rockets.

Whereas artillery projectiles are subject to setback forces as high as 5 to 10 lb./grain, the maximum setback force of a rocket may be as low as 0.007 lb./grain. It is not usually considered good design to employ these low setback forces alone for arming, and, therefore, some fuzes require both rotation and setback for arming, or rotation alone. Others must meet the requirement that arming shall not be completed until the end of burning of the propellant. To meet this requirement a definite time delay, usually mechanical rather than a powder train, is built into the fuze to provide a definite arming time independent of variation in arming forces.

Of course a rocket fuze must fulfill all other requirements of a good fuze, such as satisfactorily passing jolt and jumble, transportation, and handling tests, and storage under adverse conditions.

2.36-in. Rocket Fuzes (M400). Since the 2.36-in. M6 series of rockets (bazooka) are of the HEAT type, having low setback, no rotation, and small diameter, a small impact-type base-detonating fuze is used. It is similar to the fuze in the M9A1 HEAT rifle grenade and has a safety pull pin which passes through the inertia firing-pin plunger and is withdrawn just before loading in the launcher. On setback, the plunger is held away from the primer, and after acceleration the tendency of the plunger to move forward is resisted by a creep spring ahead of the plunger. Upon impact with a resistant target, the firing-pin plunger

moves forward to overcome the resistance of the creep spring and fires the detonator.

An improved fuze for the bazooka, known as the M400 and shown in Fig. 187, incorporates the additional safety feature of a bore-riding pin. Even after the safety pin is withdrawn, the fuze cannot arm in the bore because the spring-loaded bore-riding pin cannot become disengaged

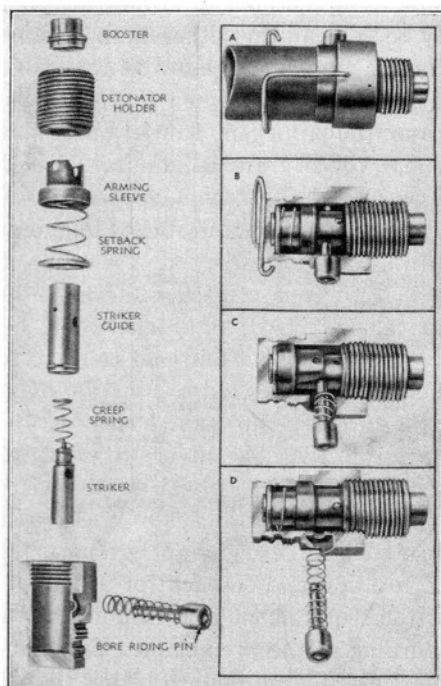

FIG. 187. 2.36-in. rocket fuze.

from the firing pin until it clears the bore. The arming sleeve, after removal of the safety pin, compresses the setback spring (B) as it moves back on setback (C), allowing the bore-riding pin to ride the bore before it is ejected (D).

Point fuzes for 2.36-in. HEAT rockets may be either of the arming-vane type, or may be similar to the M52 mortar fuze, employing the bore-rider principle. A shaped-charge auxiliary detonator may transmit the impulse down a central passage to the booster to obtain rear initiation of the shaped charge.

4.5-in. Rocket Fuzes (M4A2, M81). The 4.5-in. rocket is a high-explosive rocket for general demolition work; it requires a combination superquick and delay fuze, similar in actions to the M48 artillery fuze.

The M8 series of fin-stabilized rockets requires a fuze arming on very low setback, and one not requiring rotation for arming, whereas the

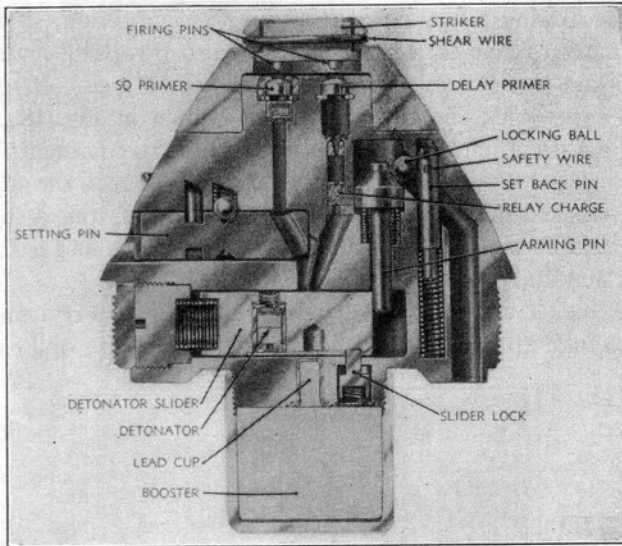

FIG. 188. Fin-stabilized superquick and delay rocket fuze

M16 series of spin-stabilized rockets may have a fuze similar to the M48 because the rotational forces are adequate for arming.

Fuzes for fin-stabilized rockets. The M4 combination superquick and short-delay fuze is used on the M8 series of rockets since it requires only setback for arming. It is shown in Fig. 188 in cross section and in Fig. 189 in external view. It consists of a heavy brass or bronze body containing a setting pin, slider, and two explosive trains (delay and superquick) and it has a firing pin, head, and a booster attached. Upon setback, the setback pin (safety pin withdrawn) moves back when sufficient acceleration has been obtained, usually outside the launcher because of the rate of powder burn-

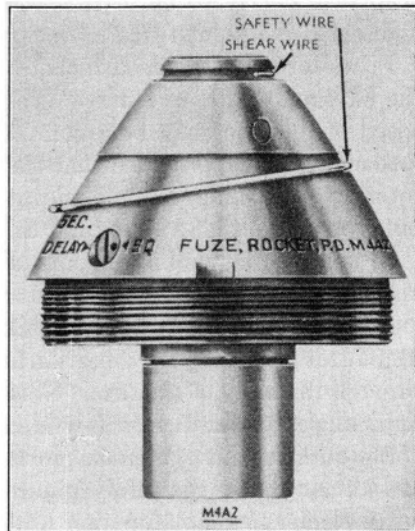

FIG. 189. Fin-stabilized rocket fuze.

ing. The locking ball runs down a passage, releasing the arming pin. The arming pin remains in the rearward position during setback, restraining the slides and providing safety during this period. After setback, the arming pin moves forward by spring action, so that the slider can move over to the armed position, also by spring action. The slider is locked in the armed position by the slider lock. If set superquick, the superquick channel is open, as shown in Fig. 188, so that on impact the superquick primer fires through to the detonator, booster lead, and booster. If set delay (usually 0.015 or 0.10 sec.) the superquick channel is blocked off so that the delay primer fires the delay, relay, detonator, and booster. This is not a very simple fuze and is somewhat difficult to manufacture.

The M4 rocket fuze has an auxiliary booster of tetryl and TNT, Fig. 190, to take up the balance of the space in the fuze well cavity not

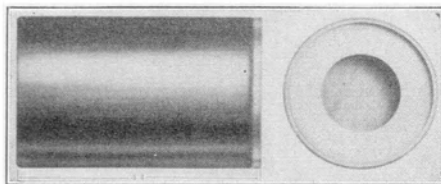

FIG. 190. Auxiliary booster for M4A2 rocket fuze.

occupied by the fuze. The deep cavity allows other fuzes requiring the deep fuze cavity to be used. The M4 fuze is also adapted to larger high-explosive point fuzed rockets.

Fuzes for spin-stabilized rockets. Spin-stabilized 4.5-in. rockets, like the M16 and M20 series, have fuzes requiring rotation for arming. The speed of rotation may be around 12,000 r.p.m. The M48A2 artillery fuze may be used, provided that the M21 or M24 booster, requiring only rotation for arming, accompanies it. The M81 rocket fuze is the combination of the M48A2 fuze and the M24 booster.

In order to allow 4.5-in. spin-stabilized rockets to be shipped fuzed, and because of the possibility that spin-stabilized rockets in ammunition dumps, if ignited prematurely, would be armed in flight if fitted with the M48 fuzes (requiring only rotation for arming), a safety pin may be added through the body of the fuze. This pin passes through the fuze body at right angles to the fuze axis and interrupts the central channel ahead of the interruptor. A guide pin is added to the inertia plunger body at right angles to the safety pin and bearing on it, so that the inertia delay element cannot function until the pin is unscrewed by means of its ring. Thus, neither the superquick nor the delay element can func-

tion if the rocket takes off accidentally with the safety pin not removed. Furthermore, the rocket can be shipped fuzed with such a fuze because of the safety provided by the additional pin.

For chemical and smoke spin-stabilized rockets, a fuze of the M57 type but having the safety feature mentioned above has been developed. It has a detonator and small booster in the bore to function the shell.

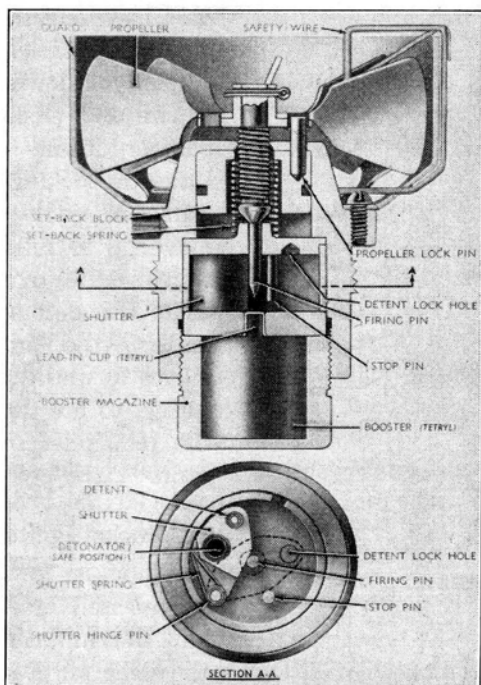

Fig. 191. Mk 137 superquick rocket fuze.

Fuzes for 7.2-in. and Larger Rocket (Mk 137, Mk 146). The Mk 137 fuze is shown in Fig. 191. It is a vane-arming, detonator-safe, superquick fuze, having a safety pull wire passing through a setback block. The shutter contains the detonator in an out-of-line position and is prevented from rotating to the armed position by the firing pin. Upon setback, the setback pin and propeller lock pin move back to allow the vane to rotate, and after about 15 revolutions the arming pin moves up an amount sufficient to allow the shutter to move to the armed position by spring action. Upon impact the firing pin is driven into the detonator, which fires the booster lead and booster. A guard around the propeller protects it and regulates the flow of air by means of its vent holes. This

uze is used on such rockets as the 7.2-in. high-explosive rocket shown in Fig. 196, which is of the fin-stabilized type without rotation.

A base fuze for such rockets as the 7.2-in. is shown in Fig. 192. This is the Mk 146 BD fuze, armed by both pressure and setback, without

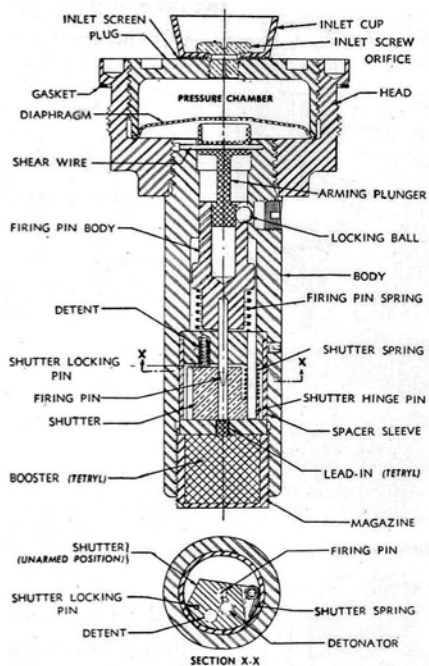

Fig. 192. Mk 146 non-delay rocket fuze.

rotation. Arming time is partly controlled by the time it takes the propellant gases to leak through the inlet screen and build up pressure sufficient to push the diaphragm down, thus shearing a wire and pushing the arming plunger down. This action releases the locking ball so that the firing-pin body and firing pin move up to release the shutter, which rotates by spring action to align the detonator. Then, on impact, the firing-pin plunger moves forward against the creep spring, to fire the detonator and the remainder of the explosive train.

11. Rocket Igniters.

A ROCKET IGNITER is a device for precisely igniting the propellant, thus initiating functioning of

the rocket. The rocket igniter serves the same purpose as the cannon primer. Both contain provisions for igniting some other explosive element which is more easily ignited than the propellant powder itself. The other explosive is usually black powder, the flame from which, playing over the surface of the propellant powder, raises it to a high temperature so that burning occurs.

Rocket igniters consist of three essential parts: a squib or primary explosive, a charge of black powder, and the body or case. The squib is usually functioned electrically, and its flame ignites the black powder which builds up a pressure sufficient to rupture the igniter case. The igniter case must be of the correct thickness to combine mechanical strength with proper rupturing properties; it is usually about 0.025 in. thick. It is generally made from plastic material not easily affected by the nitroglycerin of the powder, such as treated ethyl cellulose, although other plastic materials have been found satisfactory. The igniter

should function with a minimum delay, not over 60 milliseconds, because the delay in firing affects such practical items as holding a plane exactly on course during firing and holding the bazooka tube on the target after the trigger is pulled. Of course, a primary requirement of igniters is that they withstand long periods of storage and handling. Both moisture and bad mechanical treatment as well as deterioration due to reaction with nitroglycerin may cause them to fail.

It has been found that it is better to house the black-powder igniter charge in a moderately strong plastic container than to put it loosely into bags, as shorter ignition times are obtained. A delay of 10 to 30 milliseconds after closing the firing switch is usual, but soft-case igniters may have much longer delays. Sometimes the main igniter is supplemented by a bag igniter placed along the powder grains; by this arrangement a short ignition time is combined with dependable ignition, with no significant effect on the pressure-time characteristics.

The location of the igniter is important; it is best placed where the flow of gases from it will completely envelop the propellant powder surface. It is usually located at the head end of the motor chamber but may be put at the nozzle end of the chamber or along the propellant charge.

The 2.36-in. rocket is ignited by a squib alone. The 4.5-in. rockets have a suspended igniter, shown in Fig. 186. Many experimental igniters are under consideration, including bayonet, induction, and other types.

12. Rocket Motors.

The design of the motor will not be discussed in detail, as the usual principles of machine design and stress analysis may be applied. Alloy steel of high ultimate strength and fairly high ductility is necessary because the motor is designed with small factor of safety so as to decrease the non-pay load; also, a comparatively thin motor tube is easier to fragment. The motor safety groove is usually designed to fail at about 6000 lb./sq. in., but later designs using steel of 135,000 lb./sq. in. ultimate strength omit the safety groove. The nozzle section of the motor is commonly heavier than the body because of the flow of hot gases through that section and the attachment of the fins. The standard M8 rocket motor is 0.132 in. thick.

DESCRIPTIONS OF TYPICAL ROCKETS

13. 2.36-in. Rockets (M6, M7, M10).

High-Explosive Types. The M6A3 HEAT type was the first of all the rockets to prove itself in battle; together with its launcher it is

known as the "bazooka." The M1A1 launcher is a one-piece electrically operated weapon of the open-tube type; it is fitted with a shoulder stock to house dry batteries, and a trigger arrangement to close the circuit and fire the rocket. It has been replaced by the M9A1 launcher, made in two pieces for carrying on a man's back, and assembling to 61 in. overall length with a weight of 16 lb. It is fired with a magneto arrangement, making it independent of batteries, the magneto generating

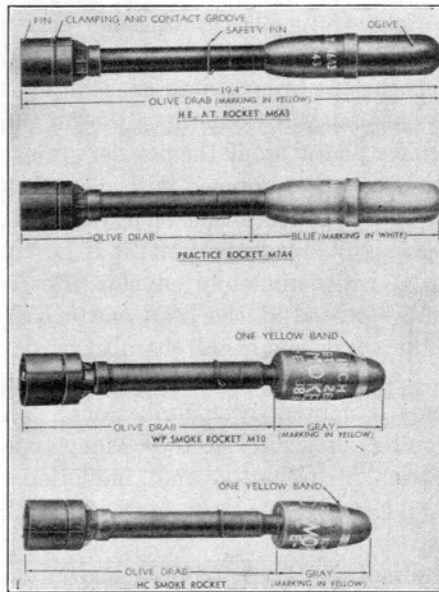

FIG. 193. 2.36-in. rockets.

a voltage when the trigger is pulled down or when it is released. The muzzle velocity is about 260 ft./sec., and the maximum range is 600 yd., but, since the rocket is a hollow-charge round necessitating a direct hit at nearly normal impact against a tank, armored vehicle, or other resistant target for proper functioning, the effective range is much less, probably not more than 200 yd. This rocket is for both defense and offense, and the bazooka does actually give the lone infantryman a chance of stopping a tank at close range. It is a weapon of opportunity and can be fired from the shoulder, standing, kneeling, or prone, and is effective against pill boxes and emplacements as well as against armor plate.

The 2.36-in. HEAT M6A3 rocket, Fig. 193, is similar to the M9A1 rifle grenade except that it contains a propelling charge which gives a tremendous flash to the rear for about 20 ft. through the open end of the launcher when it is fired. The rocket is 19.4 in. long, weighs 3.4 lb.,

and consists of a shaped-charge head containing 0.5 lb. pentolite, with false ogive, impact fuze with a safety pull pin, stabilizer tube of alloy steel containing 0.14 lb. propellant powder and simple squib igniter, and fin assembly with contact wires. One wire is attached to the fin assembly; the other is loose for attaching to the body of the launcher, the circuit being completed through the magneto (or batteries). The powder burns in about 0.08 sec. at 120° F., and combustion is complete at the muzzle. The fuze is known as the M400, and, after the safety pull wire is withdrawn just before loading, it requires only a resistant target to cause the impact plunger to ride forward into the detonator against the restraining creep spring.

This rocket is effective against armor or other obstacles and gives some fragmentation, and the heat generated by the shaped-charge jet will explode ammunition dumps or set gasoline trucks on fire.

An improved bazooka type, designed to give a velocity of about 540 ft./sec. and a range of about 1000 yd. at 15° elevation, has been developed. It has a charge of about 1 lb. pentolite and is expected to have greater penetration of armor than the standard bazooka M6A3. Operating temperature limits are also increased to -20 to +130° F. The propellant consists of 0.4 lb. of center-drilled wafers on a central rod, and the burning time is about 0.01 sec. for the entire range of operating temperatures. Stabilization is by folding fins similar to those of the 4.5-in. fin-stabilized rockets.

The round weighs 6.2 lb., almost twice that of the M6A3, is 21.8 in. long, and fuze with a point-initiated base-detonating fuze, although other types may be satisfactory.

Practice Types. The practice rocket M7A4, Fig. 193, is like the HEAT rocket except that the fuze, shaped charge, and liner are replaced by a steel bar to give the same weight, center of gravity, and ballistics as the high-explosive type.

Chemical and Smoke Types. A number of chemical-type 2.36-in. rockets have been developed, including WP and other types. The M10 WP smoke rocket weighs the same as the HEAT rocket (3.4 lb.), has the same powder charge and same type of fuze, but is 17.1 in. long. The booster is replaced by a burster, and the head is loaded with 0.9 lb. WP smoke. This round allows the bazooka to lay down a smoke screen at short ranges to cover local front-line movements; it is also somewhat effective against personnel in trenches, pill boxes, and foxholes.

14. 3.25-in. Antiaircraft Target Rocket (M2).

In order to replace the towed sleeve, the traditional target for practice by antiaircraft batteries, with a superior target moving at

approximately the speed of hostile aircraft but under surprise conditions of variable directions and angles, the 3.25-in. M2 target rocket was developed. It is launched from the M1 mobile projector, carried on a lightweight carriage fitted with two rubber tires and capable of firing at elevations from 0 to 60°. The total launcher weight is 750 lb. The range is approximately 1700 yd. at 530 ft./sec.

The target rocket shown in Fig. 194 is a thin-walled metal cylinder 34.3 in. long and 3.25 in. in diameter with an ogival head and three large equally spaced plywood fins at the tail to increase the rocket's size and resultant visibility, and its stability. These fins are assembled in the

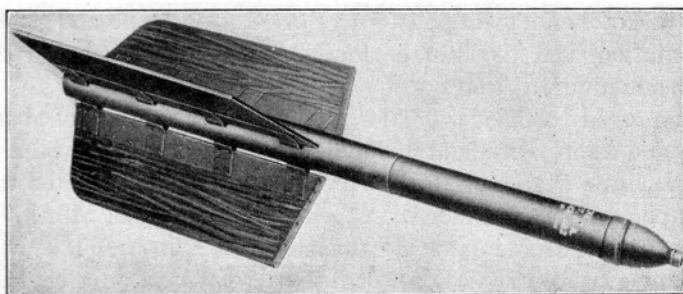

FIG. 194. 3.25-in. target rocket.

field. The rocket is 59.1 in. long and weighs 35.1 lb. The propelling charge is 3.2 lb. of $\frac{7}{8}$ -in.-diameter stick powder, composed of $5\frac{1}{8}$ -in. lengths to which shorter 2-in. or $\frac{3}{8}$ -in. lengths are added to obtain proper weight. Without the additional shorter sticks, the main charge consists of three $5\frac{1}{8}$ -in. lengths on each of six trap wires, or eighteen sticks total. The safe operating temperature limits are 30 to 120° F., and the burning time is 0.25 sec. at 30° F. The central nose cavity of the rocket contains igniting mixture, ignited by an electric squib in the front of the motor tube, and an auxiliary igniter bag is tied to the propellant powder sticks at the center of the motor tube. This target rocket has no explosive charge.

The disadvantages of such a rocket target are its small size and the fact that hits cannot be registered or recorded, but it makes a good target for such automatic weapons as the 20-mm., 37-mm., and 40-mm. antiaircraft guns and the caliber .50 machine gun.

15. 3.5- and 5-in. Rockets.

The Army has no standard 3.5- and 5-in. rockets, but these sizes are standard with the Navy. They will not be discussed in this treatise.

16. 4.5-in. Rockets (M8, M9, M16, M20, M21).

Fin.-Stabilized Rockets. The 4.5 in. series of rockets are most generally used by the Army as demolition and fragmentation projectiles and are somewhat comparable to a 105-mm. high-explosive artillery projectile. The 4.5-in. rocket is sufficiently large and contains enough explosive to cause considerable damage to both matériel and personnel, yet it is not excessive in weight and is launched from a great variety of launchers.

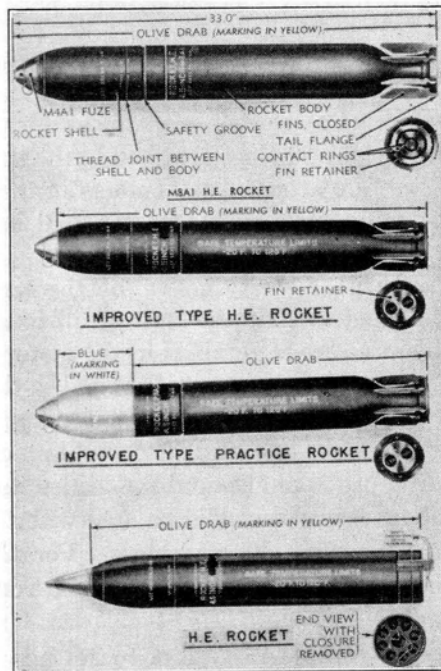

FIG. 195. 4.5-in. rockets.

It therefore exists in a variety of forms, the fin-stabilized types having been developed first and the spin-stabilized types coming later. We will first discuss the fin-stabilized types.

1. HE M8A3 and practice M9A3. This is the most common fin-stabilized rocket being used today; it is shown in Fig. 195. It weighs 38.2 lb. total and contains 4.3 lb. TNT. The rocket is 4.5 in. in diameter and 33 in. long and is fired at approximately 840 ft./sec. with a maximum range of 4000 yd. Stabilization is obtained by means of six fins which open up to a 12-in. diameter and which are attached to the rear of the venturi. The rocket is fitted with M4A2 fuze, a combination superquick and short-delay fuze, in order that some penetration of resistant targets may be obtained.

The standard low-temperature propellant powder loading formerly used for firing between 20 and 90° F. consists of thirty sticks of $\frac{7}{8}$ -in.-diameter powder $5\frac{1}{8}$ in. long mounted on the cage assembly wires. This loading was reduced to twenty-seven sticks of the same powder for firing at temperatures between 50 and 130° F. Present powder loading consists of 4.65 lb. of the $5\frac{1}{8}$ -in.-long sticks with a total of thirty sticks and with service temperature limits of -10 to $+105^\circ$ F. The burning time is 0.03 sec. at -10° F. and 0.13 sec. at 105° F. The trap assembly is shown in Fig. 185.

Ignition is by means of a plastic ethyl cellulose suspended-type cartridge igniter $14\frac{5}{8}$ in. long, $\frac{1}{4}$ in. thick, and $\frac{7}{8}$ in. wide containing 450 grains of black powder with an electric squib in the center of the powder, the ends being closed by plastic plugs attached to the trap wires for support. Squib lead wires are attached to contacts in the venturi closing cup. This type of igniter replaces the igniter used in the M8 rocket shown in Fig. 186.

The rocket is fitted with a safety groove on the carbon-steel motor body just below the head so that the rocket will break at this point if an excessively high pressure is obtained in the motor tube.

The M9A3 practice rocket is a companion round to the M8A3 rocket, having the same weight and ballistics; it is for training rocket crews in handling and firing the 4.5-in. rocket or for actual practice firing. For actual practice the M4 fuze would be fired live-loaded to give an indicating smoke puff at short ranges or would be used with the M1 auxiliary booster to give a good puff at longer ranges. For training crews in handling and loading, the M6 dummy fuze of cast iron is used with a totally inert rocket.

2. Improved types. The M8A3 type of rocket has been redesigned primarily to obtain a stronger rocket of better construction and a little higher velocity. The high-explosive type and the corresponding practice rocket are shown in Fig. 195. This rocket weighs about 40 lb., is 30.5 in. long, contains 4.3 lb. of TNT, and is propelled with 4.57 lb. of powder arranged in the same way as in the M8A3 type.

To meet the requirement for a high-capacity, high-velocity rocket for firing from aircraft, a high-explosive rocket has been developed, having range, velocity, temperature limits, motor tube, propellant powder, igniter, fin assembly, and venturi the same as for the semi-armor-piercing rocket, but the semi-armor-piercing head is replaced by a high-explosive head 20 in. long, containing 8.8 lb. of TNT, and usually fuzed with the Mk 149 fuze. The overall length is 26 in. and the total weight 98 lb.

3. Shaped-charge rockets. The 4.5-in. HEAT rocket is similar to the bazooka but much larger and has an HEAT head loaded with 4 lb. of pentolite. It is 39.8 in. long, weighs 38.3 lb., and is fuzed with the M5, or other BD fuze. It is used against armored vehicles and fortifications, and has about the same range and velocity as the M8A3 rocket. It is propelled by 4.7 lb. of powder in the form of $\frac{7}{8}$ -in.-diameter sticks, twenty being $5\frac{1}{2}$ in. long and ten being $5\frac{1}{4}$ in. long strung on a ten-wire cage. The operating limits are -20 to 120 F., and the burning time is 0.36 sec. at -20° F.

4. Armor-piercing rockets. The 4.5-in. semi-armor-piercing rocket is fired from a zero-length rail mounted under an airplane wing for use against submarines, surface ships, armored vehicles, and other targets having light armor. The maximum range is 1500 yd. from the aircraft at a velocity of 1000 ft./sec. relative to the aircraft. It consists of a 4.5-in. alloy-steel motor tube 56 in. long, containing 14.0 lb. propellant powder in the form of twenty-four sticks 10 in. long by 1.2 in. outside diameter by 0.4 in. inside diameter strung on a six-wire cage, and safe to operate between -40 and 130° F.; a semi-armor-piercing head 18 in. long containing 2.8 lb. TNT; a four-bladed fixed fin assembly about 11 in. long around the venturi; a modified M68 BD fuze; and a black-powder plastic-tube igniter. The overall length is 74 in. and the total weight 98 lb.

Spin-Stabilized Rockets.

1. HE M20. This rocket, shown in Fig. 195 as an earlier model, is of the spin-stabilized type and is similar to the M8A1 except that the propellant gases impart rotation of about 12,000 r.p.m. as they pass through the eight rear nozzles. The rocket weighs 40.5 lb., contains 5.2 lb. of TNT, is 31 in. long, and has a muzzle velocity of 830 ft./sec. with a maximum range of 5200 yd. It is fired primarily from ground launchers and fuzed with either the M81 PD fuze with M24 booster or the M48A2 fuze with the M21-type booster.

The propellant powder weighs 4.75 lb. and is arranged on a ten-wire cage similar to that for the HEAT rocket. This rocket is excellent for ground use against personnel and light armored targets and will penetrate either $\frac{3}{8}$ -in. armor or 8 in. of wood and detonate 10 to 20 ft. beyond the target. The M16 rocket is similar to the M20 in operation.

The extract from the firing tables not only gives data for this type of rocket but is illustrative of the accuracy that can be expected of rockets in general. It will be seen from these data that at the shorter range of 2100 yd. the elliptical pattern is long and narrow, whereas at 5100 yd. it is almost a circle. This is to be expected because at the higher angle of elevation the trajectory is more nearly vertical at impact. This

set of figures illustrates quite clearly a previous statement to the effect that rockets are excellent for area fire but not adapted to point fire.

2100 Yd., 10.2° Elevation, 8.4 Sec., Time of Flight

33% in ellipse	255 × 37 yd.
50% in ellipse	335 × 54 yd.
75% in ellipse	500 × 85 yd.

5100 Yd., 35° Elevation, 31.4 Sec., Time of Flight

33% in ellipse	105 × 115 yd.
50% in ellipse	135 × 140 yd.
75% in ellipse	200 × 200 yd.

2. Practice M21. This rocket is similar to the HE M20 except that it is fired with a dummy fuze or a live fuze as a spotting charge only. Weight, contour, and ballistics are the same as for the high-explosive rocket. The M17 practice rocket is similar to the M16 HE rocket.

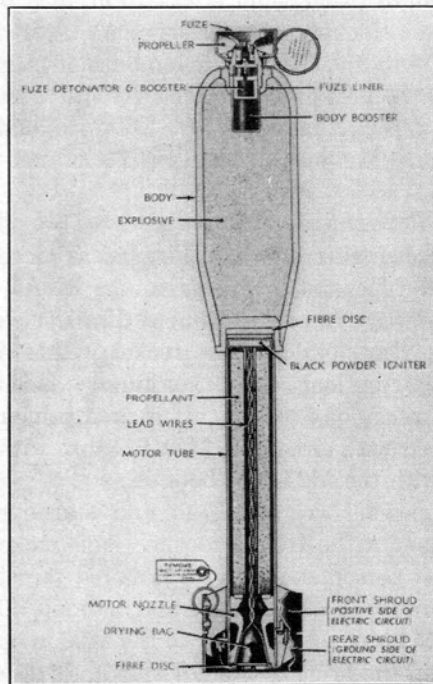

FIG. 196. Components of 7.2-in. rocket.

17. 7.2-in. and Larger Rockets.

High-Explosive Types. A high-explosive 7.2-in. rocket is shown in Figs. 196 and 197. It is a demolition rocket fired at low velocity and

short range and is fuzed with the Mk 146 BD fuze which is armed by both the pressure of the propellant and acceleration in flight. The front end of the rocket head is blunt for use against reinforced-concrete obstacles and fortifications. It weighs 61 lb. total and contains 32 lb. of TNT. It is 35 in. long and is fired at about 160 ft./sec. for an effective range of 230 yd. The propellant burns from 0.2 to 0.6 sec. or for about an average of 30 ft. of travel, and the safe operating temperature is from 10 to 120° F. The tremendous rear blast is dangerous up to 60 ft. Other 7.2-in. rockets are under development.

Chemical Types. The 7.2-in. chemical rocket is somewhat different from the high-explosive rocket in that it is fired at a higher velocity and longer range is obtained. The rocket weighs 58.1 lb., is loaded with 20 lb. of chemical, has a length of 50 in., and is fired at 680 ft./sec. for a range of 3430 yd. It is shipped without fuze or booster and fuzed with the Mk 147 Navy fuze which is propeller-

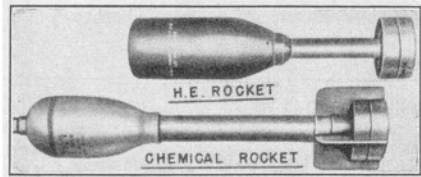

FIG. 197. 7.2-in. rockets.

armed in the field. The chemical head is attached to a $3\frac{1}{4}$ -in. motor tube containing a single propellant powder grain 2.4 in. in diameter but having three longitudinal splines and a large central perforation 0.95 in. in diameter. The igniter is of the front-end black-powder variety, functioned by wires passing through the powder central hole. It is shown in Fig. 197.

Larger rockets are possible, and there is no theoretical limit to the size of a rocket, but weight and mobility considerations limit the size and govern the construction.

ROCKET LAUNCHERS

18. General.

This treatise deals only with ammunition, reference being made to artillery weapons only to the extent that such discussion aids in understanding artillery ammunition. Rockets are ammunition, and we are interested in rocket launchers only as they affect the design, construction, and operation of rockets.

The purpose of a launcher is to aim the rocket, that is, fix the direction of flight by controlling the motion of the center of gravity until the rocket leaves the launcher. The two general types are LAUNCHER TUBES such as the bazooka and the various 4.5-in. rocket launchers, and LAUNCHER RAILS, generally used for 7.2-in. and larger rockets. Rockets launched

from aircraft have the advantage that the speed of the rocket with respect to the air is large even before launching so that "zero-length" launchers on high-speed aircraft provide fairly good stability and direction. **MULTIPLE LAUNCHERS** are groups of tubes or rails to provide

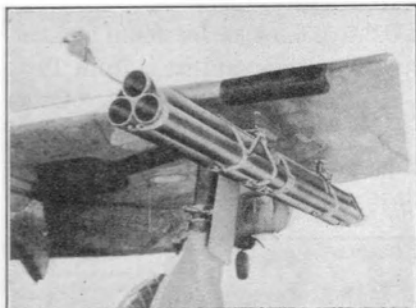

FIG. 198. Launcher mounted on aircraft.

more rapid rate of fire than can be had from **SINGLE LAUNCHERS**, where time is required for reloading. **AUTOMATIC LAUNCHERS** use the same basic unit repeatedly and employ gravity feed when fired from boats, trucks, or land.

19. Descriptions of Important Launchers.

Various types of 4.5-in. rocket launchers are in use. They are

mounted under the wings of a pursuit or attack plane in the form of a three-tube cluster, Fig. 198; on motor vehicles, in the form of a line of eight tubes which can be removed from the vehicle, set on the ground, and fired; on a tank, in the form of a battery of sixty tubes controlled as a unit from the 75-mm. gun-control mechanism and capable of being jettisoned in 10 sec. in an emergency, Fig. 199; on an LVT, truck, jeep,

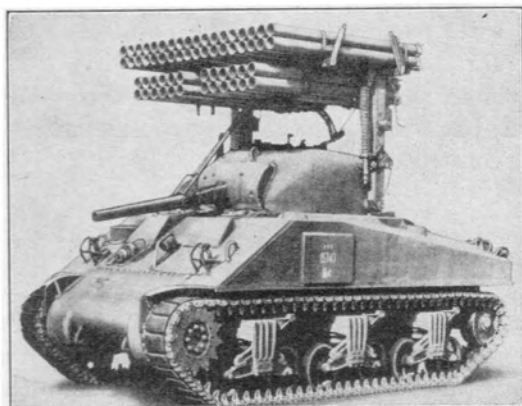

FIG. 199. Launcher mounted on tank.

peep, or any mobile unit, in the form of a gravity-feed mechanism firing twelve rockets, Fig. 200; in the form of a battery of twenty-four tubes on a light two-wheel trailer vehicle capable of being towed by a peep or a jeep and adapted to spin-stabilized rockets; and last, but not least, the 4.5-in. plastic launcher, Fig. 201, may be carried on the back of a man,

fired singly or in salvo up to ten launchers, and discarded after firing, thus providing front-line fire power equivalent to a 105-mm. artillery shell carried and fired by one man. The multiple launcher may be fired singly or in the form of ripple fire at 0.1- to 0.5-sec. intervals.

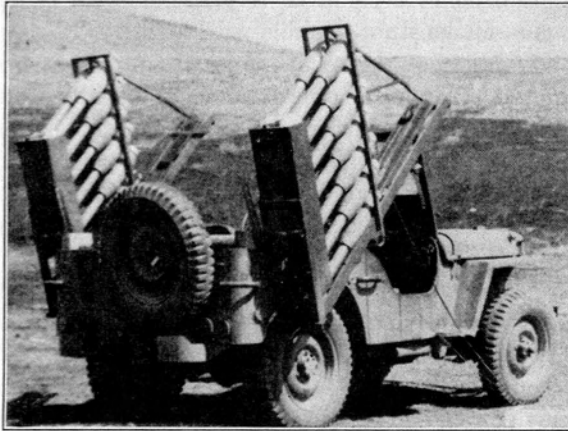

FIG. 200. Launcher mounted on $\frac{1}{4}$ -ton truck

The 7.2-in. launcher has been adapted to the $2\frac{1}{2}$ -ton truck in the form of a twenty-four-rail battery from which it is easily removed for ground firing, and to the medium tank in the form of a twenty-rail battery

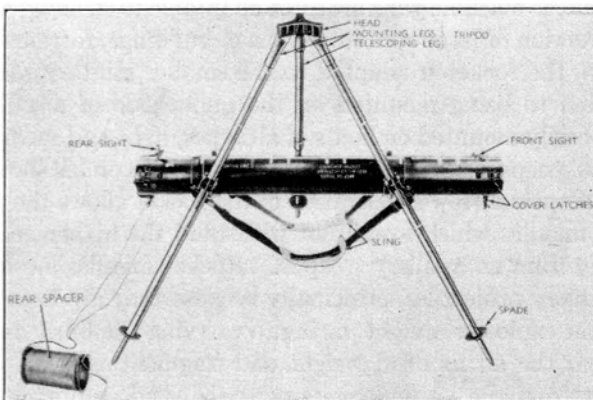

FIG. 201. Portable ground launcher.

controlled by the 75-mm. gun-control mechanism and capable of being jettisoned.

No doubt many new launchers of every conceivable type, size, and mounting will be developed in the future.

20. Advantages and Disadvantages of Rockets.

We now conclude that all rockets have distinct limitations on accuracy and temperature, and range and velocity are limited by considerations of weight and mobility. Once these are recognized, measured, and taken into account, the rocket becomes a very useful piece of ammunition, performing some missions not possible with artillery.

The chief advantage of the rocket is its complete absence of recoil, permitting the rocket launcher to be extremely light in weight compared to artillery mounts. Launchers are therefore more mobile and easier to manufacture and handle, and they can be moved to positions inaccessible to artillery of equivalent fire power. The 4.5 rocket and launcher weighs 55 lb. total, compared to 4000 lb. for the 105-mm. howitzer of about equal fire power.

Rockets do not have the accuracy of artillery, where destruction of a specific target is required, but are ideal against area targets because many launchers can be assembled rapidly at one point, fired at a high rate of fire, then either reloaded or moved forward for a second salvo. When accuracy can be sacrificed for time, that is, when ability to fire *any* ammunition is more important than the accuracy of that firing, rockets fill the bill. They put ammunition of artillery caliber in the hands of first-line invasion troops.

Rockets allow the armament of aircraft to be rounded out, as they are intermediate between the fire power of the machine gun and the bomb. Whereas machine guns are most adaptable to strafing, and bombs to the destruction of large concentrations of buildings, fortifications, and installations, the rocket is adapted to the smaller military target.

In addition to being mounted on the under side of airplane wings, rockets are easily mounted on boats of all types, light and medium tanks, trucks, jeeps, peeps, or even held by an infantryman on his shoulder.

The comparatively low acceleration of the rocket allows the projection of types of missiles which would not withstand the higher accelerations due to firing from an artillery weapon. Rocket missiles are not as efficient as artillery projectiles, principally because they are heavier than a shell of equal explosive weight, owing to carrying the burned-out motor tube through the air as dead weight and fragmenting it at the target.

The blast from the jet endangers personnel and equipment near the launcher. It is very important that there be nothing in the way of the tremendous rear blast of hot propellant gases for at least the danger distances published in the instructions for each rocket.

In general the range of a rocket is less than that of equal caliber artillery. These advantages and disadvantages are summarized in Table 31.

TABLE 31

ADVANTAGES AND DISADVANTAGES OF ROCKETS COMPARED TO ARTILLERY PROJECTILES

<i>Advantages</i>	<i>Disadvantages</i>
1. Absence of recoil.	1. Low efficiency because of dead-load motor chamber.
2. Simplicity of launcher.	2. Dangerous rear jet blast.
(a) Light weight.	3. Inaccuracy.
(b) Ease of manufacture	4. Low range for equal weight of artillery round.
(c) Ease of mounting on plane, boat, tank, truck, or can be held by man.	5. Operating temperature restrictions.
(d) Can be moved to front line or other positions inaccessible to artillery.	
3. Low acceleration.	

PART VII
MISCELLANEOUS AMMUNITION

CHAPTER 12

MISCELLANEOUS AMMUNITION

1. General.

In this chapter we shall discuss miscellaneous ammunition items, including grenades, rifle grenades, antitank mines, antipersonnel mines, booby traps, destructors, and other miscellaneous ammunition devices.

GRENADES

2. Description and Uses.

A **GRENADE** is a small missile containing high explosive or other filler for use at short ranges in trench warfare. Grenades were originally **HAND GRENADES**, thrown by hand at machine-gun nests, obstructions, or against enemy personnel at close range. In modern warfare, the grenade has become diversified; in addition to grenades for the conventional targets, **RIFLE GRENADES** are used against tanks and armored vehicles, and also for incendiary, booby-trap, demolition, smoke, and signal purposes. Progress in grenade design has included greater penetration, larger number of fragments, new fillers such as TNT, pentolite, and RDX (in place of EC blank powder), and new fuzes, which function with less noise, smoke, and sparks, thus aiding concealment of the thrower.

Hand-grenade design is limited by the maximum weight a soldier can throw to an effective range and still grasp the grenade properly for propulsion and safety. Grenades of the fixed-delay type are designed for a delay that will provide functioning at the usual range, but neither so long that the grenade could be picked up and thrown back nor so short as to be dangerous for the thrower. A time of 4 to 5 sec. satisfies this requirement, and the delay train of the usual time fuzed grenade starts to burn when the thrower lets go of the grenade, releasing the hand lever, the safety pull pin having been previously removed.

In order to increase the range of the hand grenade, a launcher is placed over the muzzle of the caliber .30 rifle or carbine, so that the

grenade may be fired from such weapons; firing increases the range to several hundred yards compared to about 35 yd. for hand throwing.

At the present time we have a complete line of fragmentation, demolition, antitank, smoke, illuminating, chemical, and practice grenades, of both the hand and rifle types.

3. Classification of Grenades.

Grenades may be classified according to their service use as follows:

FRAGMENTATION GRENADES, which contain a high-explosive charge in a metallic body, the fragments of which do most of the damage. The thrower must take cover and cannot continue advancing until a safe time after the detonation. Their effective fragment range is greater than the distance they can be thrown.

OFFENSIVE GRENADES, which contain a high-explosive charge in a paper body or other thin container and which do most of their damage by demolition and lethal shock, rather than by fragmentation. The thrower can therefore continue to advance after throwing the grenade, which accounts for the name. Their effective fragment range is safely less than the distance they can be thrown.

PRACTICE GRENADES, which contain a small black-powder spotting charge to give an indicating puff in practicing with the grenade.

TRAINING OR DUMMY GRENADES, which are totally inert, and are intended for practice throwing.

Grenades may be classified according to tactical use, or according to the particular filler, as follows:

HIGH-EXPLOSIVE GRENADES, which contain high explosive for fragmentation or blast effect, the explosive being EC blank powder, TNT, tetrytol, etc.

CHEMICAL GRENADES, containing a chemical mixture for chemical warfare. The special type of filling in common use is HC smoke mixture, such grenades being called **SMOKE GRENADES**. The smoke mixture may also be colored for signaling purposes.

INCENDIARY GRENADES, containing an incendiary mixture for starting fires.

Grenades may also be classified according to the time of functioning, as follows:

AUTOMATIC TIME GRENADES, containing a fixed delay that is set off automatically when the grenade is thrown or fired from a rifle launcher.

CONTACT GRENADES, which contain no delay but which function when the grenade hits a target at any distance within range of throwing or launching.

Hand grenades are kept safe in handling by the safety pin that holds the lever in place, thus restraining a striker under the lever. The lever is grasped by the hand used for throwing, and the safety pin is removed. When the grenade is thrown, the lever flies off, allowing the striker to rotate by spring action and strike the primer. This ignites the delay element of 4-5, sec. after which the grenade functions. Rifle grenades are also kept safe in handling by a safety pin which is removed after the grenade is placed on the launcher and before firing.

4. Grenade Fuzes (M6, M10, M200, M204, M205).

Hand Grenade Fuzes.

1. Description. There are two general types of GRENADE FUZES: the DETONATING TYPE, for functioning high-explosive grenades containing

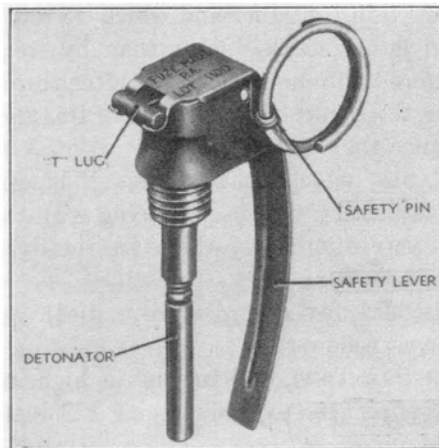

FIG. 202. Typical hand-grenade fuze.

TNT, tetrytol, or any explosive requiring explosive shock for functioning; and the IGNITING TYPE for functioning EC blank powder, black powder, or chemicals, including burning smoke. Except for the contact grenade fuze, which contains no delay and fires upon impact, all these fuzes contain a delay element to permit the thrower to take cover and to allow time for the grenade to arrive at the target. The detonating-type fuze, shown in Fig. 203, contains an upper charge of azide, and a lower charge of PETN, or tetryl, in the detonator cup below the delay element, whereas the igniting type contains a black-powder charge in the cup.

2. Construction. Grenade fuzes of the delay type consist of a body to which is attached the safety pull pin, safety lever, firing mechanism,

delay element, and detonator or igniting charge. A typical fuze is shown in Fig. 202. The contact type of hand grenade is discussed in Art. 5.

For functioning the fragmentation grenade filled with EC blank powder or practice grenades filled with black powder, an igniting-type fuze is used, either the M10A3 with lead spitter fuse delay, or the M205 with gasless fuze powder delay. For functioning the fragmentation grenade filled with TNT, the offensive grenade, and the bursting type (WP) smoke grenade a detonating-type fuze is used, either the M6A4 with lead spitter fuse delay, or the M204 with gasless fuze powder delay. For functioning the burning type of smoke grenade, a 2-sec. shorter igniting fuze, such as the M200A1, is used.

3. The delay element. Grenade fuzes of the fixed-time type contain a delay element to give a delay of about 4-5 sec. for defensive grenades, and as low as 2 sec. for some offensive grenades. The delay element formerly consisted of black powder, but the powder caused considerable trouble because of its hygroscopicity, and it was thought that prematures might result from improper loading or omission of the black powder. Lead spitter fuse, consisting of a preformed lead tube with a black-powder core that can be cut to length, was substituted for Bickford fuse to obtain improved action, and some fuzes are of this construction.

In an effort to correct other difficulties with the delay element, a non-gaseous fuze powder has been developed similar to the powder used in some tail bomb fuze primer detonators. A powder of the zirconium-nickel-barium chromate type has been successful. In a detonating-type fuze, the delay powder is followed by a relay charge for transmitting the flame to the usual azide upper charge and thence to the PETN or tetryol lower charge of the detonator.

Rifle Grenade Fuzes. Rifle grenade fuzes are of the impact type built into the body of the tail assembly, have a safety wire which must

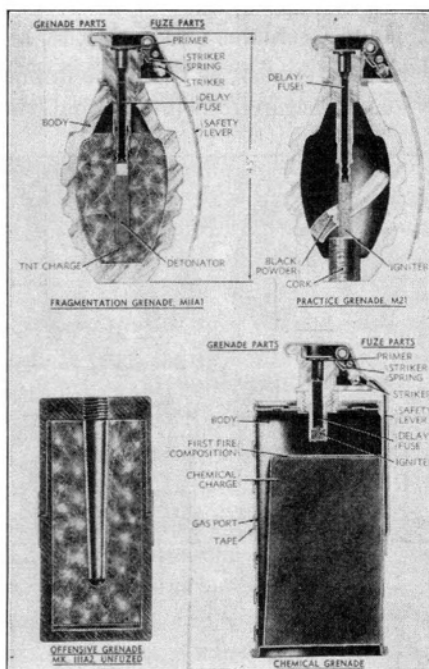

FIG. 203. Details of typical hand grenades.

be withdrawn before firing and the fuze functions on hitting a target by the forward inertia of the firing-pin element which compresses the creep spring and fires the detonator, as shown in Fig. 207. In addition, the standard hand-grenade types of fuzes are adapted to rifle grenades, as discussed in Art. 6.

5. Hand Grenades (Mk I, Mk II, Mk III, M6, M8, M14, M15, M21).

Hand grenades, as the name implies, are thrown by hand by the individual soldier in front-line combat, the range being 35 to 50 yd. The general types that will be discussed are fragmentation, offensive, chemical, smoke, and practice.

Fragmentation Grenades. The standard fragmentation hand grenade is the Mk IIA1, shown in cross section in Fig. 203, and in external view in Fig. 204. It consists of a serrated cast-iron body shaped like a large lemon (sometimes called a pineapple), is about 4.5 in. long and 2.25 in. in diameter and weighs 22 oz. At one time it was filled with a nitrostarch explosive consisting of 25% nitrostarch, 34% ammonium nitrate, and 40% sodium nitrate, and later with EC blank powder, both being substitutes for the unavailable TNT. The EC blank powder was initiated by the M10A3 igniting fuze.

The present filler is 1.9 oz. of a mixture of flake and granular

TNT, initiated by either the M6A4 or, preferably, the M204 fuze. Both fuzes are of the detonating type, the M204 incorporating several improvements over the M6A4 fuze, including the use of a non-gaseous fuze powder instead of black powder in the delay train. This, together with other new features, results in almost noiseless, sparkless, and smokeless functioning, except for the noise of the striker impact on the primer when the safety lever flies off. Thus the thrower is afforded greater protection in that his position is not so readily revealed to the enemy, particularly at night. The Mk IIA1 hand grenade can be thrown

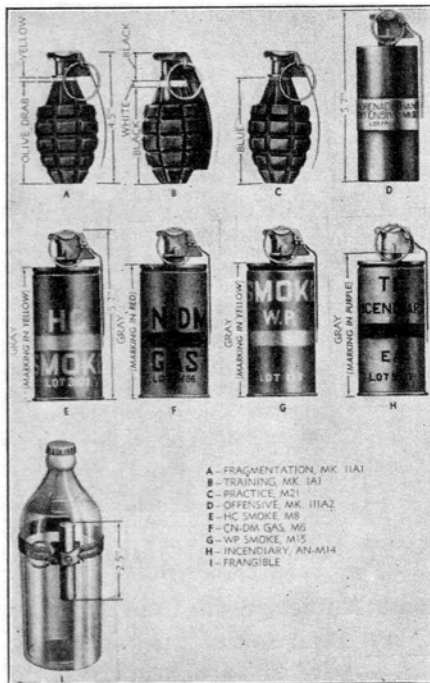

FIG. 204. Typical hand grenades.

about 35 yd. and produces about 50 to 60 fragments effective over a 30-yd. radius, although some fragments may travel as far as 200 ft.

Offensive Grenades. The standard offensive hand grenade is the Mk IIIA2, shown in cross section in Fig. 203 and in external view in Fig. 204. It is 5.7 in. long and $2\frac{1}{8}$ in. in diameter, and it weighs 14 oz. The body is of laminated paper and may have sheet-metal ends. It is filled with 6.8 oz. of pressed TNT and is functioned by the M6A4 or M204 detonating-type fuzes. It may also be functioned by placing a blasting cap on a piece of primacord in the fuze well cavity, thus forming an easily constructed booby trap.

Chemical Grenades. A typical chemical grenade, such as is shown in Fig. 203, consists of a light metal can filled with a suitable chemical and functioned by the M200A1 fuze, which is similar to the M10A3 igniting-type fuze except that the delay time is about 2 sec. The M6 and M7 grenades are filled with CN or DM gases; the M6 is shown in Fig. 204.

Smoke grenades are similar to chemical grenades; they are used for laying down a local smoke screen to hide troop movements or for other tactical purposes. They are available in the form of HC burning smoke, WP bursting smoke, and colored smoke. The AN-M8 HC burning smoke grenade is a light metal can filled with 500 grams of HC smoke mixture, the can having holes in the sides and top through which the smoke is emitted. It is functioned by the M200A1 fuze of the short variety, and is shown in Fig. 204. The M15 WP smoke grenade is of the bursting type, has the same general construction as other smoke grenades, and is functioned by the M6A3 detonating fuze; it is shown in Fig. 204. The M16 colored smoke grenade is also similar and is available in green, red, violet, yellow, blue, orange, and black.

The AN-M14 is an incendiary grenade of the same construction as chemical grenades except that it is filled with incendiary mixture; it has the M200A1 fuze. It is shown in Fig. 204.

The M3 frangible grenade, Fig. 204, is of the improvised type made by filling a glass bottle with chemicals and attaching an igniter to the side of the bottle.

Illuminating Grenade. In order to investigate suspicious noises at night, an illuminating hand grenade has been developed. It is similar to the hand illumination flares discussed in Art. 8, Chapter 10.

Practice Grenades. Figure 203 shows the M21 practice grenade, similar to the Mk IIA1 except that the charge is black powder, the fuze is an igniting type like the M10A3, and the base of the body has a cork plug that blows out to give an indicating smoke puff so that the thrower can check his accuracy. The Mk IA1 training grenade, totally inert, is shown in Fig. 204.

6. Rifle Grenades (M9, M11, M17, M19).

Description and Uses. In an effort to increase the range of the hand grenade without the necessity for any special equipment or apparatus, grenade launchers have been developed which fit over the muzzle of the standard caliber .30 rifle or carbine and allow rifle grenades to be fired from them. The range of the grenade is thus increased from about 35 yd. to 300 or 600 ft. without requiring the soldier to carry any additional equipment except the GRENADE LAUNCHER. Grenades so fired are called RIFLE GRENADES. The range is controlled by the distance the grenade is placed on the launcher, clips being provided on the launcher to permit the tail of the grenade to slip over it the desired amount.

Rifle grenades are of three types: a hand grenade permanently fastened to a stabilizer tube and having a built-in inertia fuze instead of the usual hand-grenade fuze; assemblies made in the field, consisting of hand grenades attached to grenade projection adapters; and the anti-tank rifle grenade, similar to the first type except that the hand grenade is replaced by a high-explosive head employing the shaped-charge principle. Inside the tube a special blank cartridge for the rifle or carbine is carried, and it is retained in the rifle grenade by a cork plug. The special cartridge is fired instead of the usual rifle bullet to project the rifle grenade, which can be aimed much more accurately than the grenade can be thrown, even though the rifle is not fired from the shoulder. By means of an auxiliary grenade cartridge, Fig. 36, increased velocity and range are obtained.

The M1 grenade projection adapter adapts the standard hand grenade Mk IIA1 to the rifle or carbine in the event that the M17 rifle grenade is not available. It functions by setback, causing an arm to move back, thus releasing the usual hand safety lever of the grenade.

Fragmentation Rifle Grenades. The M17 fragmentation rifle grenade consists of the Mk IIA1 hand grenade, attached to a stabilizer tube and fin assembly, and functioned by an impact fuze at the base of the grenade. A safety pull pin passes through the stabilizer tube, preventing the plunger from hitting the detonator until it is removed, and the plunger is driven forward at impact to compress the creep spring and fire the detonator and a tetryl booster. The grenade weighs 25.3 oz., contains 0.77 oz. EC blank powder, and has a range of 136 yd. at 121 ft./sec. when fired from the carbine, and 200 yd. at 146 ft./sec. when fired from the rifle.

The same result is obtained by combining the M1 grenade projection adapter with the Mk IIA1 hand grenade, as in Fig. 205. The adapter is a tail fin and stabilizer assembly having four claws at the front end to hold the grenade body. The claw has an arming clip to hold the safety

lever until released by setback, after which the lever flies off and the grenade functions after the usual delay.

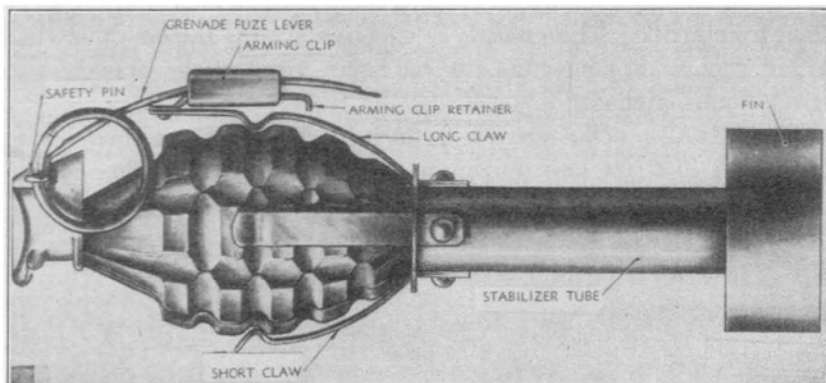

FIG. 205. Fragmentation hand grenade in adapter for rifle projection.

Antitank Rifle Grenades. Figure 206 shows the M9A1 antitank rifle grenade, based on the shaped-charge principle and functioned by an impact fuze the same as the M17 rifle grenade. The antitank grenade weighs 1.23 lb. and is 11.2 in. long and 2.15 in. in diameter. The charge

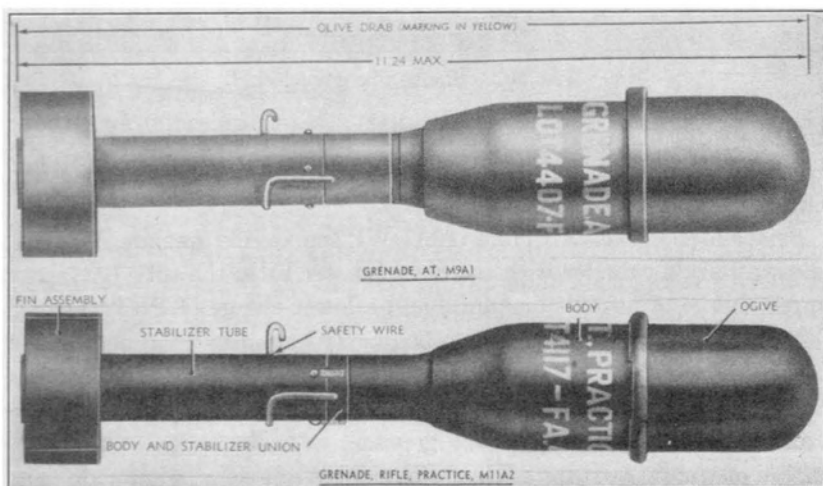

FIG. 206. Antitank rifle grenades.

is 4 oz. pentolite back of the steel conical liner. A false round ogive which breaks upon impact protects the front of the grenade. The carbine allows a range of 184 yd. at 143 ft./sec. and the rifle 257 yd. at 175 ft./sec.

This rifle grenade gives the foot soldier some chance against a light tank or a vulnerable part of even a heavy tank; it is the first device that allows ammunition capable of piercing more than an inch of armor to be fired from a rifle. The grenade is effective against targets other than armor, such as machine-gun nests, pill boxes, fortifications, or even as an antipersonnel grenade.

The M11A2 practice grenade is an inert dummy grenade similar to the M9A1 in shape and weight, but it has a replaceable fin, since in

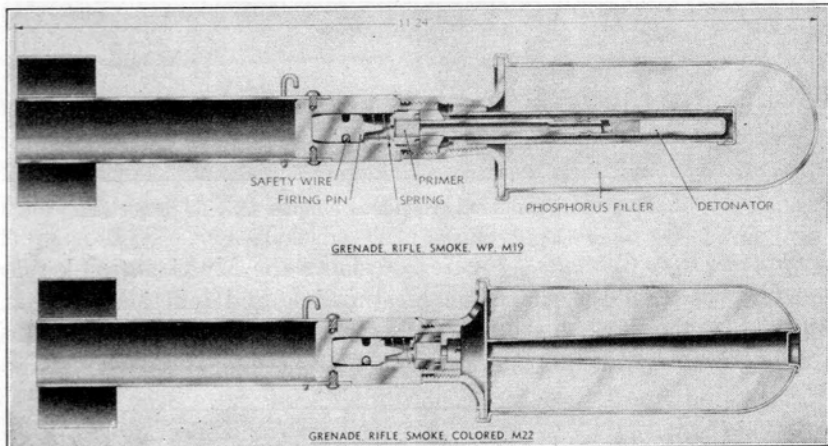

FIG. 207. Smoke rifle grenades.

practice work fins become worn or bent. It is usually made of a cast-iron body, and gives the soldier practice with the grenade launcher and rifle grenade. It is shown in Fig. 206.

Smoke Rifle Grenades. The M19A1 WP smoke rifle grenade, Fig. 207, is essentially a cylinder with a central burster tube, the tube having an upper charge of hexanitromannite and a lower charge of PETN, which results in bursting of the grenade body. It is 11.3 in. long and weighs 1.57 lb. It contains 8.5 oz. of white phosphorus. The M20 HC smoke rifle grenade is similar except that a booster pellet is set into the high-explosive filler at the top of the grenade, in order to ignite the high-explosive smoke mixture. The M22 colored smoke rifle grenade, Fig. 207, is similar to the M19A1 smoke grenade and is available in red, yellow, violet, and green. It is for signaling, and it is functioned by the M203 fuze of the igniting type. It contains 6.9 oz. of colored smoke mixture and burns for 45 sec. after impact, giving a dense cloud through emission holes in the base of the grenade.

MINES

7. Description and Uses.

Mines are commonly associated with the defense of a territory, in that an area being evacuated is mined so that the enemy will be hindered and slowed down in occupying it. In this respect they differ from other ammunition and weapons that require the actual presence of troops to operate them, for mines are operated by the enemy against himself and are a hazard to him 24 hours a day. **LAND MINES** are placed on land or just beneath the surface, to inflict damage on either personnel or equipment. They are of the trap type, being initiated by unsuspected action of the enemy. If they are for the purpose of destroying vehicles, trucks, and tanks, they are called **ANTITANK MINES**, and if they are directed against personnel they are called **ANTIPERSONNEL MINES**. **BEACH DEFENSE MINES** are laid just under the water to defend beaches against landing craft. Since all mines, but particularly antipersonnel mines, can be hidden in a great variety of places and can be actuated in a variety of ways, some are called **BOOBY TRAPS**, because the "boob" or unsuspecting soldier may sit on something, pick something up, step on something, or trip over a wire, any one of which actions may actuate the mine or booby trap. They are laid near barbed wire, walls, evacuated houses—almost anywhere; their damage is usually to one or two soldiers, which hardly slows down the war. But they make life miserable, break morale, slow down advances and occupation of captured territory, and distinctly discourage souvenir collecting.

Antitank mines consist of a container for holding an explosive charge and a suitable means of activation: a fuze which functions when a minimum predetermined load passes over the mine, or an activator functioned by cutting or pulling a wire, or some other means. The bodies are of either **METALLIC** or **NON-METALLIC** constructions, the non-metallic defeating detection by the electromagnetic mine detector. In addition, antitank mines may be of the **HIGH-EXPLOSIVE** or **PRACTICE** types.

Antipersonnel mines are of the straight demolition type, similar to antitank mines, or of the fragmentation or "bouncing Betty" type wherein a projectile flies up in the air from the ground and detonates a few feet from the ground, spraying fragments in all directions. Booby traps not only can be constructed of antipersonnel mines but also can be improvised from demolition charges, shell, or any container to hold an explosive charge, and activated by any firing device.

It is customary to provide cavities in the sides and bottom of mines, as shown in Figs. 209 and 210, into which **ACTIVATORS** may be screwed. Mines may be functioned by the enemy when he trips over a wire

attached to an activator, or tries to pick up the mine, thus functioning the bottom activator if it is anchored down. The Corps of Engineers standard firing devices may be used to activate mines.

8. Antitank Mines (M1, M4, M5, M6, M7).

High-Explosive Mines. The M1A1 was formerly the standard mine. It consists of a sheet-steel flat cylindrical container 8.2 in. in diameter and 4 $\frac{1}{4}$ in. high, weighing 10.67 lb. total, and containing 5.83 lb. of cast TNT. The fuze, Fig. 208, is really a firing mechanism with detonator on top of

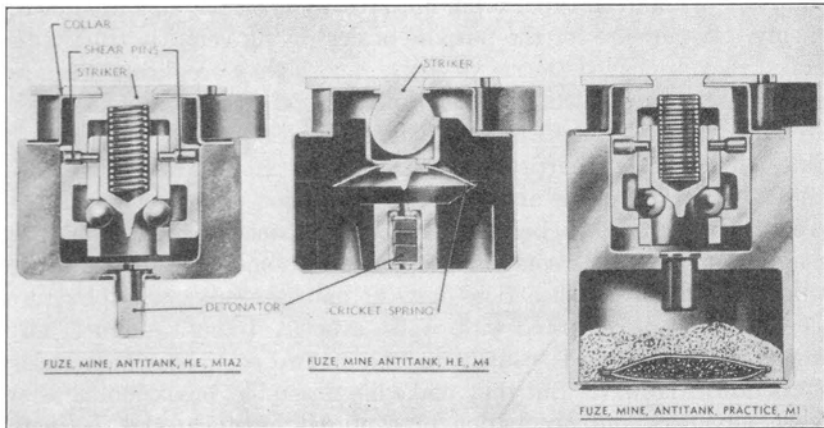

Fig. 208. Antitank mine fuzes.

a booster, the booster being shipped in the mine and the fuze being assembled in the field for safety. A fork with a cord attached is fitted over the fuze collar under the striker head and is removed to arm the fuze. The firing pin is held away from the detonator by two steel balls, but, when pressure is applied to the striker through the spider over the mine body, two pins are sheared and downward movement of a sleeve releases the balls, which are forced outward. A pressure of 500 lb. on the striker will function the fuze, but only 250 lb. applied to the outside of the spider is necessary because of the lever action. This mine is designed to be functioned by trucks and tanks but not by personnel.

The M4 mine is like the M1A1 except that the fuze, Fig. 208, is of the cricket or Belleville spring type, supporting the firing pin, and the mine has side and bottom activation. After the safety fork is removed, a pressure of 250 lb. on the spider "snaps the cricket" and drives the firing pin into the detonator. This is really a type of cocked-firing-pin activator.

Because the M1A1 and M4 mines do not have sufficient charges to wreck heavy tanks, a heavier mine with a 12-lb. TNT or tetrytol charge was developed, similar to the German Tellermine, except that the design has been greatly improved. This mine is a flat pancake type weighing

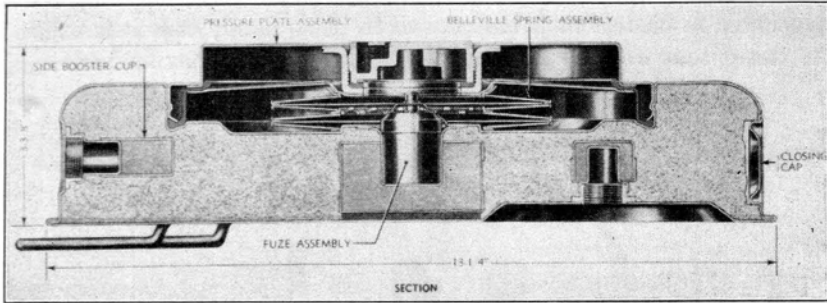

FIG. 209. M6A1 heavy metallic antitank mine.

20 lb., total, and is functioned by a gradually applied load of 375 lb. to the Belleville type springs, as in Fig. 209. The shipping plug is so designed that, when it is screwed in the top of the mine in shipping position, pressure on the mine does not crush the ampoule of the M600 chemical fuze, but, when the mine is reversed to the armed position, pressure applied does function the fuze. Furthermore, the mine is so

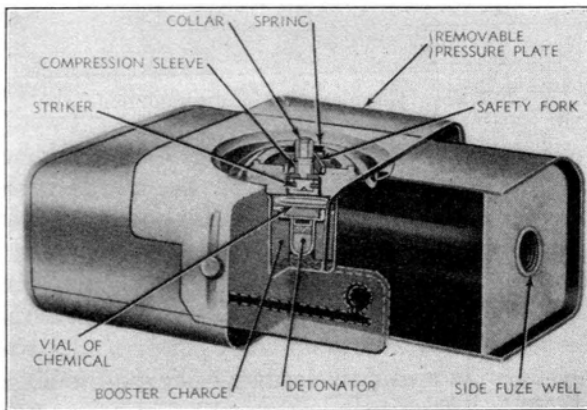

FIG. 210. M7 light metallic mine.

designed that a suddenly applied load, such as a blast from detonation of a nearby mine, will not function the fuze because of trapped air in the movable part of the mine. This mine has both side and bottom activation.

The M7 is a light mine, Fig. 210, consisting of a light metal can with the M601 chemical fuze, Fig. 211. It weighs $5\frac{1}{2}$ lb., contains $3\frac{1}{2}$ lb. tetrytol, and is functioned by a 150-lb. load, so that it is an antipersonnel mine but can do damage to light vehicles as well. It is sometimes called a "hasty" mine, as it was intended to plant it over territory being evacuated in haste, but it has proved to be so handy that it is utilized for demolition work as much as antitank work. It has an activating

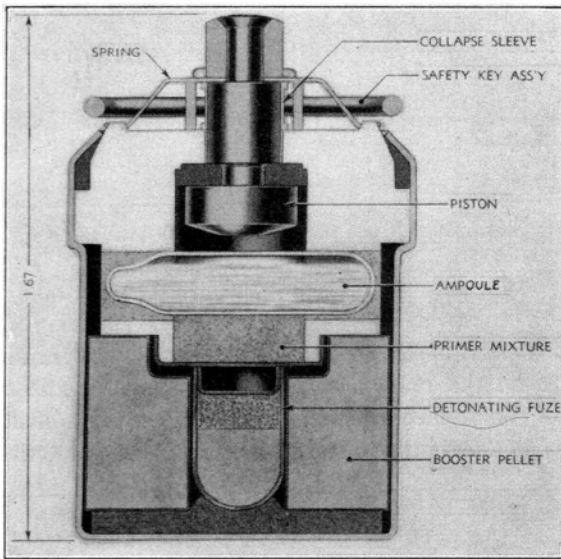

FIG. 211. Chemical fuze for antitank mine.

well for use with a blasting cap, and late models are designed to take the grenade bouchon as a firing device. The pressure plate has a rubber pad over the fuze so that quickly applied loads do not function the mine as well as steadily applied ones.

Practice Mines. The M1B1 is an adaptation of the M1A1 and M4 mines for practice work. The body has five holes cut in the top, and the booster is replaced by a 60-grain black powder and a 100-grain red phosphorus charge, the rest of the loading being sand to obtain the correct weight. The practice fuze is shown in Fig. 208. Both the M6 and M7 mine are made in the practice types.

Non-Metallic Antitank Mines. In order to defeat detection by the electromagnetic detector, a mine has been developed containing no metals. Known as the M5 non-metallic antitank mine, it consists of a glass or china body containing 5.4 lb. TNT or tetrytol, a rubber compression ring, and a plastic fuze having a glass chemical ampoule over

oose primer mixture, and is held together by asphalt-impregnated heavy paper and waterproof tape. The mine requires 350 lb. to function it, and it weighs 15 lb., somewhat more than the M4 or M1A1 mines containing the same quantity of explosive. It is provided with bottom activation.

This mine alone, or mixed with metallic mines to form a mine field, is very effective in slowing down mine clearance.

9. Antipersonnel Mines (M2, M3).

Description and Uses. There are three types of antipersonnel mines, depending upon their method of functioning: the demolition block type, consisting of a demolition charge in a suitable container, and functioned with a suitable activator; the "bouncing Betty" type, which shoots a high-explosive projectile a few feet in the air to detonate by delayed action; and the strictly improvised type, consisting of any container with a high-explosive charge and activator arrangement, usually cleverly concealed and activated, and called a booby trap.

The booby trap is not a device to accomplish demolition on a large scale, and no war can be won by means of booby traps even in large quantities. They are more important from the standpoint of the effect on the state of mind of the enemy than because of the actual number of casualties they produce. But since they detonate unexpectedly against the soldier when he is relaxed or working on a routine assignment, they force the enemy, by a series of confusing and terrifying experiences, to live in uncertainty and dread.

Firing Devices. Firing devices are for activating booby traps, antipersonnel mines, certain antitank mines, and demolition devices. They are of standard design, safe to operate, and easily installed. The non-electrical design is more common, and it may be of the pull, pressure, release, or combination type.

1. Pull type. This type is actuated by a 3- to 5-lb. pull on wire, which releases a cocked firing pin, which is then spring-driven into the percussion cap. Actuation may be by lifting or pulling some object tied to the pull wire, or by tripping over the wire tied to some fixed object at the end opposite to the device. This firing device is about $4\frac{3}{4}$ in. long and $\frac{5}{8}$ in. in diameter, and it has two safety pins that must be removed before the device is ready to fire. One pin passes through the firing pin itself and the other through the body, either one serving to prevent firing.

2. Pressure type. This type of firing device operates by a 30-lb. minimum pressure applied to the pressure pin, under which is a safety clip that must be removed before the device is ready to fire. The trigger spring is compressed by the load, thus releasing the cocked firing pin.

Such a device is put in booby traps or antipersonnel mines and is operated by a soldier stepping on the pressure pin, concealed under leaves or a few inches of dirt.

3. Release type. This type operates when pressure is removed. It is a cube-shaped device $2\frac{7}{8}$ in. by $1\frac{7}{8}$ in. by $1\frac{7}{8}$ in., and it requires a 2-lb. load

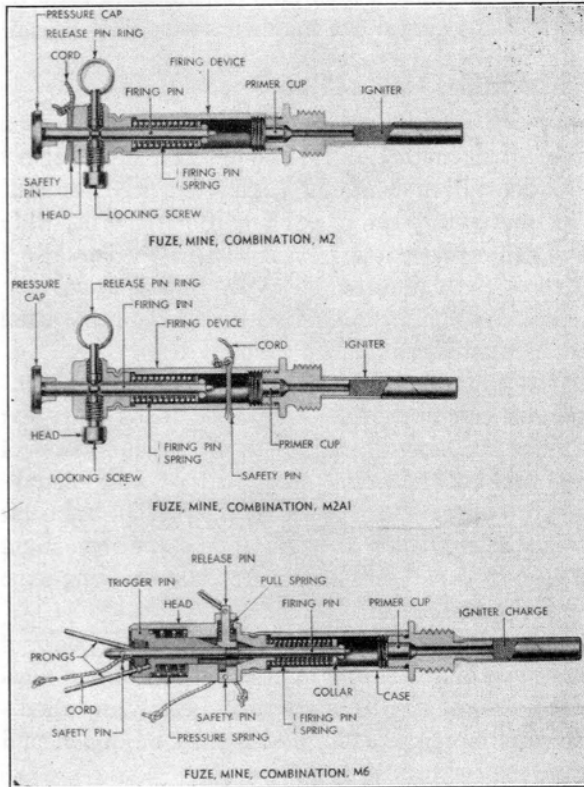

FIG. 212. Firing devices for mines and booby traps.

to keep it from firing, once the safety pins are removed. Then, when some object is picked up, as in souvenir collecting, the mechanism is released, firing the booby trap or demolition charge.

4. Combination type. There are several combinations of the three basic types, the most common being a combination of the pressure and pull varieties, such as those shown in Fig. 212, which is used in the "bouncing Betty" antipersonnel mine and is adapted to other devices also. It requires a 3- to 5-lb. pull or 20- to 40-lb. pressure to function it. Another combination consists of the pressure and pull types with the addition of a wire-release feature, so that either a pull on a wire or

cutting the wire functions the device. The M49 trip flare is actuated by a firing device which functions when the wire is cut or pulled.

Demolition Type. The M3 antipersonnel mine is of the demolition-fragmentation type, consisting of a hollow cast-iron block, weighing

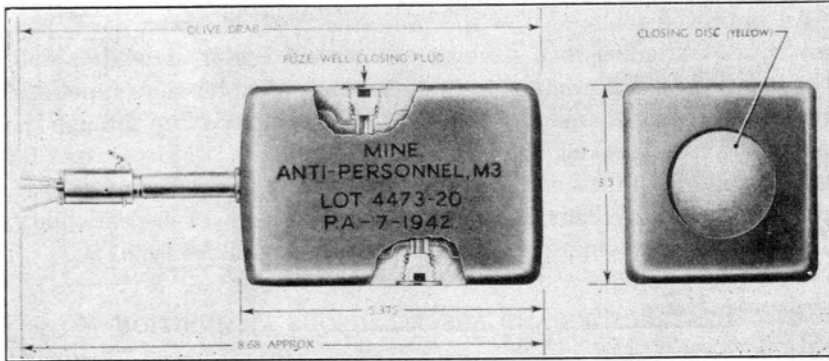

FIG. 213. Demolition-type antipersonnel mine.

10 lb. and filled with 0.9 lb. of flake TNT. It is really a small trap-type land mine for use against personnel, and its fragments are effective over a 10-yd. radius when it is detonated on the ground, more when detonated off the ground, and less when buried. There are three wells for activators or blasting caps, and the mine is impervious to the weather. It is 3.5 in. square by $5\frac{3}{8}$ in. long, and is shown in Fig. 213.

Projectile Types. The M2A4 mine, Fig. 214, is a metal body consisting of a combination pressure- and pull-type firing device and an expelling charge chamber. The projectile is a 60-mm. mortar shell weighing 2.1 lb. and filled with 0.34 lb. of TNT. When the activator is functioned, the expelling charge of 0.003 lb. black powder is ignited, which not only propels the projectile in the air but also

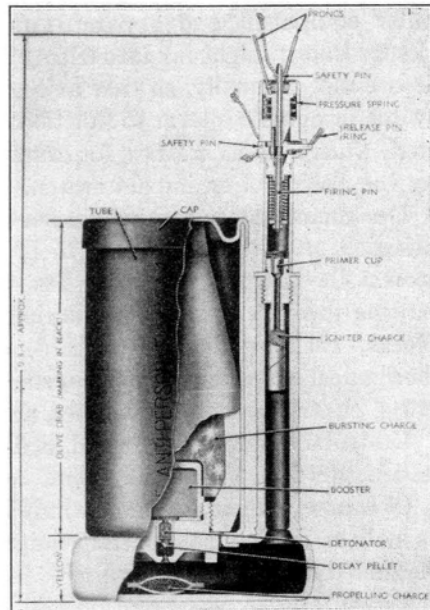

FIG. 214. Projectile-type antipersonnel mine.

ignites a 0.4-sec. delay element in the bottom of the projectile, so that when it is 2 to 7 ft. in the air it detonates. The complete mine is about $9\frac{3}{4}$ in. high and 4 in. wide, weighs 5 lb., and is effective over a 30-ft. radius, some fragments traveling up to 400 ft. Projectile-type anti-personnel mines are sometimes called "bouncing Betty" mines.

An improved mine, also of the projectile type, has been developed, but is self-contained in a packing can with a center activation well. The top of the can is crimped to the sides, and, when the mine functions, the base-expelling charge pushes the cast-iron mine body up through the top of the can, breaking the crimp. The mine has two detonators for dependability of functioning, and the detonation takes place 4 to 6 ft. from the ground. This mine has the advantages of dependability, accuracy, waterproofness, and simplicity over the M2A4 type.

DESTRUCTORS AND MISCELLANEOUS AMMUNITION

10. Destructors (M1, M2, M3, M4, M5, M6, M7).

General Description and Uses. DESTRUCTORS are components for demolishing or destroying certain pieces of equipment under controlled conditions, particularly confidential equipment, the nature and operation of which it is desired to keep from the enemy. Certain radio and radar equipment and apparatus must be destroyed if there is any chance that it might fall into enemy hands. These destructors are operated either manually, so that at a given time the operator can close a switch or operate a lever to function the destructor, or automatically, so that, when a plane crashes, for example, certain equipment is destroyed by the closing of an impact switch.

Destructors are sometimes tailor-made pieces of apparatus, usually designed after the equipment to be destroyed is completely designed, so that the destructor designer has to exercise considerable ingenuity in putting together certain ammunition components like fuzes, demolition blocks, Bickford fuse, primacord, detonators, igniters, with certain mechanical and electrical devices such as sheet-metal platforms and supports, electric jacks and switches, and flexible shafts.

Destructors may be classified as destructors for radio equipment and destructors for control equipment.

Of course, control equipment may include radio and radar equipment, as well as mechanical control equipment, both being used extensively on guided missiles.

Destructors for Radio Equipment. These are simple in construction and are electrically fixed explosive charges, producing a demolition effect. They are usually operated by a 6-volt battery.

The AN-M1 destructor, Fig. 215, a small tabular detonator-type destructor $1\frac{3}{8}$ in. long and 0.5 in. in diameter, is screwed into an adapter or well by means of the screw driver slot. The head contains nitrocellulose fired by a resistance wire when the circuit is closed either manually

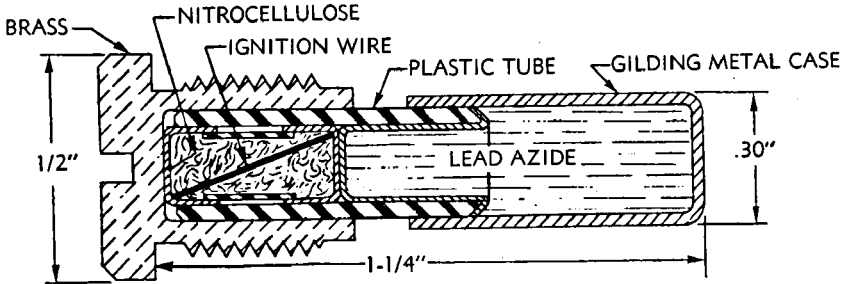

FIG. 215. M1 destructor.

or by an inertia switch. The tube contains lead azide, having just the right amount of power to destroy the vital and confidential parts of the radio without being harmful to nearby personnel. Several are connected in parallel in each set.

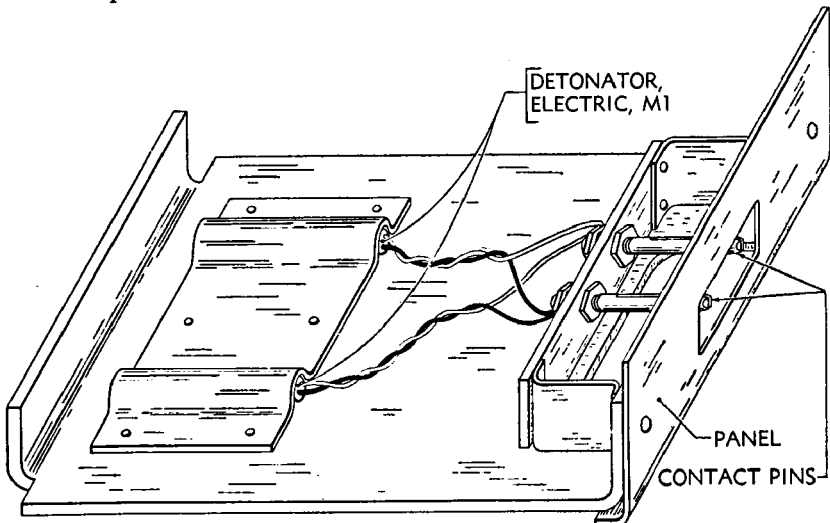

FIG. 216. M2 destructor.

The AN-M2 destructor shown in Fig. 216 serves the same purpose. It consists of a sheet-metal support $5\frac{3}{4}$ in. by $3\frac{5}{8}$ in. on which two electric detonators M1 are mounted, each detonator being 1.5 in. long and 0.25 in. in diameter, and connected in parallel by two electric jacks.

The AN-M3A1 destructor is a larger single-unit, tubular-type destructor, 6.2 in. long and $1\frac{1}{8}$ in. in diameter. The head consists of a jack having two electric connectors in the body, followed by a tetryl pellet, which blows a steel slug with considerable force into the particular part of the radio equipment to be destroyed. It is shown in Fig. 217.



Fig. 217. M3A1 destructor.

The M6 and M7 are two destructors, identical except that the M6 is a little larger with more power than the M7, for destroying radio equipment carried by a paratrooper if he is in danger of being captured or wishes to dispose of his equipment. They consist of a friction-igniter

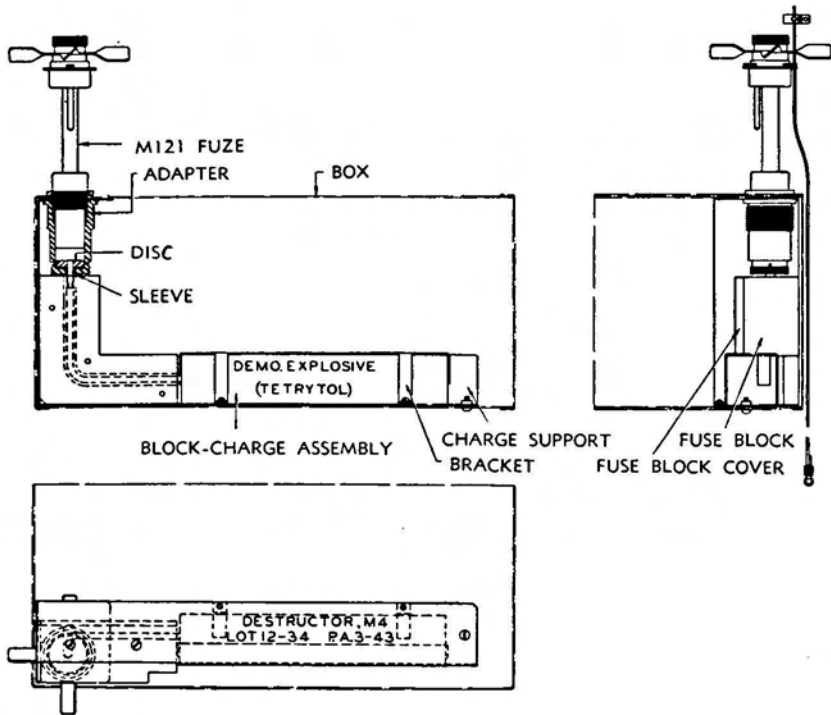

Fig. 218. M4 destructor.

head assembly, followed by a 5-sec. delay of Bickford fuse, and an azide-tetryl detonator. They are initiated by pulling the $3\frac{1}{8}$ -in.-long friction wire, and the delay gives the operator a chance to retire to a safe distance, though the disruptive effect is not dangerous to personnel.

The M7 destructor is 3.8 in. long and 0.27 in. in diameter; the M6 is a little larger.

Destructors for Control Equipment. This type of destructor usually consists of a modification or variation of some bomb fuze, fitted with a non-delay primer detonator to give functioning at the instant the missile or device crashes or lands, together with some demolition device so placed as to accomplish the desired effect. The two are mounted on some type of frame or bracket or arm, and since they may not be in line a flexible connector between the two is required. Also, since the fuze must be in the air stream to arm, and the demolition part of the

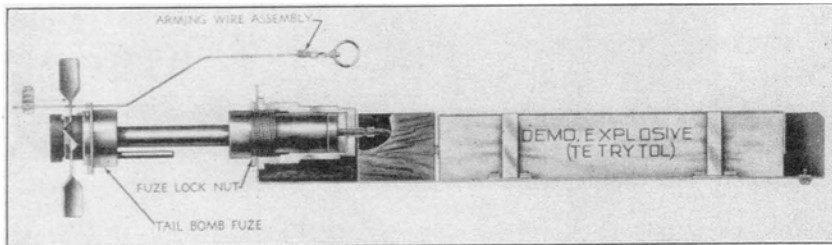

FIG. 219. M5 destructor.

destructor may be inside the missile or device, the two parts of the destructor may be separated by several feet. No effort will be made to describe the great variety of such destructors, but the M4 and M5 may be taken as typical.

The M4 destructor, Fig. 218, is designed to destroy the control equipment of a glide bomb as soon as it lands, so that, if the main bomb charge does not detonate, at least the enemy will not learn the method of controlling the flight apparatus. It consists of the M121 fuze, which is really the M115 fuze fitted with a non-delay primer detonator but retaining the cocked-firing-pin sensitivity feature, as the bomb may glide in without much impact and the delayed arming feature is used because a glide bomb provides a long arming period. The fuze is connected to a $2\frac{1}{2}$ -lb. tetrytol demolition block by primacord, and all are mounted on an L-shaped frame $18\frac{5}{8}$ in. by $8\frac{1}{8}$ in. by $3\frac{1}{2}$ in. The fuze is at right angles to the demolition block.

The M5 destructor, Fig. 219, is to destroy the control equipment of a glide torpedo. It consists of a tail bomb fuze and a tetrytol demolition block mounted on a bracket. Other such destructors are connected to the fuze by a flexible shaft or other arming mechanism, and the brackets and frames are built in a variety of sizes and shapes to fill particular requirements.

Figure 220 shows the M1, M2, M3, and M4 destructors, so that their comparative size may be seen.

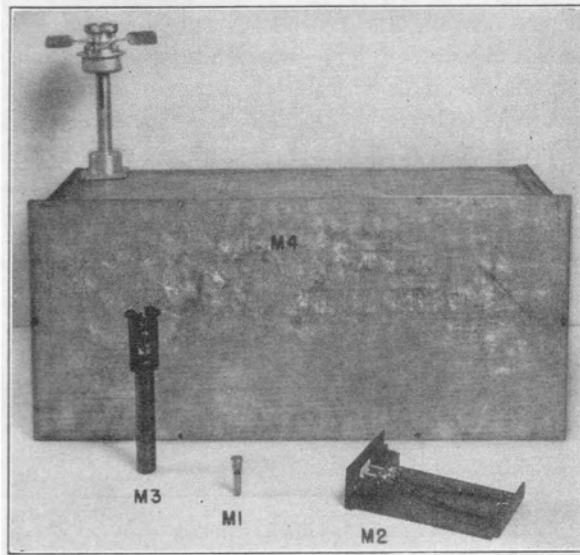

FIG. 220. Various destructors.

11. The M1 Bullet Impact Fuze.

The M1 bullet impact fuze, Fig. 221, was designed by the Ordnance Department to initiate a Corps of Engineers demolition device by firing

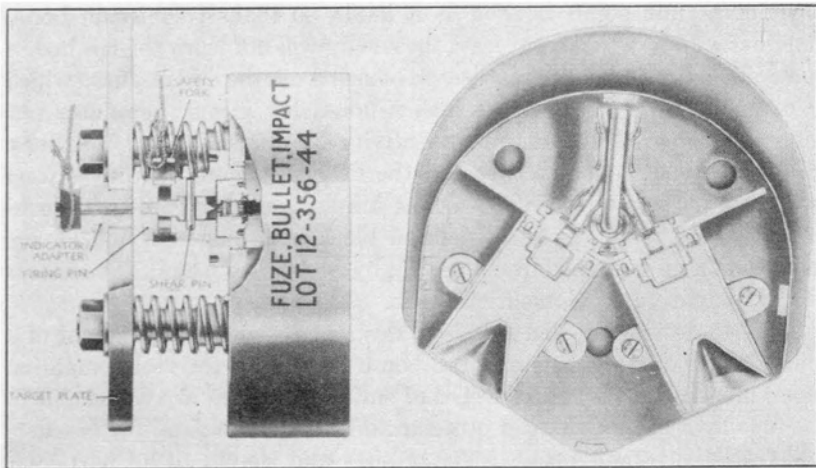

FIG. 221. M1 bullet impact fuze.

a caliber .30 rifle bullet at the fuze, which is a target as well as an explosive initiating device. The target area is a steel plate, $\frac{3}{8}$ in. thick and about 6 in. in diameter, which moves backward against spring action when the bullet hits it. This motion causes the firing pin to shear a pin and function a detonator, and the primacord to function twin detonators which initiate two shaped-charged booster elements which function the land snake.

12. Demolition Devices.

A number of ammunition components containing explosives have been developed for demolition work. They include the bangalore torpedo for

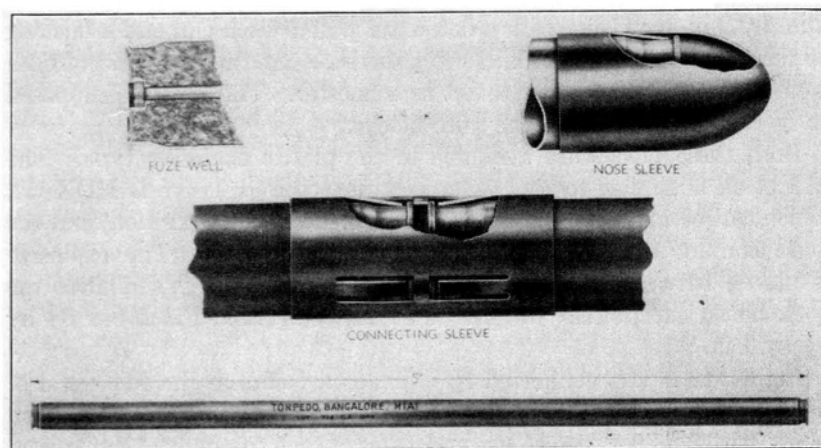

Fig. 222. M1A1 bangalore torpedo.

clearing wire entanglements and mine fields, demolition blocks for general demolition work of both the conventional and shaped-charge varieties, and special devices developed by the Corps of Engineers which will not be discussed here. Demolition explosives are usually initiated by electric or non-electric blasting caps, in connection with safety fuse or primacord. The common firing devices may be used, particularly when demolition blocks are employed as booby traps. Demolition explosives must not be too sensitive to shock or friction, must have a high rate of detonation and brisance, and must be easily detonated and stable.

Bangalore Torpedo. The standard M1A1 bangalore torpedo shown in Fig. 222 consists of a steel tube 5 ft. long and $2\frac{1}{8}$ in. in diameter, filled with 9 lb. of amatol or other high explosive, topped off by 4 in. of TNT at each end. Each end is capped and grooved and contains a fuze well to accommodate a detonator, primacord, or blasting cap attached to any

of the standard firing devices. Torpedoes may be fastened together by connecting sleeves for different purposes such as blasting entanglements, clearing mine fields, and general demolition work. They may be used as antitank and antipersonnel mines and booby traps. A nose sleeve is provided for ease in pushing the torpedo through obstacles.

Demolition Blocks. A $\frac{1}{2}$ -lb. rectangular TNT demolition block $1\frac{3}{4}$ in. square and $3\frac{1}{4}$ in. high has long been used for demolition work, for improvised mines and booby traps, and for ammunition destruction. The TNT is contained in a treated cardboard container with tin ends, with a cylindrical hole about 2 in. deep in each end, into which primacord or a blasting cap may be inserted.

The M2 demolition block is a $2\frac{1}{2}$ -lb. tetrytol (75% tetryl) block 2 in. by 2 in. by 11 in., with a detonator well at each end and a bushing to receive any of the standard firing devices. At the inner end of each well is a small tetryl pellet to act as a booster. This block is supposed to be equivalent to six of the $\frac{1}{2}$ -lb. blocks.

Both these blocks are available in the plastic explosive type. The M3 block is similar to the M2 except that the explosive is RDX-C2, which can be molded by hand to any desired shape or position, and the good contact thus obtained increases the efficiency. The explosive is plastic between -20 and $+125^{\circ}$ F. The M4 block is similar to the $\frac{1}{2}$ -lb. block, except that the plastic explosive is packed in a box $6\frac{3}{4}$ by $1\frac{1}{2}$ by 1 in.

Eight M2 blocks connected by primacord comprise the M1 chain of demolition blocks. The primacord passes through the axis of each block, with 8 in. between blocks and 24 in. at each free end. A cylindrical tetryl pellet is cast into each end of each block to act as a booster, and the blocks are enclosed in impregnated-paper wrapping. The entire chain is packed in a lightweight haversack, the blocks can be laid in line, wrapped around an object, or detonated in the haversack.

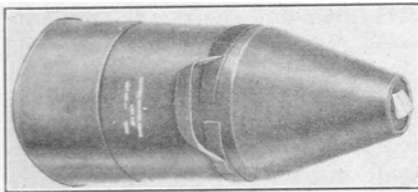

FIG. 223. M2A3 10-lb. shaped-charge demolition block.

The 10-lb. M2A3 shaped-charge demolition block is shown in Fig. 223; 35-lb. blocks have been used.

They consist of a shaped-charge unit in a container and a detonator well in the conical end opposite to the shaped charge. They are placed in position with the shaped charge against the object which it is desired to puncture or demolish. Of course, these units give a directional demolition effect with penetration, rather than a general effect in all directions.

PART VIII
AMMUNITION PACKING

CHAPTER 13

AMMUNITION PACKING

1. Purpose and Necessity.

In the preceding chapters we have described hundreds of ammunition items of every conceivable size and shape for every conceivable purpose in war. Some of these items cost a few cents and others cost thousands of dollars apiece; some are rigid and can be thrown around without much chance of damage, such as a 500-lb. bomb, while others are extremely sensitive and fragile, such as delicate fuzes; some are complete in themselves ready to fire, and others consist of one part of an assembly and need other parts with them. If we go to the effort and trouble in time of war to design, develop, procure, manufacture, inspect, and ship ammunition to the Air and Ground Forces, the least we can do is see to it that it is packed right, so that it is serviceable when called upon to do its job. It is a tragic thing to design, manufacture, and ship an expensive bomb fitted with a very expensive and complicated fuze, have a plane carry it thousands of miles to the target, and then have a dud when it is dropped because a little moisture caused deterioration of a two-cent primer because it wasn't packed right!

2. Requirements of Satisfactory Packing.

General. Satisfactory packing is packing that protects the ammunition until the time comes for its use, no matter what the handling, storage, and shipping conditions may have been up to that point. It is quite true that we may not be able to supply such packing because of design or material limitations. But the packing designer must always have in mind the possible temperature range of -65° to $+170^{\circ}$ F., the possible variations from 0 to 100% relative humidity, the worst possible handling conditions such as dumping a box on its corner on concrete from a considerable height during unloading, the possibility that the ammunition may lie out in the pouring rain unprotected for long periods of time, vibration conditions during weeks or months of shipment, and exposure to sea water for long periods.

The time element is all-important. Ammunition was stored for 25 years between World War I and World War II, and some of it was still serviceable. Permanent packing should be designed with a 20-year interval in mind. On the other hand, the exigency of the situation may dictate that packing for ammunition to be used in a few weeks should be designed without considering any long storage period. Ammunition to be flown to a theatre for immediate use may not require such careful packing.

Of course, ammunition for use in the United States will not be subjected to extreme tropical conditions, and packing designs will take this into account. During a war a tremendous amount of interplant shipment takes place in the United States and such packing is not permanent in nature. Then there is that type known as emergency packing, which is done on the spot with whatever materials are available in order to meet a deadline.

It is not possible to duplicate all these requirements by laboratory testing, but a good rule for the packing designer is: make it too good rather than not good enough.

Of course, all packing containers are manufactured and marked in accordance with Army Regulations, Specifications, and I.C.C. Regulations.

We can now define AMMUNITION PACKING as the study of securing ammunition components in suitable containers, boxes, crates, drums, etc., for transportation and storage under the expected conditions and for the expected times. This type of packing, therefore, comprehends a study of all types of containers, including wood, fiber, metal, and plastic; boxes, both wood and metal; crates, both wood and metal; steel drums; pallets of all types; fiberboard boxes and cartons; paper, rubber, and cushioning materials of all kinds; waterproofing methods and materials; wax dipping, impregnating methods and materials, moisture and moisture-vapor barrier materials and methods; sealing materials and methods; and last, but not least, a knowledge of ammunition and its construction in order to design to protect the weaknesses. Furthermore, the ammunition-packing designer must provide for convenience in handling, storage, transportation, issue, and use of ammunition, and he must forever have in mind the fact that good packing is safe packing. The hazardous element must be considered with the other requirements, so that, if one little lead azide relay element detonates in one fuze in a box, the entire contents will not detonate. The ammunition-packing man has a tremendous responsibility, and our modern packing attests to the way he has discharged it.

Figure 224 gives some idea of the variety and complexity of modern ammunition packing.

Relative Importance of Factors. Specifically, the packing designer must always have in mind the requirements of satisfactory packing and their relative importance. The most important requirement for packing some commercial article may not be the most important requirement for a particular type of ammunition, and one type of ammunition may require emphasis on a requirement not so important in packing another type.

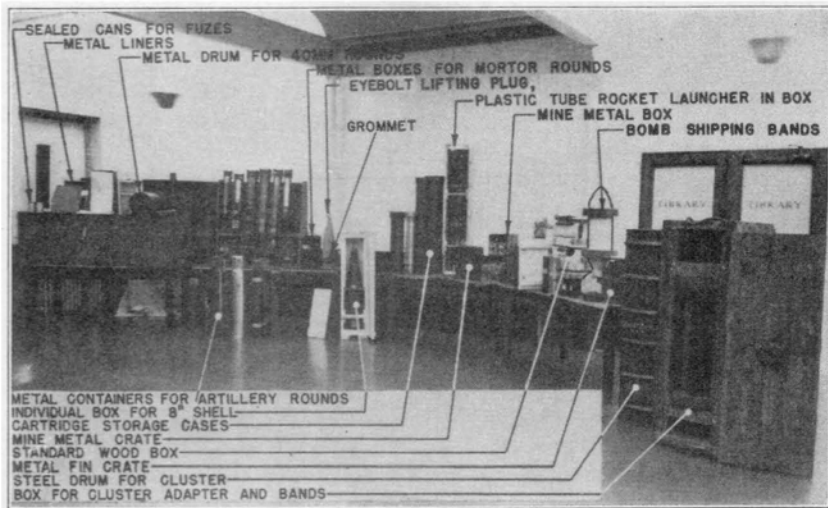

FIG. 224. Typical ammunition packing.

When designing cartridge storage cases for propellant powder, the primary requirement is moistureproofness. When designing containers for delicate bomb fuzes, the primary requirement is protection against shock. In general, these are the requirements of ammunition packing, arranged according to the order of relative importance for most problems:

1. Protection against deformation, breakage, etc.
2. Resistance against moisture, humidity, and temperature.
3. Light weight.
4. Ease of opening.
5. Ease of handling, stacking, and storing.
6. Reclosability.
7. Unit pack.
8. Ease of being packed.
9. Ease of manufacture.
10. Availability.

These requirements, although arranged in general in the relative order of importance, may need to be considered in a different order in the packing designer's mind for special problems. For example, the consideration of light weight has recently been the primary objective in certain packing redesigns. Item 7, unit pack, may be a very important requirement for items to be used by paratroopers, and item 1 must be considered in its broad sense, in that protection against deformation means not only mechanical deformation but possible damage due to detonation of another component in the same box. It also includes protection against sympathetic detonation.

3. Laboratory Tests.

Some of the tests now made in the packing laboratory to check ammunition packing are as follows:

Vibration Test. In the VIBRATION TEST the ammunition is strapped or fastened to a flat vibrating surface for a given period of time, usually 4 hr. The frequency of vibration is 550 cycles per minute, and the entire platform moves according to a $\frac{1}{8}$ -in. eccentric cam motion. Such a test corresponds in a rough way to vibration in the hold of a ship, in a plane, or in a railroad car. Typical vibration apparatus is shown in Fig. 225.

Rotating-Drum Test. The ROTATING-DRUM TEST was the first attempt to provide a controlled rough-handling packing test, and it has long been used for all types of commercial and military packing. In this test a drum 14 ft. in diameter rotates at one revolution per minute. On the inside of the drum are plates or baffles that serve to carry a box or other packing item up a certain distance before the packing falls over the baffle and hits the bottom of the drum inside, landing on its corner or however chance may dictate. There are six falls per revolution of the drum.

The usual test consists of ninety-six such falls, and the drop test and drum test are run in connection with each other. After each series of twenty-four falls in the drum the packing is dropped once as explained in the next paragraph, is then put in a rotating drum for twenty-four additional falls, then dropped again, etc., until a total of ninety-six falls in the drum and four drops are completed. The drum is shown in Fig. 225.

Drop Test. The DROP TEST is a simple one in which the packing is dropped 4 ft. on a steel plate supported by a concrete column. It is usually repeated four times, and if the packing is in the shape of a box, it is dropped so that it impacts on a diagonal and is stressed the worst way. In addition, if containers might be damaged by a fall on the side,

or if their contents would be damaged by such a fall, the containers are dropped so that a side impacts the narrow edge of a 2 by 4 in. piece of soft wood. This test is sometimes run in connection with the rotating-drum test.

Immersion Test. To test the waterproofness of packing, an IMMERSION TEST is performed in which the item is immersed in a tank of water at a depth of 10 ft. for about 30 min. The water is at room temperature. Upon removal the packing is examined for evidences of leakage.



FIG. 225. Packing test equipment.

Surveillance Tests. SURVEILLANCE TESTS of ammunition packing are usually not conducted as such, but surveillance information is obtained from a knowledge of the surveillance properties of the packing materials plus experience in the field on actual ammunition storage over a period of years.

Accelerated surveillance testing may be performed if equipment permits. The temperature range is -65 to $+170^{\circ}$ F., and humidity ranges from 0 to 100%. Equipment for such testing is available at Picatinny Arsenal in Dover, New Jersey.

Conbur Inclined Test. Equipment for conducting the CONBUR TEST consists of an inclined plane with a 4-ft. rise in 23 ft. down which a small cart rolls on wheels and is halted by a permanent stop of wood. The

article to be tested is placed on the cart so that the packing hits the stop, thus simulating movement of packing in box cars, etc. Pallets, crates, and large boxes that do not lend themselves to some of the other tests may be tested in this way.

From a strictly functional viewpoint, any or all of these laboratory tests may be performed to determine the following:

1. Strength of the packing container itself without regard to its protective effect on the ammunition. This statement applies not only to an outside box or crate but also to individual cans or containers inside, any packing stops, space fillers, etc., the object being to ascertain whether the packing itself is strong enough to withstand transportation and handling.

2. Protection of the ammunition. Even though the packing itself might withstand the test, it is essential to examine the ammunition to see whether it is damaged externally or internally even though the packing itself is not damaged; a redesign for this purpose may be required.

3. Sympathetic detonation. The purpose of the test may be to determine whether detonation of one sensitive element causes detonation of others in the same container or in adjacent containers.

4. Wood Boxes.

The wood box is the oldest form of ammunition packing and is still in use. Although replaced to a large extent by metal packing, the wood box is to packing what sugar is to a grocery store. There are many variations of boxes, but the designs are so standardized that they will not be discussed in this treatise. Suffice it to say that the quality of the boxes should be high, in that they should be made of lumber with a minimum number of knots and a moisture content not over that allowed by the specification, and the workmanship should be satisfactory.

5. Palletized Packing.

A PALLET is a platform on which large components are placed and fastened by some suitable means, so that the platform with its contents may be handled as a unit. The movement is usually by means of a lift truck with arms which are inserted under the pallet so that it may be lifted. The pallet has legs or skids to raise it off the floor in order that the lift-truck arms may be inserted under it, as shown in Fig. 226. By this means a quantity of components, all fastened to the pallet, may be stored, moved, shipped, and unloaded at the destination. The

pallets are shipped back to the point of loading, either empty or with return merchandise, or if they are of standard design for universal use between buildings and plants of one organization they can merely be devoted to another purpose.

The various ammunition plants utilize pallets for such items as certain shell, rockets, and large components. For interplant shipment, palletization is possible for sizes of shell as low as 75 mm., but for shipment of loaded shell, pallets are used only for separate-loaded shell. Such shell have the customary eye-bolt lifting plugs and grommets protect them when the pallet is unloaded. Industry and the Navy have employed palletization extensively and successfully for some time.

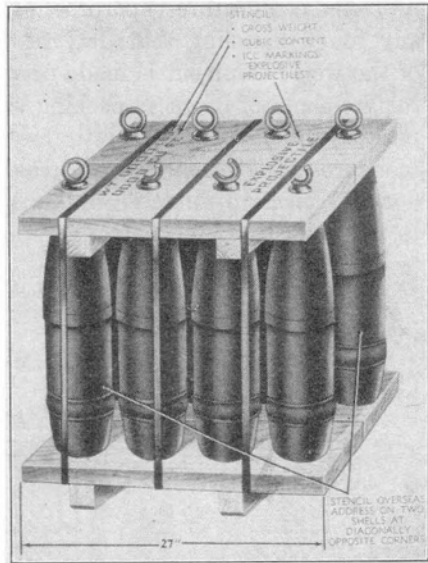

FIG. 226. Palletized separate-loaded shell.

Figure 227 shows a variation of palletized packing, consisting of a wood box with skids under it, so that the unit may be handled as a pallet, even though it is much more than a platform.

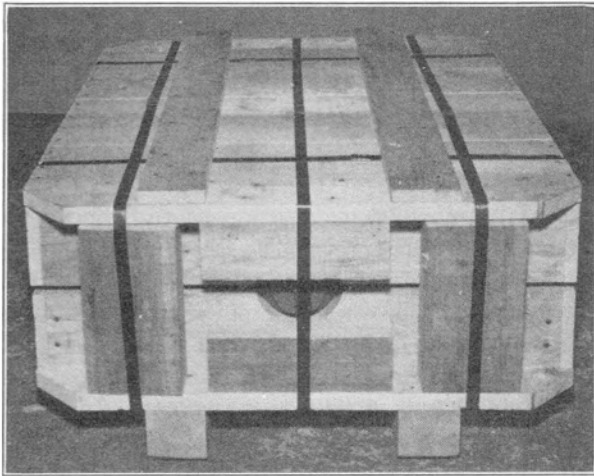

FIG. 227. Pallet-type box with skids.

6. Overseas Packing.

General Description and Requirements. OVERSEAS PACKING involves the problems of moisture-vaporproofing packing and of protection against any rough handling that may be expected, no matter to what part of the world shipment is made or what the conditions of storage. The requirements of overseas packing are much more severe than those for packing intended for domestic use or interplant shipment. Heat and moisture cause packing to deteriorate, and, though not much can be done to insulate ammunition by keeping it cool, much can be done to keep moisture and moisture vapor out.

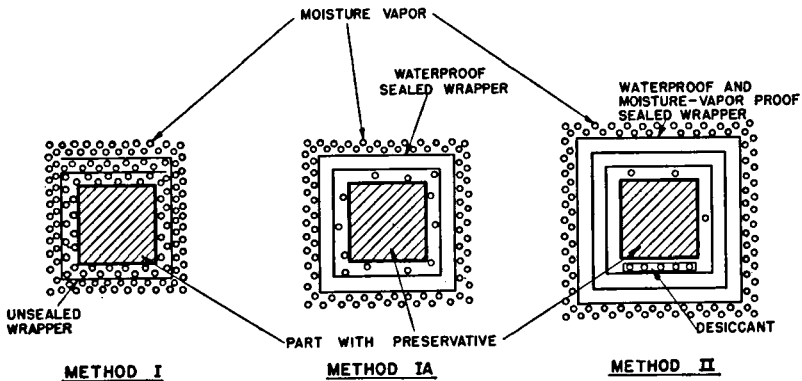

FIG. 228. Illustration of packing methods.

It is important to understand the difference between waterproofing and moisture vaporproofing. A material that is waterproof is not necessarily moisture vaporproof, as very small apertures through which water will not pass may allow moisture vapor to pass, especially when combined with heat. A pack that is really moisture vaporproof is therefore waterproof, and such a pack is a definite requirement for overseas packing on certain items.

The so-called "Method I" pack, consisting of dipping articles in a material impervious to moisture such as oils or waxes and overwrapping with greaseproof paper before packing in suitable boxes, is not applicable to ammunition packing because ammunition components are usually damaged by oils or other fluids getting into crevices and affecting ammunition performance. Instead, the "Method IA" pack is chosen, in which the container itself is treated or hermetically sealed to obtain moistureproofness without the necessity for a desiccant in the container. Variations of the IA pack now current consist of the metal-lined box or container, the sealed can or container, and the moistureproof method of

wrapping. In Method II packing, the wrapper is also both waterproof, and moisture-vaporproof, and a desiccant absorbs most of the residual moisture.

Figure 228 shows the difference between Methods I, IA, and II packing diagrammatically.

Sealed Containers. Metal cartridge storage cases for propellant powder, metal containers of the commercial can variety, sealed with an automatic crimping machine or soldered, and steel containers for artillery complete rounds, are all examples of moistureproof, Method IA, overseas-type packing. Metal cartridge storage cases and metal containers for complete rounds must be hermetically sealed either by actual fusion of metal or by a suitable closure. Containers of the commercial can type are sealed automatically, or soldered if automatic crimping machines are not available, and are opened by a tear strip. Such cans have been used for 75-mm. artillery rounds and 4.5-in. rockets. Fuzes are shipped in smaller commercial-type sealed cans. Figure 229 shows a metal cartridge storage case with closure, and Fig. 237 shows a metal container for a semifixed complete round, with closure.

Method IA Wrap Packing. Ammunition components that cannot be shipped in sealed cans may be prepared for overseas shipment by packing them in cartons or boxes which are not themselves moistureproof, then wrapping these containers with waterproof impregnated fabric, then wax dipping to complete moistureproofness. The containers are wrapped with Kraft paper to prevent sticking of one to another and then placed in an outside container such as a wood box. This provides an excellent overseas pack, or a good domestic interplant pack where moistureproofness is required, as for powder train rings, etc.; it is shown in Fig. 230.

Method II Packing. This is the same as Method IA except that a desiccant such as silica gel is placed inside the container to absorb

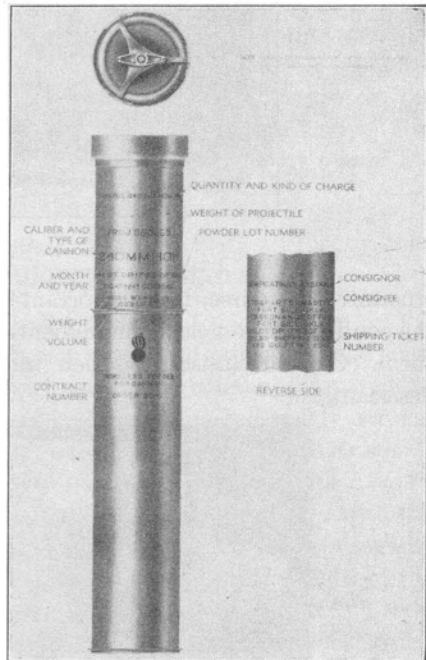

FIG. 229. Cartridge storage case for separate-loaded propelling charge.

moisture from the entrapped air. When the relative humidity is less than 20%, corrosion is absent or kept to an inappreciable and ineffective

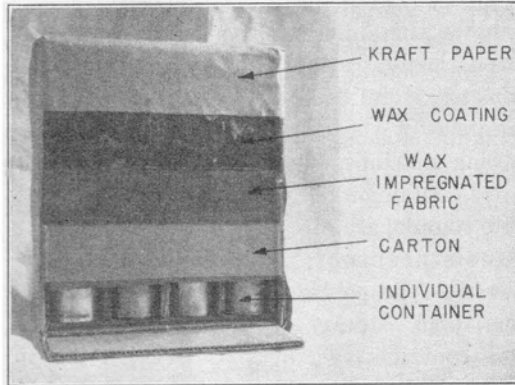

FIG. 230. Method 1A packing.

amount. Of course, it is important that silica gel be omitted if any of the contents have volatile ingredients the removal of which would injure them. Certain plastics lose their valuable properties when packed with desiccants.

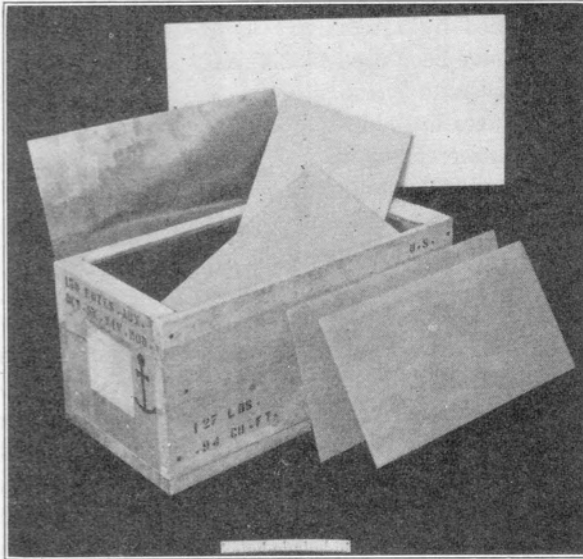

FIG. 231. Metal-lined packing box.

Metal Liners for Boxes. A metal-lined box, Fig. 231, for protecting ammunition from moisture is effective when properly supported to prevent

damage from rough handling but is somewhat tedious to manufacture. Joints and seams have to be welded or soldered, and the top usually requires soldering by hand, after all the contents are in place. Liners are made from terneplate of about 28 gage and must be tested by air pressure for leaks. Even these liners do deteriorate under the worst conditions, but their use is wide at the present time, especially for ammunition not lending itself to a cylindrical type of packing container.

Overseas Shipments without Special Packing. Some ammunition components, especially those that contain no explosives, are protected by plating or painting so that no special packing is required. A separate-loaded artillery shell is sent overseas with a grommet to protect the rotating band in exactly the same way it is shipped domestically. But most ammunition items for overseas are specially packed by one of the methods mentioned above.

ARTILLERY-AMMUNITION PACKING

7. General.

Packing of artillery ammunition has undergone a radical change since 1942. Whereas bombs present few packing problems compared to artillery ammunition, because they are large units inherently strong, are shipped unfuzed (except for small fragmentation bombs and clusters), and have no propellant powder to be protected, artillery rounds may be shipped fuzed and in any event powder must be shipped either with the rounds or separately. Another point of difference is that the total weight of a bomb is usually over 100 lb. and that determines the weight of the packed article, whereas many artillery rounds weigh under 100 lb. and the weight of the packed article is left to the packing engineer. During the early part of World War II, artillery packing was generally unsatisfactory because it was heavy and bulky, and insufficient protection was afforded the round from the elements of nature and the rough handling it was required to withstand. Our first overseas shipments were to North Africa and the Pacific, and information was obtained very quickly that the conventional "cloverleaf bundle" was not satisfactory. This bundle, Fig. 232, consisted of three complete rounds or three propelling charges in individual fiber containers, held together by sheet-metal cloverleaf ends by means of axial rods bolted at the ends. Crating of these bundles increased the weight but did give more protection to the ammunition. The fiber container, Fig. 233, is of the slip-cover mailing-tube type with metal ends. Propelling charges were also formerly shipped in cloverleaf packing, with unsatisfactory results.

The packing of four rounds, each in its individual fiber container, in

a wood box was next tried, and 57-, 75-, 76-, and 105-mm. and also 3-in. complete rounds were so packed, the boxes having rope handles.

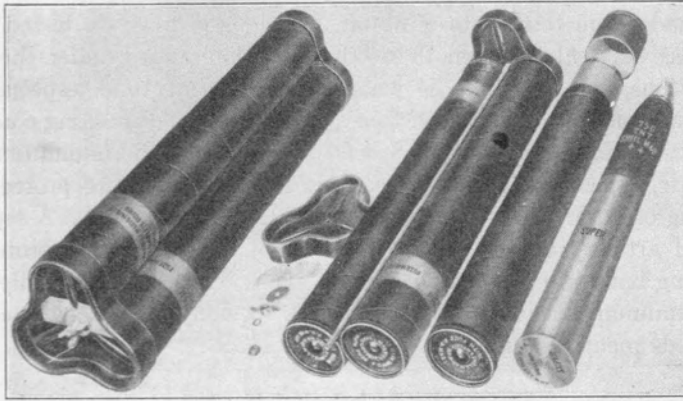

FIG. 232. Cloverleaf packing for complete rounds.

Although this packing constituted a distinct improvement, the disadvantages of high weight and insufficient protection were still present.

When the general requirement that any box of any kind of ammunition should be limited in weight to 50 lb. (provided that the actual packed item did not weigh more) was instituted, the four-round box was cut to

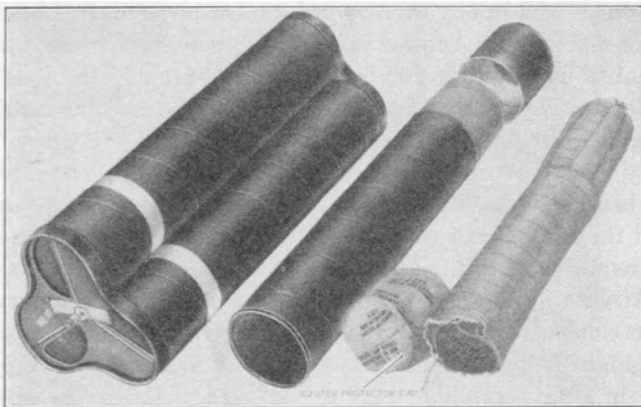

FIG. 233. Cloverleaf packing for propelling charges.

a two-round box, and such packing is used today. Metal liners may be needed for overseas shipments.

Boxes were stained dark brown until 1943 when it was decided that such staining for camouflaging purposes was no longer required.

8. Metal-Container Program.

It was long recognized that desirable packing for an artillery round would consist of a sealed steel tube or cylindrical container that would completely protect the round from impact of any kind and from moisture



FIG. 234. Metal-container packing for fixed artillery round.

and moisture vapor. Such packing is heavy, expensive, and difficult to manufacture, requiring large presses and other fabricating equipment. It is the answer to the problem, nevertheless, and is used for packing 60-, 81-, 57-, 75-, 90-, and 105-mm. and 3-in. complete rounds, except that the 60- and 81-mm. rounds are packed in fiber containers and several rounds are put in a steel container, depending on the weight of the individual round. Semifixed howitzer rounds are also packed in fiber containers inside the steel container.

Figure 234 shows a typical complete-round container. It consists of a cylindrical body made from hot-rolled steel tubing, a detachable cap, having bayonet-type connection, with appropriate rubber, felt, and

cork pads to absorb shock and insure compactness and tightness, and a bolt assembly with cap to exert pressure on the sealing cover. These containers are marked with the usual marking.

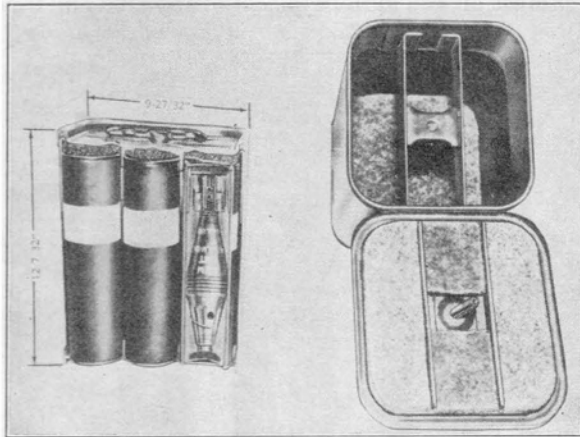

FIG. 235. Metal-can packing for 60-mm. mortar rounds.

The 75-mm. T7 metal container is typical. It is about 32 in. long, $4\frac{3}{4}$ in. in diameter, and weighs $11\frac{1}{2}$ lb. empty. The cap has a rubber gasket, one cork pad, two felt pads, and two metal guides, as well as

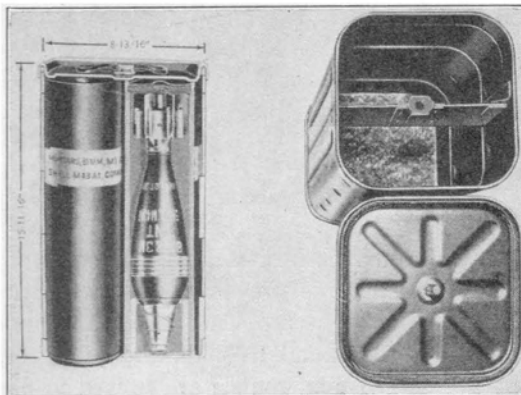

FIG. 236. Metal-can packing for 81-mm. mortar rounds.

other spacers to position the round. It weighs $31\frac{1}{4}$ lb. loaded as compared to $23\frac{1}{2}$ lb. for the same round in a fiber container.

Mortar ammunition is packed in metal boxes, Figs. 235 and 236. The 60-mm. rounds are no longer packed in cloverleaf bundle packing,

but eight M49A2 rounds, each in an individual fiber container, are packed in a metal box 11.8 in. high and 9.8 in. square, having felt pads for cushioning and a metal handle. The 81-mm. rounds are packed similarly except that four M43A1 rounds are packed in a metal box. The M56 81-mm. round is packed in an individual container.

Individual metal containers are used to pack 57-, 75-, 76-, 90-, and 105-mm. and 3-in. complete rounds; 75- and 105-mm. howitzer rounds are packed in individual fiber containers inside individual metal containers; see Fig. 237.

The metal-container program is a new development, and alternative materials such as aluminum may be used to reduce weight.

9. Fixed and Semifixed Round Packing.

Formerly, 20-mm. rounds were packed ten cartridges in a chip-board carton and twelve cartons in a metal-lined wood box weighing about 95 lb. Individual cartridges are now placed in sleeves and are then packed twenty-five in a hermetically sealed integral tear-strip metal container. Six of these containers are packed in a wooden box.

Thirty-seven-millimeter rounds are packed in fiber containers, twenty to forty of them in a wood box, but in the future eight to ten rounds per box will be packed to keep the weight down to 50 lb.

Forty-millimeter rounds are packed either (a) one round per fiber container and six containers per box, weighing about 50 lb., (b) four rounds per charge clip, and six clips in a metal box, weighing about 150 lb., (c) one round per fiber container and twenty-four containers per box, weighing about 160 lb., or (d) one round per fiber container and twelve containers per box, weighing about 90 lb.

The 57-, 75-, 76-, 90-, and 105-mm. and 3-in. rounds are packed two rounds per box in individual fiber containers, as well as in metal containers, until the metal-container program can supersede box type of packing. The change from four or six rounds to two rounds per box cuts down weight.



FIG. 237. Metal-container packing for semifixed artillery round.

10. Separate-Loaded-Ammunition Packing.

Separate-loaded artillery ammunition is packed by breaking the round into three parts, because of the way such ammunition is handled and fired in the field. Projectiles, except those with windshields and caps, are shipped with an eye-bolt lifting plug in the nose and a grommet. The EYE-BOLT LIFTING PLUG is screwed into the fuze cavity, and it serves three purposes: it keeps foreign matter out of the cavity; it protects the threads; and it provides a ready means for lifting the projectile, thus facilitating handling. The GROMMET is a device for protecting the

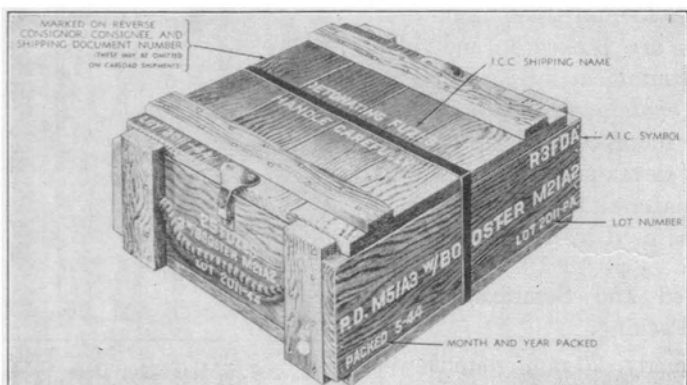

FIG. 238. Typical packing for fuzes.

soft rotating band during handling and shipment, because damage to the band may result in improper seating, lack of obturation, and inaccurate ballistics. Originally of rope, formed by splicing and held with hemp twine, grommets are now made of sheet metal having a fiber liner and held in place by a clamp or wire.

The propelling charges are packed separately in metal containers called CARTRIDGE STORAGE CASES. They are hermetically sealed to protect the powder from moisture. Fiber containers were formerly used in place of metal cases; they are sometimes packed three in a cloverleaf bundle, and the bundle is crated. Primers for separate-loaded ammunition are packed fifty in a metal container and forty-eight containers to a wood box. Fuzes are packed in individual fiber containers or preferably metal cans, twenty-five to fifty per box. Examples of packing for these components are shown in Figs. 229 and 238.

AP projectiles with windshields are packed in crates to protect the band, windshield, and cap. Propelling charges for large-caliber AP shell, such as the 14-in., are packed half a charge to a case.

AIRCRAFT-AMMUNITION PACKING

11. General.

Bombs are packed in three general ways, according to whether they weigh about 100 lb., or more, or less. All bombs except small fragmentation bombs are shipped unfuzed, with metal CLOSING PLUGS to protect the cavities from foreign matter and to protect the threads. Clustered bombs require additional packing, depending upon the nature of the cluster adapter, whether the fuzes are shipped attached to the cluster, the shape of the cluster, etc.

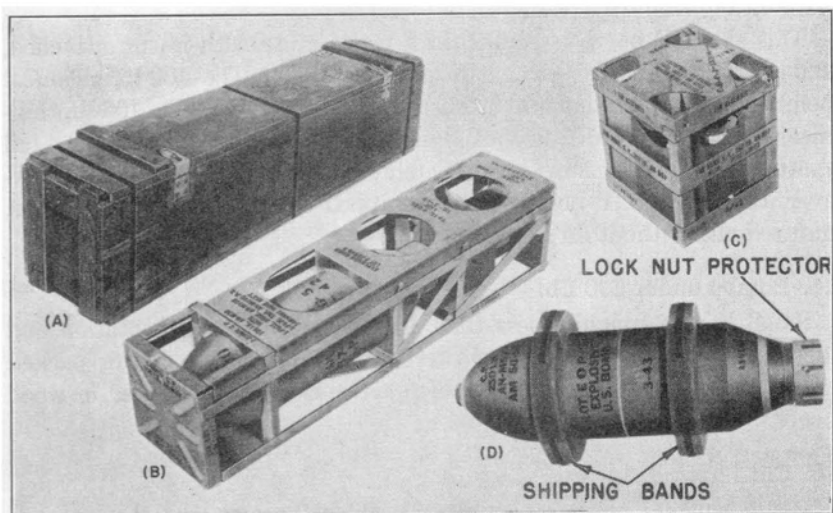

FIG. 239. Types of bomb packing.

12. Bombs over 100 Lb.

Figure 239D shows the method of packing bombs weighing more than 100 lb. There are three assemblies to the packing, the bomb itself, the fin assembly, and the fuzes. The bombs are shipped with SHIPPING PLUGS to protect the fuze cavities, two SHIPPING BANDS to protect the suspension lugs and allow the bomb to be handled by rolling on a hard surface, and a FIN LOCK NUT PROTECTOR to protect the fin lock nut and the tail end of the bomb. The shipping plugs close the fuze cavities, protect the threads, and keep foreign material out of the fuze well. The shipping bands, formerly made of steel, are now made of layers of paper pressed and glued together, and are channeled to fit over the lugs. They are held on the bomb by a thin metal strap. Fin lock nut

protectors are made of steel or composition material and are held in place by the lock nut itself.

Fin assemblies are shipped separately in their own metal shipping crates, Fig. 239C. Metal is used primarily because wood packing is undesirable aboard ship and also for protection because the fin assemblies are easily damaged or bent out of shape. Bomb fuzes are packed like artillery fuzes, namely, in individual cans, preferably sealed metal cans, and then in a wood box. Arming wire assemblies may be packed in bulk in wood boxes. HOISTING BANDS fit around the bomb and are for handling only.

13. 100-Lb. Bombs.

This size GP bomb is packed in a metal crate with its fin attached, and with nose and tail closing plugs, Fig. 239B. The 100-lb. chemical bomb is packed without fuze or burster in a wood box. The 100-lb. thin-case practice bomb M38 is packed in a fiberboard container, and the tail spotting charges are shipped separately, packed twenty per box. However, the 100-lb. GP bomb may be shipped the same as larger bombs, unfuzed and without fin assembly.

14. Bombs under 100 Lb.

Small bombs weighing less than 100 lb., such as fragmentation and incendiary bombs, are either clustered and properly packed or packed individually in a wood box. Small practice bombs are packed in wood boxes.

15. Clusters.

Bomb clusters present a packing problem because the cluster, consisting of many smaller parts including possibly fuzes, fins, and arming wires, and weighing several hundred pounds, cannot be treated like a

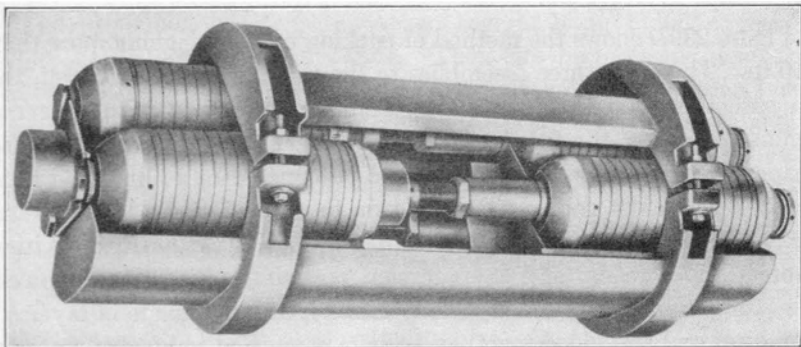

FIG. 240. Cluster with shipping bands.

single large bomb of the same weight without fuze, fin, or arming wire. Whereas a 500-lb. bomb is shipped unfuzed without fins and with no



FIG. 241. Wood-supported cluster in steel drum.

packing except two shipping bands, a cluster of smaller bombs that replaces the one bomb cannot be so packed.

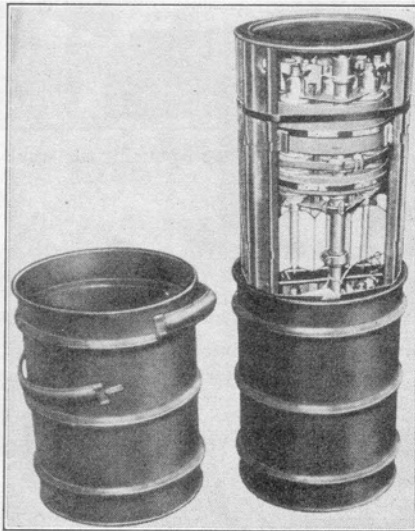

FIG. 242. Metal-supported cluster in steel drum.

Figure 240 shows the cluster of six 90-lb. fragmentation bombs weighing 608 lb., and packed in two metal shipping bands supported by

horizontal members. Another way of packing a cluster, such as the cluster of twenty 20-lb. fragmentation bombs, consists of a cradle (like a crate), either wood as in Fig. 241 or metal as in Fig. 242, the assembly being packed in a steel drum in two sections held together by a band sealed with a gasket. Clusters may also be packed in metal-lined wood boxes.



FIG. 243. Combination metal and wood packing for small-arms ammunition.

16. Small-Arms Packing.

Small-arms ammunition is packed in standard wood boxes with a cover held down by four or six wing nuts with a metal liner, or in cartons placed in sealed metal cans, which are in turn packed in wood boxes, Figs. 243 and 244. A paraffin-coated cardboard liner has served as a substitute for the metal liner, and packing envelopes have also been used.

For a machine-gun belt of 250 rounds, a metal box is used and four boxes are crated together.

17. Miscellaneous Ammunition Packing.

Miscellaneous ammunition—grenades, firing devices, antipersonnel mines, rifle grenades, antitank mines, etc.—are packed in wood boxes, although metal boxes and crates are being developed. Some rocket

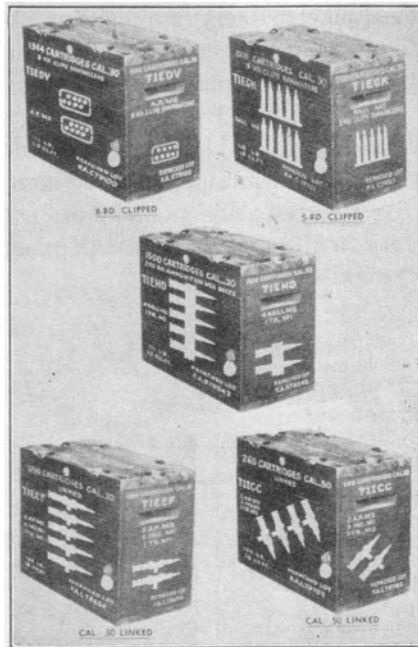

FIG. 244. Packing and marking of small-arms ammunition.

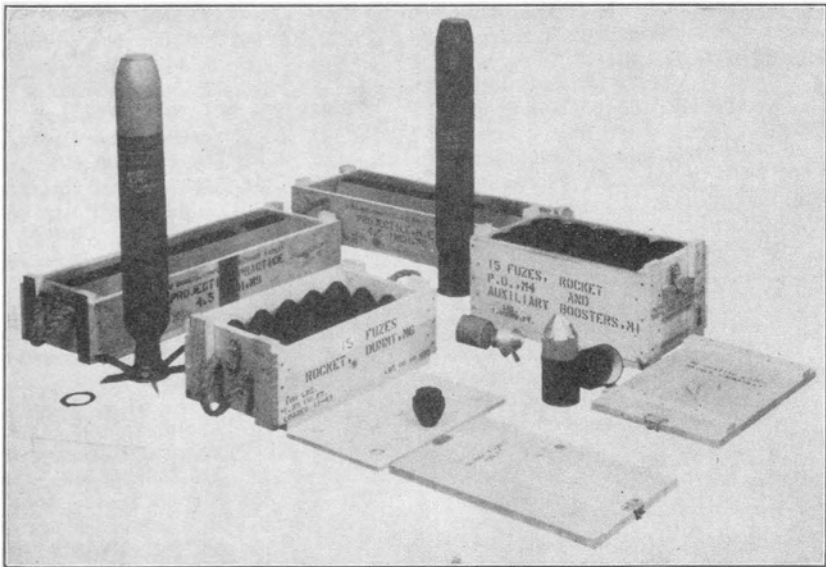

FIG. 245. Typical rocket packing.

ammunition is packed like artillery ammunition, but some requires special packing. Figure 245 shows conventional rocket packing. Some 4.5-in. rockets are packed in their plastic launchers, Fig. 201, which are in turn packed in a wood box. Pyrotechnics are usually packed in individual fiber containers and wood boxes. For example, hand grenades are packed in individual fiber containers, twenty-five to the box; firing devices are packed five to a box; rifle grenades are packed in individual fiber containers, twenty to fifty per box; antitank mines are packed about five per box with plywood separators, etc.

INDEX

- Aberdeen Proving Ground, 210, 326
 Acceleration, of artillery, 88, 124, 131
 of rocket, 335
 Accuracy, of rocket, 331, 347, 352
 of small arms, 70
 Activator, mine, 363
 Adamsite, 105
 Adapter, cluster, 241
 grenade projection, 360
 Adapter booster, 217, 225, 249, 263, 273
 Agent, binding, 294
 chemical, 101
 incendiary, 104
 non-persistent, 104
 persistent, 104
 waterproofing, 294, 384, 385
 Aimable cluster, 241, 270, 283
 Air burst, 155, 160, 162, 256, 262
 Air pressure, 258, 262
 Air resistance, 91, 130
 Air travel distance, 252
 Aircraft, 66, 126, 145, 190, 195, 197, 280,
 313, 344, 350
 altitude of, 190, 198, 200, 205, 229, 252
 drift of, 313, 314
 identification of, 309, 316
 speed of, 73, 197, 199, 252, 253
 Aircraft ammunition, 7, 66, 151, 173,
 195, 308, 323, 393
 Aircraft flare, 269, 315, 317
 Aircraft pyrotechnics, 8, 195, 292, 308,
 315
 Aircraft rocket, 331, 343, 346, 350
 Aircraft torpedo, 195
 Airport flare, 304
 Aliquot part charge, 184, 189
 Always fuze, 239
 Altitude, release, 199
 Amatol, 34, 38
 Ammonium picrate, 37
 Ammunition, aircraft, 7, 66, 151, 173,
 195, 308, 323, 393
 antiaircraft, 66, 150, 155, 173, 190
 armor-piercing, 7, 8, 9, 60, 65, 86, 107,
 138, 220, 232, 288, 332
 artillery, 7, 86, 195, 387
 blank, 7, 65, 80, 115, 173
 British, 61, 120, 145, 147,
 195, 227
 canister, 7, 8, 86
 chemical, 7, 8, 9, 86, 101, 105, 120, 220,
 234, 238, 268, 290, 332, 339, 355, 359
 classification of, 6
 definition of, 1
 drill, 7, 8, 9, 114, 172, 221
 experimental, 11, 111
 fixed, 7, 8, 171, 175, 391
 French, 10, 195, 222
 gallery practice, 65
 general types of, 7
 high-explosive, 7, 8, 332
 illuminating, 7, 8, 86, 117, 163, 301, 359
 incendiary, 8, 65, 71, 75, 234, 355, 359
 limited standard, 13
 lot numbers of, 13
 miscellaneous, 9, 10, 354
 mortar, 55, 117, 118
 Navy, 61, 117, 149, 215, 231, 232, 271,
 274, 280, 326, 344, 383
 nomenclature of, 10, 65, 174, 215, 249
 packing of, 377, 387
 practice, 7, 9, 113, 147, 172, 220, 332
 pyrotechnic, 7, 8, 291
 rifle grenade, 6, 66, 354, 357, 360
 rocket, 9, 326
 semi-armor-piercing, 220
 semifixed, 7, 171, 180, 391
 separate-loaded, 7, 114, 172, 184, 392
 service, 7, 9, 332
 small-arms, 6, 64, 195, 396
 smoke, 7, 8, 9, 120, 220, 234
 standard, 13
 subcaliber, 6, 66, 176, 178, 179
 substitute standard, 13
 Ampoule, 14, 280, 366
 Anchor, land, 121
 Anemometer vane, 230, 239, 285
 Angle, of fire, 6
 glide, 202
 impact, 199
 range, 198
 trail, 198
 Antiaircraft ammunition, 66, 150, 155,
 173, 190

- Antiaircraft practice, 316
 Antiaircraft rocket, 343
 Antidisturbance fuze, 267
 Antipersonnel artillery, 156, 160
 Antipersonnel bomb, 235
 Antipersonnel mine, 9, 354, 363, 367, 369
 Antitank grenade, 361
 Antitank gun, 3, 139, 173, 178
 Antitank mine, 3, 9, 354, 363
 Antiwithdrawal, 281, 283
 AP ammunition, 7, 8, 9, 60, 65, 86, 107, 138, 220, 232, 288, 332, 347
 AP projectile, 60, 86, 108, 109, 138
 AP shot, 108
 Area bombing, 241
 Arming, booster, 166
 delayed, 149, 256, 267
 direct, 256
 fuze, 127, 135, 140, 251
 hydrostatic, 256
 Arming head, 278
 Arming pawl, 218, 256
 Arming pin, 250, 251, 256
 Arming stem, 260, 273
 Arming test, 135
 Arming time, 251
 Arming vane, 250, 251, 256
 Arming wire, 216, 217, 251
 Armor-piercing ammunition, *see* AP ammunition
 Artillery, antiaircraft, 173
 antipersonnel, 156, 160
 mobile, 173
 railway, 173
 seacoast, 173
 Artillery ammunition, 7, 86, 195, 387
 Artillery booster, 105, 122, 123, 128, 165
 Artillery fuze, 122
 Artillery primer, 12, 27, 45, 51, 171
 Artillery projectile, 86
 Artillery round, 171
 Artillery shell, 86, 91
 Auxiliary booster, 20, 217, 249, 338

 Bag, green, 185
 powder, 180, 184, 334
 white, 185
 Ball ammunition, 65
 Ballistic efficiency, 87
 Ballistic interchangeability, 124, 144
 Ballistic mortar, 33
 Ballistic pendulum, 33
 Ballistics, artillery, 87
 bomb, 197
 exterior, 88
 interior, 87

 Ballistics, small-arms, 71
 terminal, 88
 Ballistics Research Laboratory, 73, 88, 95
 Ballistite, 28
 Band, hoisting, 394
 rotating, 93, 98
 shipping, 393
 suspension, 216
 trunnion, 216
 Bangalore torpedo, 120, 375
 Barometric fuze, 258
 Base charge, 181, 184, 192
 Base cover, 98
 Base detonating fuze, 125, 138
 Base ejection shell, 107
 Base ignition shell, 107
 Base plate, 217
 Bazooka, 329, 335, 342
 Beach defense mine, 9, 363
 Bellows, 282, 286
 Bickford fuse, 29, 236, 275, 372
 Binding agent, 294
 Black powder, 28, 115, 138, 147, 193, 262, 270, 340, 357
 Blank ammunition, 7, 65, 80, 115, 173
 Blast of bomb, 203, 204, 213, 221, 227, 231
 Blast pressure, 203
 Blasting cap, 59, 60
 Blending of powder, 28
 Blister gas, 104
 Blockbuster, 203, 227
 Boattail, artillery, 92, 98, 109, 141
 small-arms, 73, 75
 Body, of bomb, 212, 216, 217
 of shell, 98
 of shot, 111
 Bomb, 7, 195
 air burst of, 257
 armor-piercing, 8, 220, 232, 288
 blast of, 203, 204, 213, 221, 227, 231
 butterfly, 231, 267
 capacity of, 220, 222, 232
 center of form of, 208
 center of gravity of, 208
 chemical, 8, 220, 234, 238, 268, 290
 demolition, 8, 222
 depth, 8, 220, 231, 271, 290
 double-fuzing, 224
 drill, 8, 221
 explosive train of, 218, 249
 fire, 234
 fragmentation, 8, 213, 220, 227, 229, 264, 289
 general-purpose, 8, 220, 222, 258, 288
 glide, 202, 373

- Bomb, helix, 230
 high-capacity, 221
 incendiary, 8, 234, 236
 light-case, 8, 220, 237, 289
 low-capacity, 221
 marking of, 220
 nose design of, 206
 packing of, 393, 394
 parachute, 198, 216, 226, 228, 230, 240, 265, 285
 photoflash, 269, 318, 320
 practice, 8, 220, 239, 268
 semi-armor-piercing, 8, 220, 232, 289
 service, 8, 221
 shaped-charge, 240
 smoke, 8, 220, 234, 237, 268
 stress in, 209, 214
 target-identification, 271
 volume of, 211
 weight of, 211, 220
 welding of, 214, 223
 Bomb ballistics, 197
 Bomb classification, 7, 220, 221
 Bomb cluster, 196, 241, 268
 Bomb complete round, 7, 216
 Bomb crater, 214
 Bomb design, 204, 212
 Bomb detonation, 202
 Bomb fin, 207, 216
 Bomb fuze, 216, 248
 Bomb rack, 218, 241
 Bomb shackle, 218
 Bomb station, 241
 Bomb target, 223, 227, 229, 232, 235
 Bombardment flare, 315
 Bombing, area, 241
 dive, 201
 glide, 202
 high-altitude, 200
 hedge-hopping, 201
 low-altitude, 201, 228, 265, 274
 medium-altitude, 201
 minimum-altitude, 201
 point, 241
 radio-controlled, 202
 skip, 201, 227, 252, 274, 279
 types of, 200
 Booby trap, 281, 354, 363, 367
 Booster, 19, 22, 36
 adapter, 217, 225, 249, 263, 273
 arming, 166
 artillery, 105, 122, 123, 128, 165
 auxiliary, 20, 217, 249, 338
 black-powder, 262, 270
 bomb, 249
 concrete-piercing, 169
 Booster, definition of, 122
 integral, 165
 separate, 165
 Bore safety, 123
 Bouncing Betty flare, 303
 Bouncing Betty mine, 363, 367
 Bourrelet, 98, 118
 Box, metal, 390
 metal-lined, 386
 packing, 378, 380, 382, 388, 390, 396
 wood, 382, 388, 394, 398
 Brisance, 19, 33
 British ammunition, 61, 120, 145, 147, 195, 227
 Brombenzylcyanide, 104
 Bullet, cannellure of, 73
 core of, 73
 design of, 73
 filler of, 73
 headlite, 78
 incendiary, 75
 jacket of, 73
 small-arms, 6
 tracer, 77
 Bullet pull, 68, 70
 Bureau of Mines, 31
 Burning, 17, 21
 digressive, 22
 neutral, 23
 progressive, 23
 rate of, 17, 21, 29, 60, 77, 155, 294, 302, 307, 323, 328, 330
 Burster, 36, 105, 234, 334
 Bursting charge, 19, 36, 123, 218
 Butterfly bomb, 231, 267

 Cadmium plating, 14
 Caliber, artillery, 10
 small-arms, 64
 Candle, pyrotechnic, 293, 296
 Candlepower, of projectile, 117
 of pyrotechnic, 294, 299, 303, 305, 315, 318
 Canister, 7, 8, 86
 Cannellure, 73
 Cannon, 3
 Cap, blasting, 59, 60
 Cap shot, 108, 112
 Carbine ammunition, 64
 Carborundum, 46
 Cartridge, 6, 65, 78
 AP, 65, 66
 ball, 65, 66, 78, 80
 blank, 78, 80
 cluster-release, 241, 245
 ignition, 55, 192

- Cartridge, incendiary, 99
 - marking of, 78
 - photoflash, 320
 - rifle-grenade, 81
 - shot, 84
 - signal, 312
 - tracer, 99
 - Cartridge case, 78, 79, 171, 175
 - Cartridge storage case, 385, 392
 - Casualty agent, 104
 - Casualty test, 71
 - Case, cartridge, 78, 79, 171, 175
 - Cavitation, 211
 - Cavity effect, 42
 - Center of form, 208
 - Centrifugal force, 129
 - Chamber pressure, *see* Pressure
 - Charge, aliquot part, 184, 189
 - base, 181, 184, 192
 - bursting, 19, 36, 123, 218
 - ejector, 236
 - increment, 181, 184, 192
 - normal, 188
 - spotting, 239
 - stacked, 184, 189
 - Chemical agent, 101
 - Chemical ammunition, 7, 8, 9, 86, 101, 105, 120, 220, 234, 238, 268, 290, 339, 355, 359
 - Chemical mortar, 164, 191
 - Chemical Warfare Service, 101
 - Chloracetophenone, 104
 - Chlorine, 104
 - Chlorpicrin, 104
 - Choking gas, 104
 - Chronograph, 138
 - Chuffing, 329
 - Clover-leaf packing, 387
 - Cluster, aimable, 241, 270, 283
 - bomb, 196, 241, 268
 - construction of, 243
 - hook and cable, 246
 - packing of, 394
 - release of, 241, 245
 - star, 299
 - strap, 246
 - Cluster adapter, 241
 - Cluster data, 247
 - Coating, 14, 40
 - Cocked firing pin, 250, 274, 279, 364
 - Color, flame, 294
 - Color intensifier, 294, 295
 - Color value, 292, 297
 - Colored smoke, 183, 300, 359, 362
 - Commercial black powder, 29
 - Commercial blasting cap, 59
 - Commercial detonator, 59
 - Commercial primer, 46
 - Compatibility, 89
 - Complete round, artillery, 171, 173
 - bomb, 216
 - mortar, 191
 - requirements of, 174
 - small-arms, 78
 - Composition, of photoflash powder, 318
 - of pyrotechnic, 293
 - of tracer, 61, 62, 77
 - Composition B, *see* RDX
 - Conbur inclined test, 381
 - Concrete piercing, 154, 169, 232
 - Container, fiber, 387, 392, 398
 - metal, 385, 389
 - packing, 385, 387, 398
 - Cooling agent, powder, 25
 - Cord powder, 24
 - Cordite, 28
 - Core of bullet, 73
 - Corrosion, 13, 40
 - Cradle, packing, 396
 - Crater, 214
 - Creep, 124, 129, 140, 278
 - Cricket, 364
 - Critical height for fulminate, 56
 - Cronak, dipping, 14
 - Cup, crusher, 152
 - detonator, 40, 56
 - Cyanogen chloride, 104
 - Cyclonite, 37
 - Cyclotol, 38, 107
-
- D, explosive, 37, 232
 - DBX, explosive, 34, 38
 - DDT, 321
 - Deflagration, 17
 - Delay composition, 277
 - Delay element, 20, 47, 123, 138, 152, 161, 267, 282
 - Demolition block, 367, 373, 376
 - Demolition bomb, 8, 222
 - Demolition mine, 369
 - Density, loading, 80, 176, 210
 - Depth bomb, 8, 220, 231, 271, 290
 - Desiccant, 384
 - Destructor, 9, 354, 370
 - Detonation, 17, 202
 - rate of, 17, 33
 - sympathetic, 382
 - Detonator, 19, 45, 55, 123, 275
 - chemical, 56, 365
 - commercial, 59
 - crushing-action of, 57, 123
 - flash action, 123

- Detonator, lead-plate test of, 57
 properties of, 57
 run-down test of, 58
 sand test of, 134
 sensitivity test of, 58
 shaped-charge, 336
 three-part, 55
 two-part, 55
 waterproofness test of, 58
 Detonator booster, 166
 Detonator charge, 56, 57
 Detonator cup, 40, 56
 Detonator safety, 122, 146, 252, 262
 test of, 134
 Device, demolition, 375
 firing, 367, 369
 Dibutylphthalate, 26
 Die casting, 126, 147, 149, 163, 166
 Dinitrotoluene, 26, 80
 Diphenylamine, 25, 329
 Diphenylchlorarsine, 105
 Diphosgene, 104
 Dipping, 14
 Distress signal, 320
 Dive bombing, 201
 Double-base powder, 27, 193, 328
 Drift signal, 313
 Drill bomb, 8, 221
 Drill projectile, 114, 172
 Drop safety of bomb, 210, 280
 Drop test, 48, 96, 132, 210, 380
 Drop tower, 133, 134
 Drum, packing, 396
 Dummy ammunition, 65, 82, 114, 355

 EC blank powder, 30, 354, 358
 Edna, 37
 Ednatol, 34, 37, 38
 Efficiency, 87, 330
 Electric primer, 51, 53
 Energy content of powder, 25, 27, 328
 Engraving, 93, 98
 Ethyl centralite, 329
 Ethyldichlorarsine, 104
 Expelling charge, 107
 Experimental explosive, 111
 Experimental number, 11
 Explosive, aluminized, 38
 application of, 35
 binary, 34
 bomb, 207
 booster, 36
 brisanse of, 33
 bursting, 36
 cast, 38
 classification of, 34
 compatibility of, 39
 definition of, 16
 experimental, 111
 high, 17, 30, 34
 initiator of, 34
 insensitive, 109
 low, 17, 28
 nitrostarch, 30, 358
 pelleted, 38
 plastic, 37
 pressed, 38
 primary, 34
 properties of, 30
 secondary, 34
 sensitivity of, 30, 111
 stability of, 31
 ternary, 34
 Explosive D, 37, 232
 Explosive train, 19, 45, 122, 135, 218,
 249, 276
 Extension, fuze, 257
 Exterior ballistics, 88
 Eye-bolt lifting plug, 172, 392

 Face-hardened plate, 108, 112
 Factor, stability, 73, 94, 95, 208
 False-ogive projectile, 145, 169
 Fiber container, 387, 392, 398
 Filler, bullet, 73
 Fin, bomb, 207, 216
 mortar, 192
 Fin lock-nut, 216, 393
 Fin sleeve, 216
 Fin-stabilized rocket, 9, 331, 345
 Fire bomb, 234
 Firing device, 367, 369
 First-fire composition, 297
 Fixed ammunition, 7, 8, 171, 175, 391
 Flake powder, 27
 Flame color, 294
 Flare, 8
 aircraft, 269, 315, 317
 airport, 304
 bombardment, 315
 colored towed, 316
 fusee, 306
 hand, 308
 landing, 317
 reconnaissance, 317
 tow-target, 316
 tree, 308
 trip, 303
 Flash, muzzle, 25, 27, 188
 Flash reducer, 184
 FNH and NH powder, 25
 Formulas, artillery-design, 89

- Formulas, bomb-design, 204, 212
 fuze-design, 128
 Fragment velocity, 214
 Fragmentation, 33, 87, 96, 98, 119, 213,
 334, 343, 355
 French ammunition, 10, 195, 222
 Friction pendulum, 31
 Friction primer, 51, 54
 Friction sensitivity, 31
 Fuming smoke, 105
 Fuse, 12
 Bickford, 29, 236, 275, 372
 lead-spitter, 30
 miner's, 29
 safety, 29
 Fusee, 306
 Fuze, 12
 air-burst, 256, 262
 air-pressure, 258, 262
 allways, 239
 antiaircraft, 126, 145, 146, 155, 157
 antidisturbance, 267
 antiwithdrawal, 281, 283
 artillery, 122
 barometric, 258
 base-detonating, 125, 138
 bomb, 216, 248
 bullet impact, 374
 chemical, 366
 classification of, 125, 254
 combination, 125, 127, 156, 160, 162
 concrete-piercing, 154
 definition of, 122
 delay, 109, 161, 255, 357
 depth, 250, 286
 extension, 257
 formulas for, 128
 grenade, 356
 hydrostatic, 231, 250, 256, 286
 impact, 125, 151
 instantaneous, 254
 interchangeability of, 124, 144
 interrupter of, 151
 lock nut of, 283
 magazine charge of, 156
 mortar, 126, 160, 162
 materials of, 126
 mechanical time, 155, 283
 Mod, 145, 169, 170
 non-delay, 125, 255
 nose bomb, 216, 254, 256
 point-detonating, 125, 143, 150, 160
 powder, 29, 357
 powder-train, 155, 163, 357
 requirements of, 124
 rifle-grenade, 357
 Fuze, rocket, 165, 333, 337
 safety, 124, 128, 146
 semi-allways, 230, 265
 sensitivity of, 149, 250, 280
 setting screw of, 152
 shipping head of, 170
 slider of, 127
 stresses in, 131
 supersensitive, 126, 146, 255
 superquick, 125, 152, 155, 160, 162, 254
 tail bomb, 217, 254, 273
 tests of, 134
 time, 125, 155, 159, 160, 170, 256, 258,
 263, 269
 tracer, 63, 140, 150
 transverse, 254
 Fuze arming, 127, 135, 140, 251
 Fuze primer, 45
 Fuze seat liner, 216
 Fuze system, 144

 Gage, shotgun shell, 64
 Gallery practice, 65
 Gas check, 117, 193
 Gas volume, 46, 50
 Gasless powder, 357
 Gear reduction, 278, 280
 Gelled gasoline, 239
 General-purpose bomb, 8, 220, 222, 258,
 288
 Gilding metal, 40, 98
 Glide angle, 202
 Glide bomb, 202, 373
 Grain, powder, 21, 24, 80, 328
 Granulation, 28, 297
 Grappling hook, 120
 Graze impact, 139, 152, 280
 Grenade, 8, 354
 antitank, 361
 automatic-time, 355
 chemical, 355, 359
 classification of, 9
 contact, 355
 dummy, 355
 fragmentation, 9, 355, 358, 360
 frangible, 359
 fuze of, 356
 hand, 30, 354, 358
 illuminating, 359
 incendiary, 355, 359
 offensive, 9, 355, 359
 practice, 355, 359
 projection adapter of, 360
 rifle, 6, 66, 354, 357, 360
 smoke, 362
 Grenade launcher, 360

- Grommet, 172, 387, 392
 Groove, safety, 333, 341
 Ground glass, 46
 Ground illuminant, 292, 307
 Ground pyrotechnics, 8, 291, 298, 307
 Ground signal, 292, 298, 323
 Guard ammunition, 65, 83
 Gun, aircraft, 178
 antiaircraft, 3, 159, 173, 178, 190
 antitank, 3, 139, 173, 178
 definition of, 3
 field, 3, 173
 machine, 64, 352
 seacoast, 53, 109
 subcaliber, 176, 178, 179
 tank, 178, 191
 Guncotton, 25
- Haleite, 37
 Hand grenade, 30, 354, 358
 Handle, rope, 388
 Handling test, 136, 380
 Hangfire, 67, 71
 Hard-surface test, 210
 Hardness, shot, 108
 Head, arming, 278
 Headlite bullet, 78
 Headlite tracer, 77
 HEAT shell, 108, 110, 112, 138, 181
 Hedge-hopping bombing, 201
 Helix bomb, 230
 Hexachlorethane, 107
 High-altitude bombing, 200
 High-burst ranging, 126, 155, 159, 301
 High explosive, 17, 30, 34
 High panel test, 213
 Hollow-charge effect, 42
 Homogeneous plate, 112
 Hook and cable cluster, 246
 Howitzer, 3, 128
 HPT ammunition, 83, 106
 Hunting, 66, 84
 HVAP shot, 108, 111, 112
 Hydrocyanic acid, 104
 Hydrostatic fuze, 231, 250, 256, 286
 Hygroscopicity, 25
- Igniter, bag, 184, 334
 dim, 77
 rocket, 333, 340, 346
 squib, 59
 tracer, 61, 77
 Ignition cartridge, 55, 192
 Illuminant, 8, 307, 315, 324
 Illuminating grenade, 359
 Illuminating projectile, 86, 117, 163, 301
- Illumination, airport, 304
 flare, 308
 ground, 117, 301, 303, 308
 Immersion test, 381
 Impact, angle of, 199
 graze, 139, 152, 280
 of bomb, 203
 secondary, 200, 227, 285
 Impact fuze, 125, 151
 Impact sensitivity, 31
 Impact velocity, 199
 Improvised mine, 367
 Impulse, primer, 46, 49
 Incendiary ammunition, 8, 65, 71, 75, 99,
 234, 355, 359
 Incendiary agent, 104
 Increment charge, 181, 184, 192
 Inertia plunger, 138
 Inhibitor, powder, 25
 Initiation sensitivity, 33, 111
 Initiator, 34, 35, 123
 Insecticide mortar, 321
 Insensitive explosive, 109
 Inspection, 69
 Instantaneous fuze, 254
 Interchangeability of fuze, 124, 144
 Interior ballistics, 87
 Interplant packing, 383, 385
 Interrupter, fuze, 151
 Iridite dipping, 14
 Irritant, 104
- Jacket of bullet, 73
 Jet, rocket, 326, 327, 352
 shaped-charge, 43, 113
 Jolt-and-jumble test, 135
 Jolt machine, 135
 Jumble machine, 136
 Jungle warfare, 84, 113, 160, 162
- Kraft paper, 385
- Lacquer, protective, 14
 Lacrimator, 104
 Land, 98
 Land mine, 363
 Landing flare, 317
 Launcher, automatic, 350
 grenade, 360
 multiple, 350
 pyrotechnic, 293
 rocket, 5, 195, 326, 332, 349
 zero-length, 332, 350
 Launcher rail, 331, 349
 Launcher signal, 300
 Launcher tube, 331, 349

- Lead, tetryl, 147, 149
- Lead azide, 35, 46, 56
- Lead-plate test, 57
- Lead spitter fuze, 30
- Lead sulphocyanate, 40, 46
- Length, weapon, 4, 21
- Lewisite, 104
- Lifting lug, 216
- Limited-standard ammunition, 13
- Liner, metal, 386, 396
 - shaped-charge, 41, 43, 110
- Loading authorization, 28
- Loading density, 80, 176, 210
- Loading reconsolidation, 57
- Loading test, 96
- Lock nut, 216, 283, 393
- Lot numbers, ammunition, 13
 - powder, 13, 28
- Low explosive, 17, 28
- Low-level bombing, 201, 228, 265, 274
- Lug, lifting, 216
 - suspension, 207, 216, 241

- M number, 11, 174, 215
- Machine gun, 64, 352
- Magazine charge, 156, 163
- Marker, marine, 321
 - slick, 313
- Marking, of artillery, 97, 175
 - of bomb, 220
 - of cartridge, 78
 - of primer-detonator, 275
- Mass production, 125, 149
- Masthead bombing, 201
- Material, 12
 - fuze, 126
- Matériel, 12
- Meal powder, 29
- Mechanical time fuze, 155, 283
- Medium-altitude bombing, 201
- Mercury cracking, 70
- Mercury fulminate, 35, 46, 56
- Metal box, 390
- Metal container, 386, 389
- Metal crate, 394
- Metal-lined box, 386
- Mine, activator, 363
 - antipersonnel, 9, 354, 363, 367, 369
 - antitank, 9, 354, 363
 - beach-defense, 9, 363
 - bouncing Betty, 363, 367
 - classification of, 9, 363
 - firing device of, 367
 - hasty, 366
 - heavy, 365
 - improvised, 367
- Mine, land, 363
 - light, 366
 - metallic, 363
 - non-metallic, 363, 366
 - practice, 363, 366
 - submarine, 195
- Miner's fuze, 29
- Minex, 38
- Minol, 34, 38
- Mk number, 11
- Mobility, 6, 180, 191
- Moisture-vaporproofing, 384
- Monobloc shot, 112
- Mortar, 3, 5, 128
 - ballistic, 33
 - chemical, 164, 191
 - heavy, 118
 - increment, 192
 - insecticide, 321
 - rifled-bore, 118, 160
 - smoke, 120
 - smooth-bore, 118, 160
 - trench, 27, 160, 191
- Mortar complete round, 191
- Mortar fire, 192
- Mortar fuze, 126, 160, 162
- Mortar primer, 55
- Mortar projectile, 117, 118, 163
- Motor, rocker, 27, 326, 333, 341
- Multiperforated grain, 24
- Munroe effect, 42
- Mustard gas, 104
- Muzzle flash, 25, 27, 188
- Muzzle velocity, *see* Velocity

- Navy ammunition, 61, 117, 149, 215, 231, 271, 274, 280, 326, 344, 383
- Needle valve, 238
- Neumann effect, 42
- Nitrocellulose, 25, 328
- Nitroglycerine, 27, 329, 340
- Nitrostarch explosive, 30, 358
- Nomenclature, 10, 65, 174, 215, 249
- Non-delay fuze, 125, 255
- Non-persistent agent, 104
- Normal charge, 188
- Nose bomb fuze, 216, 254, 256
- Nose pad, 227, 233
- Nozzle, rocket, 326, 327, 333
- Nozzling, 327
- NRC compound, 14
- Number, lot, 13, 28

- Obturation, 123
 - primer, 47
- Offensive grenade, 9, 355, 359

- Ogive, false, 145, 169
 radius of, 75
 shell, 91, 92, 98, 118, 145
 Oil, preservation, 384
 Ordnance, definition of, 1
 Ordnance material, 1
 Overseas packing, 384
 Overwrapping, 384

 Packing, cloverleaf, 387
 container for, 385, 387, 398
 cradle for, 396
 crate for, 387, 392, 394
 drum for, 396
 interplant, 383, 385
 metal box for, 390
 metal container for, 389, 396
 method I, IA, II, 384, 385
 of aircraft ammunition, 393
 of ammunition, 377, 387
 of artillery ammunition, 387
 of bomb, 393, 394
 of cluster, 394
 of fixed ammunition, 391
 of miscellaneous ammunition, 396
 of mortar ammunition, 390
 of semifixed ammunition, 391
 of small arms, 396
 overseas, 384
 palletized, 382
 requirements of, 379
 skid for, 383
 test of, 380
 wood box for, 382
 Packing box, 378, 380, 382, 388, 390, 396
 Packing can, 385
 Rad, bomb, 227, 232, 233
 Paint, acid-proof black, 14
 protective, 14
 Painting, 175, 220
 Pallet, 382
 Parachute artillery, 117
 Parachute bomb, 198, 216, 226, 228, 240,
 265, 285
 Parachute container, 230
 Parachute pyrotechnic, 9, 293, 299, 317
 Pathfinder pyrotechnics, 321
 Pawl, arming, 218, 251
 Pendulum, ballistic, 33
 friction, 31
 Penetration, 44, 87, 96, 140, 152, 182
 of bomb, 203, 223
 of bullet, 71, 75
 of shaped charge, 44
 of shot, 108, 112
 Pentolite, 34, 38, 111, 254, 343, 361

 Percussion primer, 51
 Perforation, powder, 24
 Persistent agent, 104
 PETN, 35
 Pettman cement, 14
 Phosgene, 104
 Phosphorus, 105, 106
 Photoflash bomb, 269, 318, 320
 Photoflash cartridge, 320
 Photography, night, 319
 Picatinny Arsenal, 31, 133
 Picratol, 34
 Pin, arming, 250, 251, 256
 bore riding, 128, 161, 336
 cocked firing, 250, 274, 279, 364
 firing, 56, 139, 142, 146, 249
 pull, 128, 159, 161, 163
 safety, 157, 161, 338, 356
 setback, 159, 161
 setting, 259
 Pistol, 64
 pyrotechnic, 8, 293
 Very, 293
 Plastic explosive, 37
 Plastics, 41, 56, 126, 127, 149, 280, 340,
 350, 386
 Plate, face-hardened, 108, 112
 homogeneous, 112
 Plating, 14
 Plug, cartridge case, 190
 closing, 218, 393
 eye-bolt lifting, 172, 392
 shipping, 393
 Plunger, fuze, 128, 138, 139, 250
 Point detonating fuze, 125, 143, 150, 160
 Point fuze system, 128, 144, 151
 Powder, ballistite, 28
 black, 28, 115, 138, 147, 193, 262, 270,
 340, 357
 blending of, 28
 charge of, 181, 184
 commercial, 29
 composite, 329
 cooling agent for, 25
 cord, 24
 cordite, 28
 delay, 277, 357
 double-base, 27, 193, 328
 drum for, 396
 EC blank, 30, 354, 358
 energy content of, 25, 27, 328
 flake, 27
 flash of, 21
 FNH and NH, 25, 26
 fuze, 29, 357
 gasless, 357

- Powder, grain of, 21, 24, 80, 328
 inhibitor for, 25
 loading authorization for, 28
 lot numbers of, 28
 meal, 29
 nibbling of, 193
 perforated, 24
 photoflash, 318
 pyro, 25
 rocket, 27, 328, 335
 rolled, 28
 sheet, 27
 single-base, 25
 small-arms, 78, 80
 smokeless, 21
 stabilizer for, 25
 stacked, 184, 189
 uses of, 29
 web of, 24
 Powder bag, 180, 184, 334
 Power, explosive, 19
 Pressure, air, 258, 262
 blast, 203
 chamber, 4, 5, 88, 190
 in rocket, 330, 335
 test of, 70
 Primacord, 373, 376
 Primer, 12, 19, 45
 artillery, 12, 27, 45, 51, 171
 combination, 54
 commercial, 46
 crushing action of, 46
 drop test for, 48
 electric, 51, 53
 flash of, 46, 51
 friction, 51, 54
 fuze, 45
 gas volume of, 46, 50
 mortar, 55
 obturated, 47
 percussion, 51
 sensitivity of, 46, 48
 small-arms, 45, 78, 80
 stab-action, 46
 Primer-detonator, 218, 249, 275
 Primer impulse, 46, 49
 Primer mixture, 46, 56
 Projectile, AP, 60, 86, 108, 109, 138
 artillery, 86
 canister, 113
 chemical, 105, 120
 cylindrical, 119, 160, 192
 drill, 114
 dummy, 114
 high-explosive, 86, 98, 118, 160
 illuminating, 86, 117, 163, 301
 mortar, 117, 118, 163
 ogive of, 91, 92, 98
 practice, 113
 proof, 114
 proportions of, 91
 requirements of, 87
 smoke, 106
 special-purpose, 120
 tear-drop, 118, 160, 192
 test of, 96
 training, 115
 Projector pyrotechnic, 8, 293
 Projector signal, 298
 Propaganda shell, 121
 Propellant, 17, 21, 80, 171, 328, 335
 Propelling charge, 171, 181, 192
 Pyro powder, 25
 Pyrocotton, 25
 Pyrotechnic, aircraft, 8, 195, 292, 308, 315
 burning rate of, 294
 burning time of, 294, 303, 305, 315
 classification of, 8, 293
 ground, 8, 292, 298, 307
 illuminant, 8, 291, 315
 pathfinder, 321
 projector, 8, 293
 signal, 8, 291, 298, 308
 visibility of, 296
 Pyrotechnic candle, 293, 296
 Pyrotechnic composition, 293
 Pyrotechnic flare, 8, 303
 Pyroxylin, 25

 Rack, bomb, 218, 241
 Radio-controlled bombing, 202
 Radio equipment destructor, 370
 Range, 92, 97, 141, 145, 170, 174, 180, 182, 187, 194, 198, 303, 305
 Range angle, 198
 Rate, of burning, 17, 21, 29, 60, 77, 155, 294, 302, 307, 323, 328, 330
 of detonation, 17, 33
 RDX, 34, 37, 224, 354, 376
 Recoil, rocket, 353
 Reconnaissance flare, 317
 Recovery firing, 138
 Red tracer composition, 62
 Reduction gear, 278, 280
 Relay, 20, 123
 Release altitude, 199
 Release mechanism, cluster, 241, 245
 Resistance, air, 91, 130
 of target, 204, 223
 Resistance ring, 140
 Resistance washer, 141

- Revolver, 64
- Ricochet, 154, 285
- Rifle, 2, 3, 64
- Rifle-grenade, 6, 66, 354, 357, 360
- Rifle-grenade cartridge, 81
- Rim fire, 79
- Ring, resistance, 140
 - time-train, 157
- Rocket, 5, 128, 195, 326
 - acceleration of, 335
 - accuracy of, 331, 347, 352
 - advantage of, 352
 - antiaircraft, 343
 - armor-piercing, 9, 332, 347
 - bazooka, 329, 335, 342
 - chemical, 9, 332, 339
 - classification of, 9, 332
 - disadvantage of, 352
 - drill, 9
 - fin-stabilized, 9, 331, 345
 - HEAT, 335, 347
 - high-explosive, 9, 332, 341
 - practice, 9, 332
 - range of, 335, 342, 352
 - service, 9, 332
 - shaped-charge, 347
 - smoke, 9, 339
 - spin-stabilized, 9, 331, 347
 - target, 343
 - temperature limits for, 330, 352
 - throat of, 327
 - thrust of, 327
 - trap assembly of, 334
 - venturi of, 327
- Rocket ammunition, 9, 326
- Rocket chamber, 326, 327
- Rocket components, 332
- Rocket fuze, 165, 333, 337
- Rocket head, 326, 333
- Rocket igniter, 333, 340, 346
- Rocket jet, 326, 327, 352
- Rocket launcher, 5, 195, 326, 332, 349
- Rocket motor, 27, 326, 333, 341
- Rocket nozzle, 326, 327, 333
- Rocket powder, 27, 328, 335
- Rolled powder, 28
- Rope handle, 388
- Rosette powder, 24
- Rotating band, 93, 98
- Rotating-drum test, 380
- Rotation, of artillery, 88, 92, 124, 129, 197
 - of rocket, 335
 - of shaped charge, 44
 - small-arms ammunition, 72
- Run-down test, of detonator, 58
- Run-down test, of primer, 48
- Rupture test, 214
- Safety, 87, 122, 123, 124, 128, 138, 140, 146, 148, 157, 159, 161, 165, 198, 201, 210, 249, 251, 262, 280, 333, 338, 356
- Safety element, 138
- Safety fuse, 29
- Safety groove, 333
- Salt spray test, 14
- Saluting, 115
- Salvo bombing, 241
- Sand test, of detonator, 77
 - of explosive, 33
- Screwed-in tracer, 61
- Sealed container, 385
- Sealing materials, 14, 109
- Secondary impact, 200
- Self-destructing tracer, 61
- Semi-allways fuze, 230, 265
- Semifixed ammunition, 7, 171, 180, 391
- Simple firing pin, 142
- Sensitivity, friction, 31
 - of detonator, 58
 - of explosive, 30, 111
 - of fuze, 149, 250, 280
 - impact, 31
 - of primer, 46, 48
 - rifle-bullet, 31
 - to initiation, 33, 111
- Separate-loaded ammunition, 7, 114, 172, 184, 392
- Setback, in artillery, 93, 96, 124, 127, 131, 195
 - in rocket, 335
 - in small-arms ammunition, 72
- Setback pin, 159, 161
- Setforward in bomb design, 208
- Setforward ratio, 207
- Setting time, 159
- Shackle, bomb, 218
- Shaped charge, penetration of, 44
 - proportions of, 43
 - rotation of, 44
- Shaped-charge ammunition, initiation of, 44, 111
- Shaped-charge bomb, 240
- Shaped-charge demolition block, 376
- Shaped-charge detonator, 336
- Shaped-charge effect, 41, 110, 138, 141, 336
 - application of, 44, 240
- Shaped-charge liner, 41, 43, 110
- Shaped-charge rocket, 347
- Shell, *see also* Projectile

- Shell, artillery, 91, 86
 - base-ejection, 107
 - base-ignition, 107
 - capacity of, 87, 119, 160
 - chemical, 101, 105, 120
 - HEAT, 108, 110, 112, 138, 181
 - high-explosive, 98
 - propaganda, 121
 - shotgun, 6, 64, 66, 84
 - smoke, 106, 120
- Shell filler, 87, 104
- Shellac, 14
- Ship, 117, 232
- Shipping band, 393
- Shipping head, 170
- Shipping plug, 393
- Shot, AP, 108
 - cap, 108, 112
 - hardness of, 108
 - HVAP, 108, 111, 112
 - monobloc, 112
 - penetration of, 108, 112
 - solid, 109
 - three-piece, 103
 - two-piece, 109
- Shot cartridge, 84
- Shotgun shell, 6, 64, 66, 84
- Shrapnel, 100
- Sight, line of, 198
- Signal, 8
 - aircraft, 308, 323
 - cartridge, 312
 - colored-smoke, 300
 - distress, 320
 - drift, 313
 - flash-and-sound, 301
 - ground, 292, 298, 323
 - high-burst ranging, 301
 - launcher, 300
 - projector, 298
 - star, 311
- Silhouette test, 213
- Silica gel, 386
- Single-base powder, 25
- Skid, 383
- Skip bombing, 201, 227, 252, 274, 279
- Slick marker, 313
- Slider, fuze, 127
- Sliver, powder, 24
- Small arms, 3, 64
- Small-arms ammunition, 6, 64, 195, 396
 - AP, 65
 - API, 65
 - API-T, 65
 - ball, 65
 - blank, 6, 65, 80
- Small-arms ammunition, classification of,
 - 6, 65
 - dummy, 65, 82
 - grades of, 68
 - guard, 65, 83
 - hangfire in, 67, 71
 - HPT, 66, 83
 - incendiary, 65, 71, 75
 - inspection of, 69
 - packing of, 396
 - powder, 78, 80
 - rifle-grenade, 6, 65, 360, 362
 - shotgun-shell, 84
 - subcaliber, 66
 - tests of, 70
 - tracer, 61, 65, 71, 77
- Smoke, colored, 183, 300, 359, 362
 - fuming, 105
 - screening, 104
- Smoke bomb, 8, 220, 234, 237, 268
- Smoke grenade, 362
- Smoke shell, 106, 107, 120
 - canister for, 107
- Smokeless powder, 21
- Smooth-bore mortar, 118, 160
- Snake, land, 375
- Solvent, 281
- Spin-stabilized rocket, 9, 331, 347
- Spotting charge, 239
- Squib, 59, 340
- Stab-action detonator, 57, 123
- Stability, in artillery, 94, 95
 - of bomb, 207
 - of explosive, 31
 - of rocket, 331
 - of small arms, 71
- Stability factor, 73, 94, 95, 208
- Stabilizer, 25, 193
- Stacked powder, 184, 189
- Standard ammunition, 13
- Standoff distance, 43, 113
- Stem, arming, 260, 273
- Sternutator, 104
- Stress, in bomb, 209, 214
 - in fuze, 131
 - in shell, 93
- Striker, fuze, 149, 260
- Subcaliber ammunition, 6, 66, 176, 178, 179
- Submarine mine, 195
- Substitute-standard ammunition, 13
- Supercharge, 188
- Superquick fuze, 125, 152, 155, 160, 162, 254
- Supersensitive fuze, 126, 146, 255
- Surface burst, 125, 138, 144

- Surface treatment, 14
 Surveillance, 31, 238, 381
 Suspension band, 216
 Suspension lug, 207, 216, 241
 Swivel loop, 218, 251
 Systemic poison, 105
- T number, 11, 174, 215
 Tail bomb fuze, 217, 254, 273
 Tail cone, 192
 Tail pad, 227, 273
 Tank, 112, 182, 350
 Tank armor, 108, 120
 Tank weapon, 113, 120, 173, 178, 191
 Target, for bomb, 223, 227, 229, 232, 235
 resistance of, 204, 223
 Target rocket, 343
 Tear-drop projectile, 118, 160, 192
 Tear gas, 104
 Tear strip, 385
 Temperature, rocket, 330, 352
 Terminal ballistics, 88
 Terminal velocity, 199
 Terneplate, 387
 Test, arming, 135
 bomb, 212, 213
 conbur inclined, 381
 casualty, 71
 delay element, 138
 detonator, 134
 drop, 48, 96, 132, 210, 380
 elongation, 214
 firing, 96, 136
 fuze, 134
 handling, 136, 380
 hard-surface, 210
 high-panel, 213
 immersion, 381
 jolt-and-jumble, 135
 lead-plate, 57
 loading, 96
 low-panel, 213
 packing, 380
 projectile, 96
 rotating-drum, 380
 rupture, 214
 salt spray, 14
 sand, 134
 setback, 96
 silhouette, 213
 surveillance, 381
 sympathetic detonation, 382
 transportation, 136
 vibration, 380
 welding, 214
 Tetrinol, 34, 38
- Tetryl, 34, 36, 147, 165
 Tetrytol, 34, 36, 376
 Thermate, 235
 Thermite, 105
 Throat of rocket, 327
 Thrust of rocket, 327
 Time fuze, 125, 155, 159, 160, 170, 256,
 258, 263, 269
 Titanium tetrachloride, 105
 TNT, 34, 36
 Torpedo, aircraft, 195
 bangalore, 120, 375
 Torpex, 34, 231
 Tow-target flare, 316
 Trace, time of, 61, 77
 Tracer, 45, 60
 ammunition, 65
 closure of, 63
 composition of, 61, 62, 77
 fuze, 63, 140, 150
 headlite, 77
 igniter in, 61, 77
 percussion, 63
 projectile with, 109
 screwed-in, 61
 self-destructing, 61
 small-arms, 61, 65, 71, 77
 Trail angle, 198
 Trail plate, 318
 Train, explosive, 19, 45, 122, 135, 218,
 249, 276
 Trajectory of bomb, 198, 199, 252
 Transportation test, 136
 Transverse fuze, 254
 Trap assembly of rocket, 334
 Trench mortar, 27, 160, 191
 Trip flare, 303
 Tritonal, 34
 Trunnion band, 216
- Unequal-section charge, 185
- Vane, anemometer, 239, 285
 arming, 250, 251, 256
 Vane cup, 260
 Vaporproofing, 384
 Varnish, protective, 14
 Velocity, fragment, 214
 impact, 199
 muzzle, 4, 5, 88, 178, 182, 187, 194, 335
 rocket, 342
 terminal, 199
 Venturi, 327
 Very pistol, 293
 Vesicant, 104
 Vibration test, 380

- Visibility, pyrotechnic, 296
Vomiting gas, 104
- Washer, resistance, 141
 tension, 157
- Water weight, bomb, 211
- Waterproofing agent, 294, 384, 385
- Waterproofness, of detonator, 58
 of packing, 381, 384
 of pyrotechnic, 294
 of small arms, 70
- Wax pad, 233
- Weapons, comparison of, 4, 6
 type of, 3
- Web, powder, 24
- Weight, of bomb, 211, 220
 of packing, 387
- Weight, of weapon, 4, 5, 6
- Weight zones, 97
- Welding, 214, 223
- Wiggly pin, 168
- Wind tunnel, 251
- Windshield, 109, 111
- Wire, arming, 216, 217, 251
- Wood box, 382, 388, 394, 398
- Yaw, 73, 95
- Yellow ano-zinc plating, 14
- Zero-length launcher, 332, 350
- Zinc plating, 14
- Zone, of howitzer, 182, 187
 of mortar, 194
 weights, 97