

DISTRIBUTION

	Scale
All Arms	D
OCTUs.	IV
ORTUs.	D
SAS. Hythe Wing	140
SAS. Netheravon Wing	100

CONTENTS

	Page
General notes for instructors	1

CHAPTER I:- MAINTENANCE

Lesson 1:- Cleaning	4
Lesson 2:- Examination of the rifle	7

CHAPTER II:- AIMING INSTRUCTION

Lesson 3:- The correct aim	9
Lesson 4:- Aiming off the target	11

CHAPTER III:- FIRING INSTRUCTION

Lesson 5:- Loading and unloading	14
Lesson 6:- Holding and trigger pressing	16
Lesson 7:- Firing from low cover	19
Lesson 8:- Other positions	21
Lesson 9:- Firing at moving targets	24

CHAPTER IV:- QUICKENING AND STRENGTHENING EXERCISES**CHAPTER V:- TESTS OF ELEMENTARY TRAINING**

Appendix I:- Care of No. 2 .22-inch rifle	28
Appendix II:- Variations in teaching the No. 3 rifle	29
Appendix III:- Variations in teaching the No. 4 rifle	30
Appendix IV:- Sniper rifle and zeroing '18 and Aldis telescope	32
Appendix V:- The No. 4 Sniper rifle	37
Appendix VI:- The Sniper sling	39

GENERAL NOTES FOR INSTRUCTORS

The object of weapon training

1. The sole object of weapon training is to teach all ranks the most efficient way of handling their weapons in order to kill the enemy. Instructors will always bear this fact in mind, and will continually impress it upon those whom they instruct.

General points of safety

2. Before commencing any lesson in this pamphlet, instructors will invariably inspect rifles, drill cartridges and pouch equipment. They will also show their own to the squad. It is only by the strictest adherence to this principle that accidents with live S.A.A. will be avoided.

3. When using the aiming disc, or firing at another man's eye, drill cartridges will NEVER be used.

Recruit instruction

4. Instructors must appreciate that, while the lessons are designed to be taught in one period, more time will be necessary for practice and revision to obtain proficiency.

Trained soldier instruction

5. Once men have been trained in the elementary handling of the rifle, all future instruction must then be progressive as it is useless to exercise trained men as if they were recruits. The following are ways in which further useful instruction can be given:-

- i. T.E.T. to ensure that men have not lost their skill. Interest can be developed if the men themselves are required to point out faults.
- ii. Lessons 7, 8, and 9, together with the quickening exercises.
- iii. Carrying out these lessons on different types of ground, involving as many different types of firing positions and cover as possible.
- iv. Paying the fullest attention to tactical considerations and the importance of concealment from the enemy, including camouflage measures, so as to permit seeing without being seen.
- v. Explaining the limitations of rifle fire, and teaching, by demonstration within the squad or otherwise,

what are easy and what are difficult targets for men armed with rifles.

Improvisation

6. Instructors must make every effort to improvise any training stores that may be needed.

Provided that weapons and cleaning stores are issued, then all essential lessons can be taught by improvising where and when necessary. For details *see* heading "Stores Improvisation" under the different lessons.

Drill cartridges

7. Where these do not exist, the whole training can be carried out without them, but every effort should be made to obtain them for use.

CHAPTER I- MAINTENANCE

(LESSONS 1 AND 2)

Object:- To teach the soldier from the beginning of his service that he must take proper care of his weapons so that they are always at the maximum efficiency for killing the enemy.

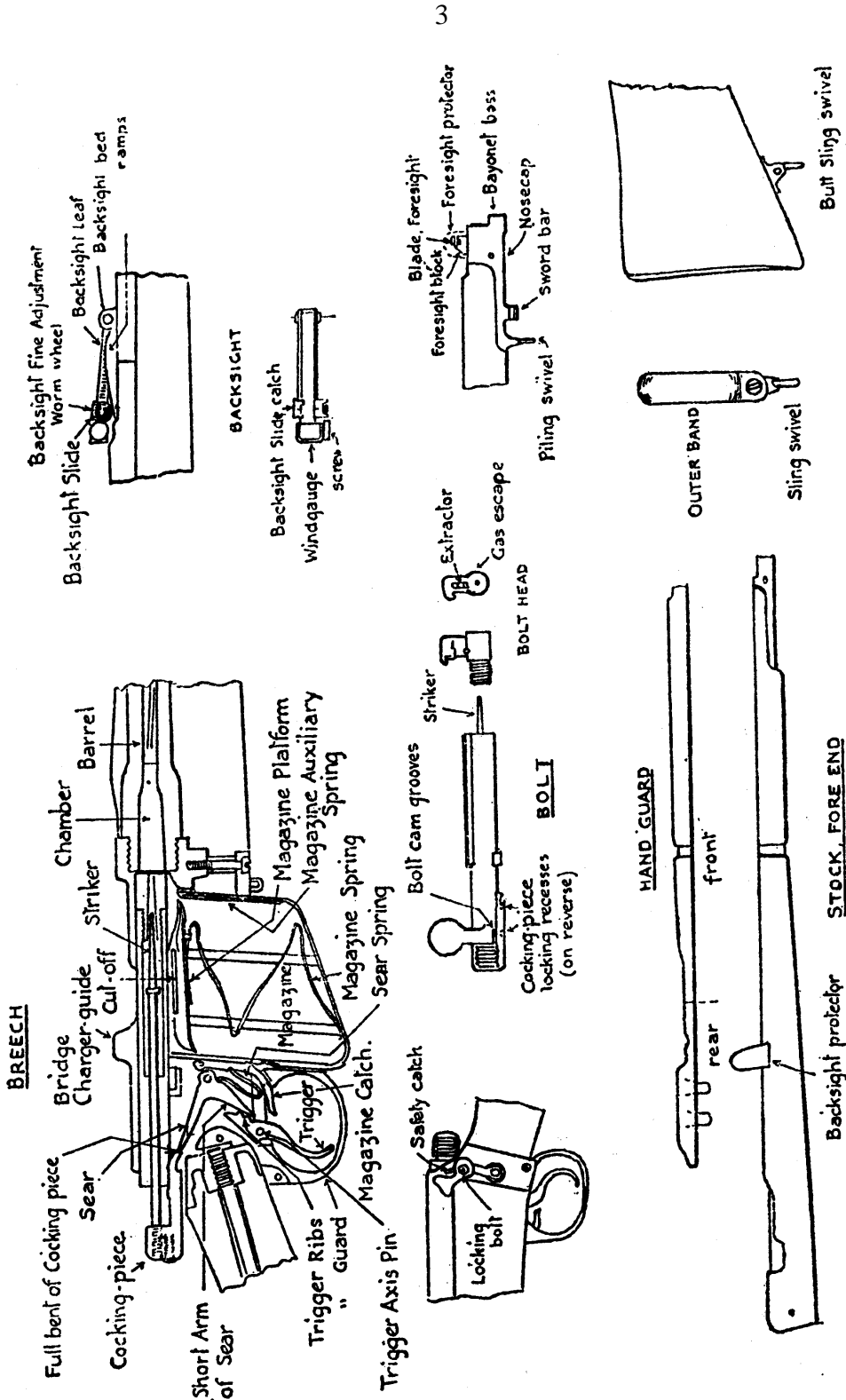

FIG. 1.

LESSON 1:- CLEANING

Instructor's Notes

Stores:-

All cleaning materials.

Safety precautions (see General Notes for Instructors).

Name all parts of the rifle as dealt with. This applies to all rifle instruction (see Fig. 1).

1. Explain that if the rifle is cleaned and handled correctly it is capable of a high and accurate rate of fire.

If, as will normally be the case, the men of the squad have previously witnessed a demonstration to show the effect of rifle fire, reference will be made to it. Otherwise, the squad will be told the grand effect of the fire delivered by capable men whose weapons are in the best possible condition.

Explain and demonstrate with squad imitating:-

2. Stripping

- i. Identify rifle by numbers on bolt lever and right of body.
- ii. Remove bolt - push safety catch forward, press cut-off down and out, raise knob and draw bolt right back, press bolt head upwards, disengaging it from retaining spring and remove bolt.
- iii. Remove magazine by pressing home magazine catch.
- iv. Open butt trap and remove oil bottle and pull-through. Unroll and straighten out pull-through. Remove sling.
- v. Fitting gauze:- In war-time the gauze will be kept fitted to the pull-through. To fit it, fold it as in Fig. 2, the longer sides taking the shape of an "S." Open the loop of the pull-through nearest the weight and put one side of it in each loop of the "S." Coil each half of the gauze tightly round the cord until the two rolls thus formed meet. Remove loose strands. To make the gauze fit the bore tightly, pack it with a small piece of flannelette if necessary. The gauze will always be oiled before use.

WIRE GAUZE FOLDED (Section) .

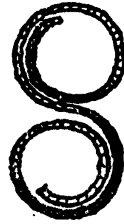

ON PULL-THROUGH

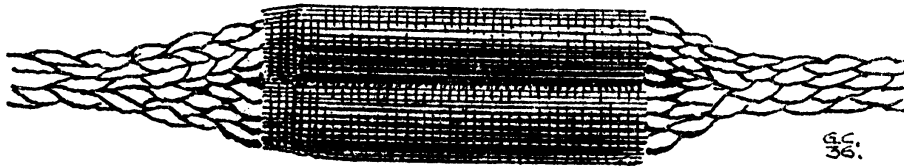

FIG. 2.

3. Cleaning the barrel

- i. Place a piece of flannelette, size 4 inches by 2 inches, in centre loop and wrap it round cord. Insert weight in breech. With butt on ground, pull the cord straight through the barrel. Avoid cord rubbing against the side of the barrel. Repeat as necessary, changing flannelette when required.
- ii. Examine bore by holding muzzle close to the eye, draw head back and look into grooves for dirt. Repeat from breech end. If barrel is clean, oil it with flannelette 4 inches by 1½ inches. Should dirt still be present (as it may be after firing) use water if available.
- iii. Use of water: Pour 5 to 6 pints of water (boiling if possible) carefully through barrel, using a funnel or any other suitable appliance; boiling water is best; hot water is better than cold; but even cold water is better than no water at all. Dry, examine and oil the barrel.

4. Cleaning chamber

Use a stick about a foot long with a slot at the top for flannelette. A piece of flannelette 4 inches by 2 inches should be inserted and wrapped round the stick which is then pushed hard into the chamber and turned several times.

Note:- The best accuracy of fire is obtained if the barrel and chamber are dried before firing.

5. Cleaning outside of rifle

After cleaning barrel and chamber, wipe the dirt from all metal portions, using an oily rag. Make certain all crevices and gas escapes are clean.

6. Cleaning and replacing of bolt and magazine, etc.

- i. Bolt:- Dirt and grit must be removed from all parts. Oil it, except in dusty climates.
- ii. Magazine:- Remove dirt from inside and outside, if necessary remove platform and spring by pressing down wide end. Narrow end is then disengaged from front lips. Remove platform and spring carefully. Replace in reverse order. It should only be removed when necessary.
- iii. Replace bolt:- See that number corresponds with body number. Head should be screwed fully home. See that cocking piece is in line with steel lug and safety catch forward. Push bolt into the body till it meets the charger guide, turn down the bolt head, draw it back to resisting shoulder, press it right down. Close cut-off. Push bolt forward and down. Press trigger and put safety catch back.
- iv. Replace magazine:- Front end first into magazine opening. Press fully home and test it to ensure it is engaged.
- v. Replace oil-bottle head first, then roll up pull-through by holding end of cord in the hand with about 1 inch below the bottom of the hand. Roll loosely once round the hand. Slip coil off and twist remainder of cord tightly round it, leaving enough to allow the weight to drop easily into the recess in butt trap. Push cord into the trap, leaving loop end uppermost and close the trap. Replace sling.

7. Explain the rifle must be examined and cleaned at frequent and regular intervals, particularly after recent firing.

8. Action during and after gas attack

During:-

To keep weapon in working order all parts should be well oiled.

After:-

If splashed with blister gas, weapon must be decontaminated as follows:-

- i. Rub anti-gas ointment into the hands; leave a visible film of ointment on the hands.
- ii. Unless the sling is heavily contaminated it should remain on the rifle, all free liquid being removed with a swab, and ointment applied to the contamination on both sides of the sling.
- iii. Remove all free liquid from the rifle with any available swab (grass, etc.). The personal issue of cotton waste should not be used.
- iv. Rub the contaminated portions of the rifle with ointment vigorously. The ointment should be rubbed well into the woodwork.
- v. Remove ointment from the metal parts of the rifle with a swab and re-oil. Do not remove ointment from the woodwork.
- vi. Wipe off surplus ointment from the hands with cotton waste, then rub more ointment into the hands for half a minute.

9. Ammunition

All free liquid should be swabbed off and the ammunition used as early as possible.

10. Practise and question squad.

LESSON 2:-EXAMINATION OF THE RIFLE

(For officers and N.C.Os. only)

All officers and N.C.Os. must possess a thorough knowledge of the inspection and care of rifles. Young officers will be instructed by the armourer and N.C.Os. by a qualified instructor in the various components of the rifle as below:-

- i. With the barrel dry, examine it for rust, cuts, bulges and fouling.
- ii. Foresight; that blade is not deformed and that nose cap is not loose.
- iii. Backsight, for firmness; that it is not bent; that slide moves smoothly; that thumb-piece and fine adjustment worm work freely and engage in rack on side of leaf; and that "U" is not deformed.
- iv. Magazine; that it is not dented, and that platform works freely; also magazine catch and auxiliary spring present.
- v. Bolt; that it bears same number as body; and that bolt works smoothly.

- vi. Sear; that it holds cocking-piece back securely when bolt is driven forward sharply to closed position.
- vii. Cocking-piece; for firmness on striker.
- viii. Cocking-piece and striker; that they fly forward freely on pressing the trigger. Test both the pressures of the latter.
- ix. Striker point; that it is correct shape and projects sufficiently through face of bolt-head; also extractor and spring.
- x. Safety catch and locking bolt; that safety catch engages in camway of bolt and locks it; that it does not move too easily; and that cocking-piece is withdrawn slightly to rear when locking bolt is applied, whether it is at “full cock” or “fired” position.
- xi. Stock, fore-end and butt; general condition and butt not loose,

CHAPTER II:- AIMING INSTRUCTION

(LESSONS 3 AND 4)

1. *Object:-* To teach the soldier to aim correctly in order to kill the enemy.
2. *Aids:-* Instructors should draw or use diagrams to illustrate rules.
3. *Standard of accuracy:-* Accuracy must always be insisted upon. Targets should be made more difficult as progress is made. The necessity for aiming off the target for wind, etc., should be constantly kept before the man’s mind after the early lessons have been completed. Sights should be frequently inspected to see that they have been adjusted as ordered.
4. *Aim corrector:-* When used, the aim corrector will be placed on the rifle behind the backsight with the reflector glass to the left, sights being raised to about 400 yards to give a clear view..
5. *Stores improvisation*
Aiming Rests and Tripods.

If not available, use a 6-foot table with a filled sandbag on the forward and rear edges. The man under instruction sits on a form or chair. If sandbags are not available, use folded greatcoats, blankets or waterproof sheets. Grooves cut in old boxes is another method which may be used.

Targets

Targets representing enemy can be painted on the sides of walls and buildings, or the regulation paper may be used and pinned on.

- Notes:-*
1. The above applies to all lessons of aiming.
 2. Should the correct full distances not be obtainable, then the size of the targets must be reduced proportionately.
 3. Auxiliary targets and figures for Lesson 4 can be made from sheet metal, wood or cardboard.

LESSON 3:- THE CORRECT AIM

Instructor's Notes

Stores:- Figs. 5, 4a, 3 at 100, 200, 300 yards respectively, and Figs. 2 at 400 and 500 yards.

Aiming rests and tripods.

Safety precautions (see General Notes for Instructors).

Method of checking aims:-

If a man has not aimed correctly, tell him to look again. Should he not see his mistake convince him by placing a piece of paper in front of the muzzle. Tell the man to get his eye over the heel of the butt. He should then move his head until the top of the foresight is in the middle of the "U" and in line with the shoulders. Then remove the paper quickly - after a slight pause replace it and point out where the shot would have gone. If an aim is approximate to the centre of the target, consider it as correct.

1. Sightsetting

- i. Explain and demonstrate, with squad imitating:-
Before aiming, the backsight must be set to the range required. Draw back the rifle so that the sights can be clearly seen. With the left thumb press the stud on the left of the slide and move the slide until the line in centre is even with the mark on the leaf for range ordered. Ensure that it is firmly fixed. If slide, adjusted to a range, does not exactly agree with the line on the leaf, adjust it by pressing in stud on slide with left thumb, at the same time turn worm wheel. Do not press the stud too far home or the slide will not move. Ensure that the above is carried out with the minimum of movement.

- ii. Practise squad.

2. Aiming

- i. Explain rule of aiming:-
Close the left eye and bring the sights up on to the centre of the target with the backsight upright. Top of the foresight must be in the middle of the "U" and in line with the shoulders (show diagram, *see* Fig. 3).

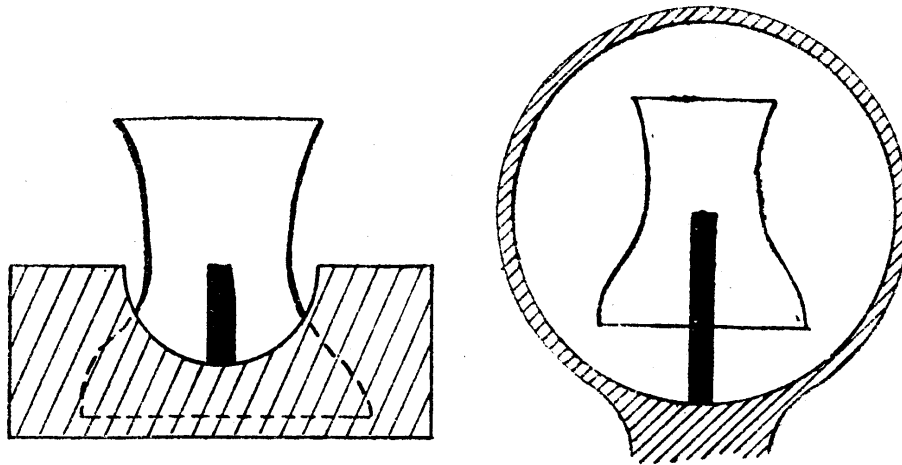

(a) Open sight.

(b) Aperture sight.

Fig. 3.—Correct aim

- ii. Explain and demonstrate how to aim-
Elbow and head rested, eye over heel of butt. Lay an aim at a Fig. 5 target, distant 100 yards. Squad view. Show how to arrange kit required.
- iii. Squad practise. Instructor checks.
- iv. Practise squad at 200, 300, 400, and 500 yards; only demonstrate again where necessary.

3. Elevation

Point out briefly the necessity for elevation by referring to throwing a stone or using hosepipe. Illustrate by laying two rifles on same target, sights adjusted to 200 and 1,000 yards respectively. Each man views aims and looks through bores, instructor explaining:-

- i. Sights 200 yards - sights and bore pointing at mark.
- ii. Sights 1,000 yards - sights on mark, barrel elevated to allow for fall of bullet.

4. Altering sights

Point out that extra or less elevation is, therefore, obtained by altering sights and this should be done when rifle is shooting high or low. A correct aim is still taken.

- i. If rifle shoots low, raise sights 100 yards and fire again. Repeat until target is hit.
- ii. Reverse procedure if rifle shoots high.
- iii. Give problems and practise squad, insisting on correct aim being maintained. As progress is made, alteration of sights and fresh aims should be carried out quickly.

LESSON 4:- AIMING OFF

Instructor's Notes

Stores:- As for Lesson 3.

Safety precautions (see General Notes for Instructors).

If possible, before lesson commences, arrange for correct position of auxiliary in para. 5 of the lesson - aiming down. This can be done by aiming down 1 figure's height and placing auxiliary or some other object there. Then mark the spot.

1. Aiming off for wind

- i. Explain:-
Wind has the same effect on a bullet as it has on a football, only to a much lesser degree. The bullet, therefore, is carried off its course to the target by the wind. To counteract this the firer must *aim off* into the wind.
- ii. Each individual is responsible at all times for making the necessary allowance for wind when engaging the enemy.
- iii. The following rules are a guide for service conditions. They must be applied with common sense according to the strength and direction of the wind. They apply to direct or oblique cross winds, no allowance being necessary for head or rear winds. The firer can tell the direction of wind by its effect on his face or on grass, smoke from weapons, etc.
 - (a) Under 200 yards - no aim off is required.
 - (b) From 200-400 yards inclusive - aim off 1 man's width from the centre.
 - (c) Over 400 yards - aim off 2 men's widths from the centre.

2. Demonstrate what 1 man's width looks like by assistant at 200 or 300 yards, placing auxiliary figure to right or left of target. Instructor aims at auxiliary. Auxiliary removed. Squad view. Instructor points out how elevation is maintained by having half the target resting on the shoulders of the backsight and the foresight in line with the shoulders (show diagram Fig. 4).
3. Practise squad aiming off up to 2 men's widths at various ranges. Check with auxiliary (*see* Fig. 4).

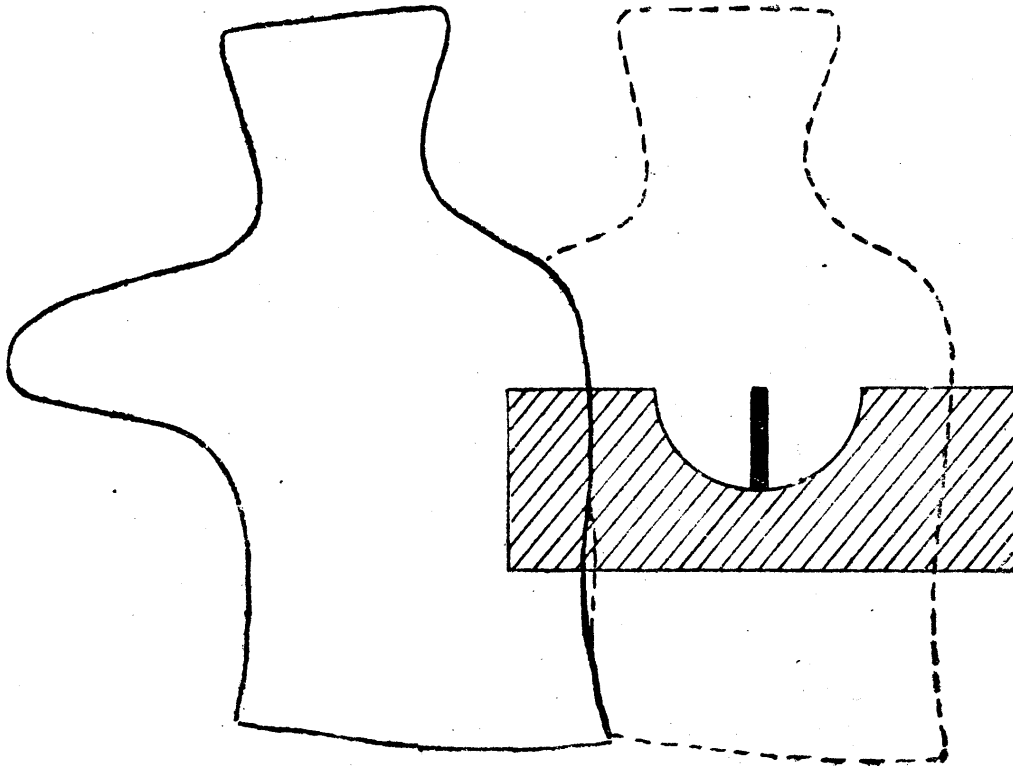

Fig. 4

4. Aiming down

Instructor explains that if shots are observed to be going high at 200 yards, or when time does not allow alteration of sights, the firer must aim down 1 target's height and fire again. This must be done quickly and it may be necessary to aim down more still. Height should be measured from the centre of the target.

5. Practise squad up to 300 yards, using a Fig. 4a target, and check with auxiliary. Finally remind squad that a combination of aiming down and off may be at times required. Practise squad.

Note:- The auxiliary will be the instructor's guide for elevation only.

CHAPTER III:- FIRING INSTRUCTION

LESSONS 5 TO 9

1. Object

To teach the soldier to fire effectively from any type of cover and to ensure by practice that his actions in battle will be instinctive, so that all his thoughts can be concentrated on how best to kill the enemy.

2. Use of left shoulder

A man with normal vision learning to use the rifle can be taught to fire from the right shoulder, for which the rifle is constructed, as easily as from the left. Any inclination to use the left shoulder will, therefore, be discouraged.

3. Fitting rifles

Rifles have long, normal and short butts, and will be issued to men according to their build. The readiness with which the firer can bring his rifle into the aim without having his nose and mouth too close to the thumb and fingers of his trigger hand, will indicate the suitability of the size of his rifle. This test will be made under the supervision of an officer as soon as the recruit has been taught how to fire in the lying position, or whenever a new rifle is issued to him.

4. Declaration of aim

As soon as the man has been taught how to press his trigger he will be informed that, in all firing instruction, he will have to declare his exact aim at the moment the second pressure has been taken, except in rapid fire. The importance of a truthful declaration must be emphasized. Instructors must set a good example, taking care not to acquire a habit of automatically declaring, their own shots correct when demonstrating to young soldiers. This applies to individual but not collective training.

5. Quickening exercises

The instructor will impress on his men the necessity for speed at the first available opportunity. This will only come with constant practice. Therefore the last few minutes of each lesson should be devoted to quickening up in all movements, particularly in getting down and up again, loading. etc. These exercises should occasionally be carried out wearing respirators. Examples of such exercises, which are left to the discretion of instructors, are given in Chapter V.

6. During all firing instruction the soldier will be dressed in battle order.
7. During firing the instructor will continually check aiming and trigger release by means of an aiming disc. Drill cartridges will NOT be used when aims are being checked with an aiming disc.
8. After the initial lessons in loading, the rifle can be loaded in any convenient position, such as standing, providing safety is considered, i.e. muzzle pointed upwards.

LESSON 5:- LOADING AND UNLOADING

Instructor's Notes

Stores:- Suitable targets for each man and instructor.

Safety precautions (see General Notes for Instructors).

Explain how to fill chargers (see Fig. 5).

Extend squad to two paces; allot targets.

Suitable targets for instructor and each man.

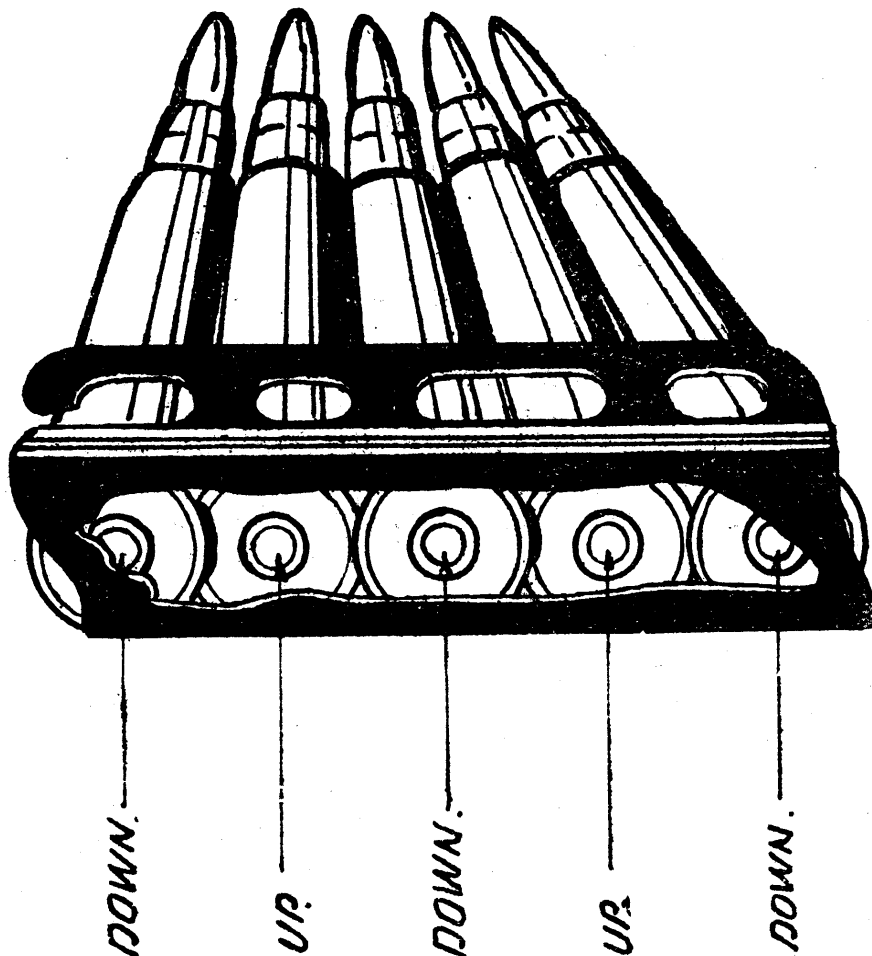

Fig. 5

This lesson can be taught on any rough ground. Speed is essential in getting down, loading, etc.

1. Explain and demonstrate, with squad imitating:-

i. *Lying position*

Holding the rifle at the point of balance with the left hand, lie down quickly, pushing the rifle towards the front. Place the right hand on the small of the butt. The body should be oblique to the front, legs extended.

For correct position see Fig. 6. The rifle must never be used as a support when adopting this position.

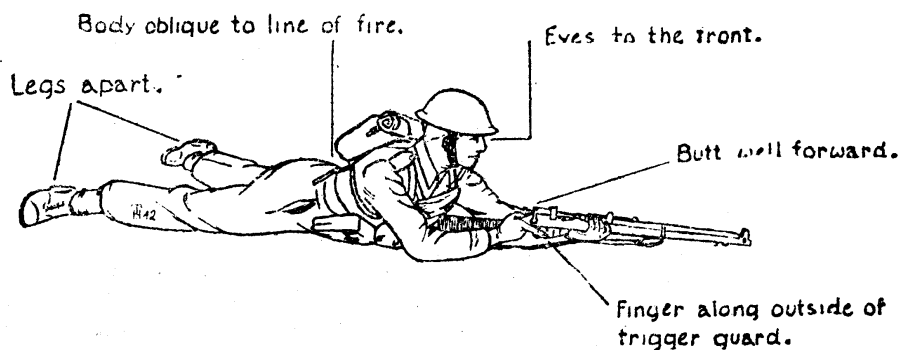

Fig. 6

ii. *Standing up from lying position*

Draw back the rifle and hold it with the left hand at the point of balance. Get up quickly. The rifle must never be used as a support when getting up.

2. Practise squad.

3. **To load, set sights and unload**

i. Explain and demonstrate, squad imitating:-

Lie down and open the breech. With the right hand, take from the pouch one charger of five rounds and place it in the bridge charger guide. Place the ball of the thumb on the top round just in front of the charger, fingers underneath the cut-off or woodwork. Force the rounds into the magazine with one clean sweep. Remove charger and repeat with another charger, making sure that the top round is in the magazine. Close the breech, apply the safety catch and fasten the pouch.

Note:- If no round enters chamber, press the rounds back into the magazine and close the breech.

- ii. *To set the sights*
When the range is ordered, draw back the rifle until the sights can be clearly seen and set the sights with the minimum movement, and resume the correct position.
- iii. *To unload*
Pull the bolt backwards and forwards quickly without lowering the lever until all rounds are clear of the magazine and chamber, close cut-off, breech, press trigger and apply safety catch. Lower the sights and stand up.

4. Practise squad.

5. **Alternative methods of loading and unloading**

Explain and demonstrate, with squad imitating:-

- i. Loading and unloading in the standing position. As in the lying position, but with the rifle kept pointing upwards.
- ii. If unloading in a muddy trench or in the dark, etc., remove the magazine, open breech slowly and remove round from chamber. Close cut-off and breech, press trigger and apply safety catch. Empty the magazine and replace it in the rifle.

LESSON 6:- HOLDING AND TRIGGER PRESSING

Instructor's Notes

Stores:-

Suitable targets for each man and instructor. Aiming disc. Safety precautions (see General Notes for Instructors). Extend squad to two paces, allot targets.

To get the eye back from the cocking piece:-

- i. *Raise the head and draw it back.*
- ii. *Raise the butt higher in the shoulder.*
- iii. *Turn the body less obliquely to the target.*
- iv. *If these methods fail try to get a longer butt.*

Stores Improvisation

Aiming disc:- Any short strip of tin or cardboard, about an inch wide and a few inches long. Paint one side grey with a brown figure 5 on it. Make a small hole in the centre of the figure 5.

1. **Holding and trigger pressing**

i. Explain:-

Correct trigger pressing is essential for accurate shooting. The rifle must be kept still during the pressing of the trigger. This can only be done by having a firm grip with both hands, particularly the *right hand*. The trigger has two pressures which are termed the first and second pressures.

Give order "Without drill cartridges - load - 200"

ii. Explain and demonstrate, squad imitating:-

Look to the front and push forward the safety catch. Lift the rifle so that the butt comes quickly into the shoulder. Pull well in with both hands, the wrist of the left hand being clear of the magazine. Without releasing the grip of the right hand, place the first joint of the forefinger round the lower part of the trigger and squeeze with the whole hand until there is a distinct check to the trigger. This is the first pressure, and will always be taken when the butt is in contact with the shoulder. Lower the cheek to the butt, keeping the eye well back from the cocking-piece. Close the left eye and aim. [See Figs. 7, 8, 9.] When the aim is correct, restrain the breathing and continue the steady squeeze with the right hand until the cocking-piece goes forward. Notice where the sights are pointing at this moment and declare truthfully high, low, etc. (This only applies to slow firing.) Hold the rifle firmly in the shoulder with left hand and, keeping the head still, open and close the breech quickly, avoiding unnecessary movement. Tilting the rifle slightly to the right will assist in reloading. Lower the rifle to the ground.

2. Practise squad. Instructor checks each man with aiming disc, *Drill cartridges will NOT be used.*

3. Half cock and how to remedy

Explain and demonstrate, with squad imitating.

At half cock the trigger cannot be pressed, nor can the breech be opened, until the action is placed at full cock by drawing back the cocking-piece. If firing, apply the above remedy and continue. If the action is found at half cock on other occasions, apply the above remedy, but open the breech to ensure the chamber is clear before pressing the trigger.

4. Give further practice in complete lesson.

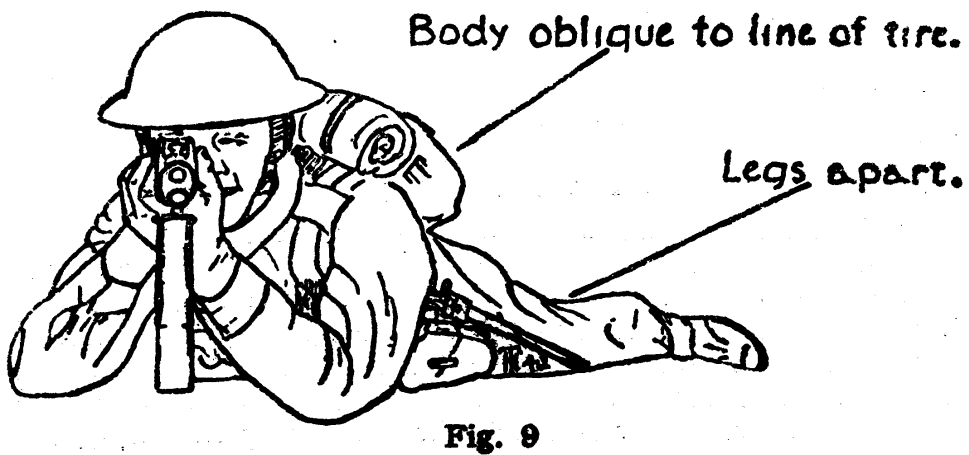
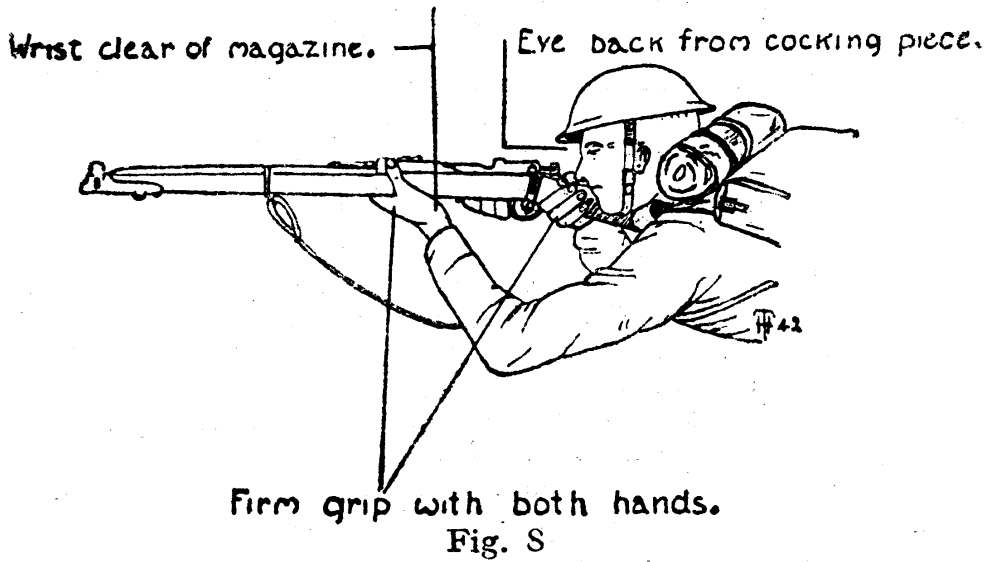
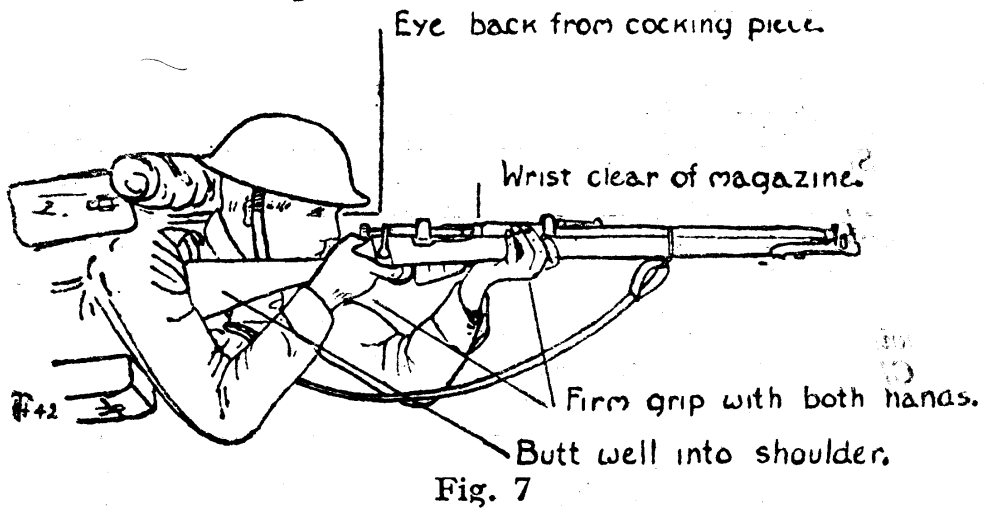

LESSON 7:- FIRING FROM LOW COVER

Instructor's Notes

Stores:-

Suitable targets for each man and instructor.

Safety precautions (see General Notes for Instructors).

This lesson should be carried out using low cover, such as banks, folds in the ground, etc. Do not insist on drill movements. Criticism and corrections will be made by questioning men, thus making them use their own intelligence. Bayonets will be fixed as progress is made. Give order "load" (see Chap. 3, Sec. 8). Squad on right side of cover.

1. Explain:-

The object of firing from cover is to kill the enemy while presenting the smallest possible target to his view or fire. Soldiers must be trained to fire from natural cover, such as banks and ditches or from artificial cover such as trenches, shell holes, buildings, etc. A good fire position should:-

- Permit free use of the weapon.
- Give a good field of fire.
- Be inconspicuous.
- Be bullet proof.
- Be easy to move from.

There are two main points for the soldier to remember when using cover.

- i. Correct resting of the rifle.
- ii. No undue movement or exposure. This necessitates modification of the firer's position to suit the cover.

This lesson deals with all types of low cover.

2. Explain and demonstrate:-

Position of observation:- Used when the firer(s) is watching his front. On the command "Down", lie down as quickly as possible behind the cover and crawl forward so that the front can be seen without undue movement or exposure. The rifle is below cover with the safety catch applied.

Position behind cover:- Used when the Sec. Comd. does not want the whole of the section observing. On the order "Behind cover" the whole of the body and the weapon must be completely concealed behind the

cover, if the order "Watch the front" is given get back into the "Position of observation" again.

Position of readiness:- On the "Range" being ordered, or, if acting individually, set the sights to the estimated range and slide the rifle cautiously forward over the cover and adopt a position as near to the "Loading position" as possible, safety catch forward. On the target being indicated, aim. The left wrist and hand should be rested on the cover if possible. If the cover is hard, then the rifle is rested as near the point of balance as possible, fore end clear of cover. The left hand should be clear of the magazine and hard against the cover, both elbows being rested if possible. When firing from a fold in the ground the body and rifle should be back behind the crest, with the muzzle just above the crest of the cover (see Fig. 10).

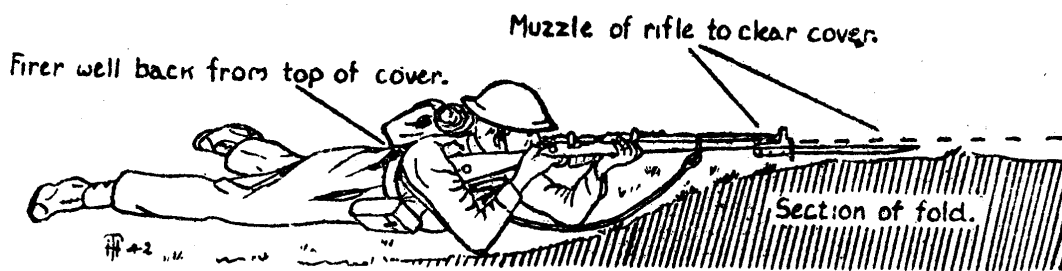

Fig. 10

On the order to fire, carry on as taught in Lesson 6. If possible, keep the rifle in the shoulder all the time during firing, as this will restrict movement and not draw the enemy's attention. Slow fire is only five rounds per minute. On the order "Stop" being given, load with a further five rounds, if there are only five rounds or less in the magazine. This will be done with the rifle on the cover, avoiding unnecessary exposure, the safety catch being left forward. The soldier must count the number of rounds fired so that he will know when to load with a further five rounds. The order to "Advance", "Watch the front" or "Take cover" may now be given, when the safety catch will be applied.

3. Practise squad.
4. i. Explain:-

In action, the enemy may only expose themselves for a very short space of time. It follows that the soldier must be trained to fire quickly as well as accurately. This type of firing is exactly the same as slow in principle, but the time for aiming must be

reduced to a minimum, and the general handling of the rifle speeded up.

iii. Explain and demonstrate (in firing position, with squad on right side):-

On the order "Rapid fire", fire as quickly as possible, consistent with accuracy. Quick reloading is essential. Continue firing until the enemy disappears or the order "Stop" is given.

5. Practise squad.

LESSON 8:- OTHER POSITIONS

Instructor's Notes

Stores:-

Suitable targets for each man and instructor.

Safety precautions (see General Notes for Instructors).

Give order "load" (see Chapter 3, Sec. 8). Squad on right side of cover.

This lesson should be taught behind varying types of cover, such as walls, trenches, windows, etc. The order of teaching is immaterial, i.e. standing may be taught first.

1. Revise Lesson 7, para. 1.

2. Explain and demonstrate:-

i. When high cover is met with, the firer will have to alter his position to suit it, so that he can fire accurately at the enemy. The methods of handling and firing the rifle are exactly the same as taught in Lesson 7. The positions which can be adopted will be shown in this lesson.

ii. *Kneeling and sitting:-* "Positions of observation" "Behind cover" and "Watch the front" will be carried out in exactly the same way as in Lesson 7, except the positions must be modified to suit the cover. The main point is to avoid over exposure. On the "Range" being ordered, or, if acting individually, set the sights to the estimated range and adopt the "Position of readiness". Kneel on the right knee, keeping it out to the right, and with the body supported on the right heel, the left elbow resting on the left thigh, if possible. It may be more comfortable to kneel on both knees or even adopt a sitting position, depending on the nature of the cover (*see Fig. 11*).

iii. *Firing:-* The resting of the rifle, firing, loading, etc., is exactly the same as already taught.

3. Practise squad in all methods of firing.

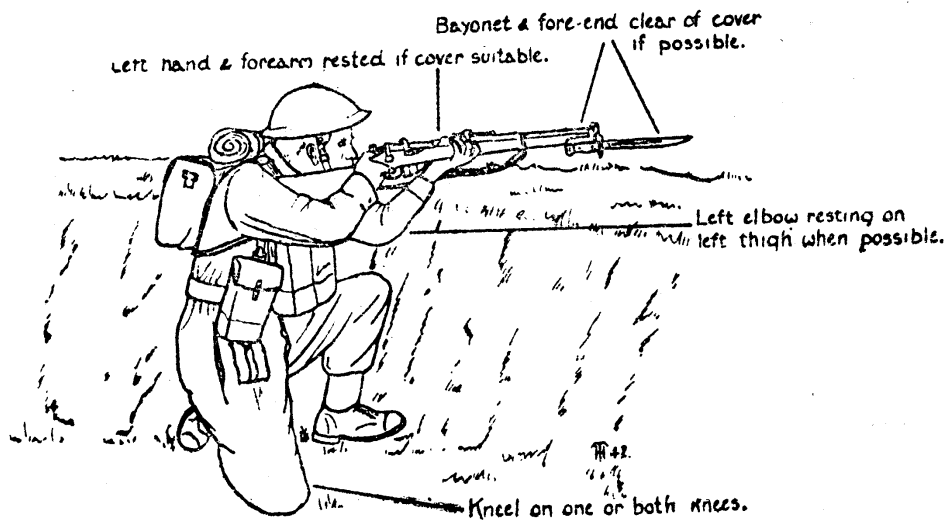

Fig. 11

4. *Standing:-*

- i. *Explain and demonstrate:-* “Positions of observation” and “Behind cover” and the actions of “Watch the front” are the same as for kneeling. Position of Readiness as for kneeling with probably slight differences such as both elbows rested, as in a trench. The body pressed against the cover if possible (*see* Fig. 12).
- ii. *Firing:-* The methods of firing, etc., are the same as already taught.

5. Practise squad.

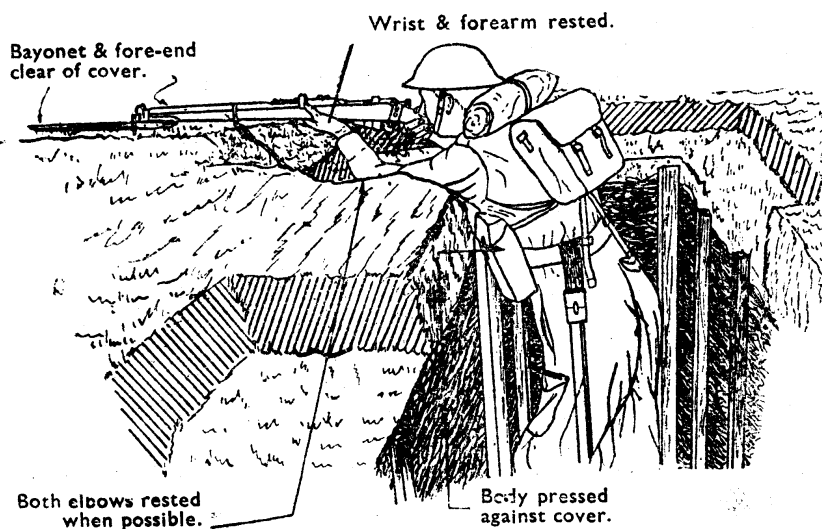

Fig. 12

6. Firing round cover

- i. Explain and demonstrate:-

Firing round cover generally entails less exposure than firing over cover. Give examples such as trees, rocks, etc. When firing round cover the right side is normally used.

- ii. On the command "Down" act as already taught. On the range being ordered, set sights and bring rifle forward to the right side of cover, adopting the "Position of Readiness", either standing, kneeling or lying according to the cover. Butt to be in the most convenient position. When lying behind isolated cover, the feet must be together to avoid unnecessary exposure (*see* Fig. 13).

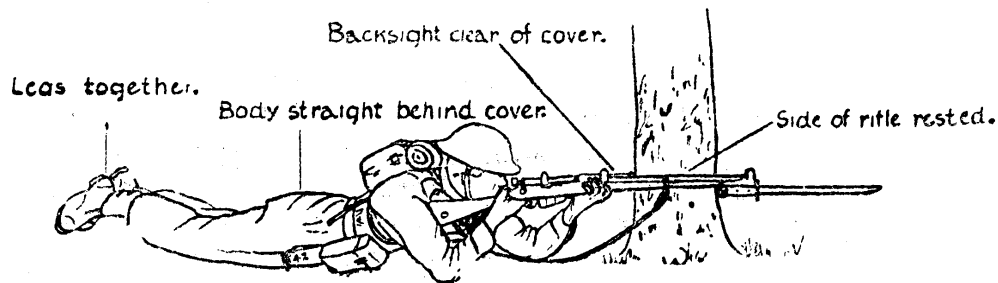

Side View.

(a) Side view.

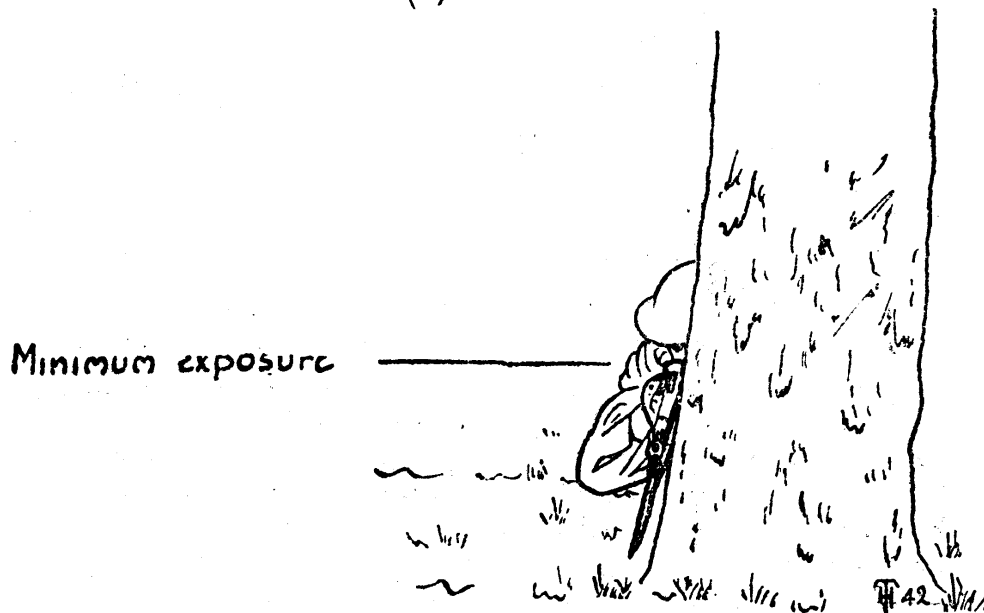

(b) Front view.

Fig. 13

- iii. *Firing*:- If the butt is on the ground, bring the rifle to the aim on the target being indicated. The left side of the rifle will be rested against the side of the cover with the backsight clear. Methods of firing as already taught, except that to avoid undue strain the butt need not be kept in the shoulder between shots.
7. Practise squad.
 8.
 - i. Explain:-

Occasions may arise when it is necessary to fire in the open. In this case the positions are the same as those already taught, but the rifle cannot be rested.
 - ii. Explain and demonstrate from the trail or slung position, firing in the open:-

When ordered, adopt a firing position quickly, hold the rifle firmly in both hands and bring the butt into the shoulder and aim. On the order "Fire", act as already taught.
 9. Practise squad firing a few rounds in each position.

LESSON 9:- FIRING AT MOVING TARGETS

Instructor's Notes

Stores:-

Aim corrector, one aiming rest.

Safety precautions (see General Notes for Instructors).

Two or three fatiguesmen, who must be rehearsed previously.

In para. 7 of lesson they move across the front of the squad at distances up to 300 yards, appearing from behind one piece of cover and disappearing behind another. After a pause of about five seconds they adopt a firing position for a few seconds in the place where they disappeared. They then withdraw and repeat. (When demonstrating from an aiming rest the rifle must be placed further forward than the normal in the rest, so that a correct grip may be obtained.) This lesson should be taught using cover if possible. Give the command "Load" (see Chapter III, Sec. 8).

1. Explain:-

As a general rule rifle fire will seldom be effective against individual men beyond 300 yards or against single vehicles beyond 500 yards.

A.F.Vs. must be engaged with small arms fire because it causes the visors to be closed and thereby hinders the crew. Further, while visors are still open a chance bullet, or small molten fragments from bullets hitting the armour near by may enter.

2. Riflemen must endeavour to shoot their enemy before they can get to cover. If this is not possible, the spot where they take cover must be marked so that they can be engaged quickly with accuracy on reappearing.

3. Crossing targets

Rules (see Fig. 14).

- i. Aim off at man walking - 1 man's width. (Fig. 14a.)
Aim off at man running - 2 men's widths.
Aim off at vehicles - 1 vehicle's width. (Fig. 14b.)
- ii. Swing rifle with target and fire without checking swing.

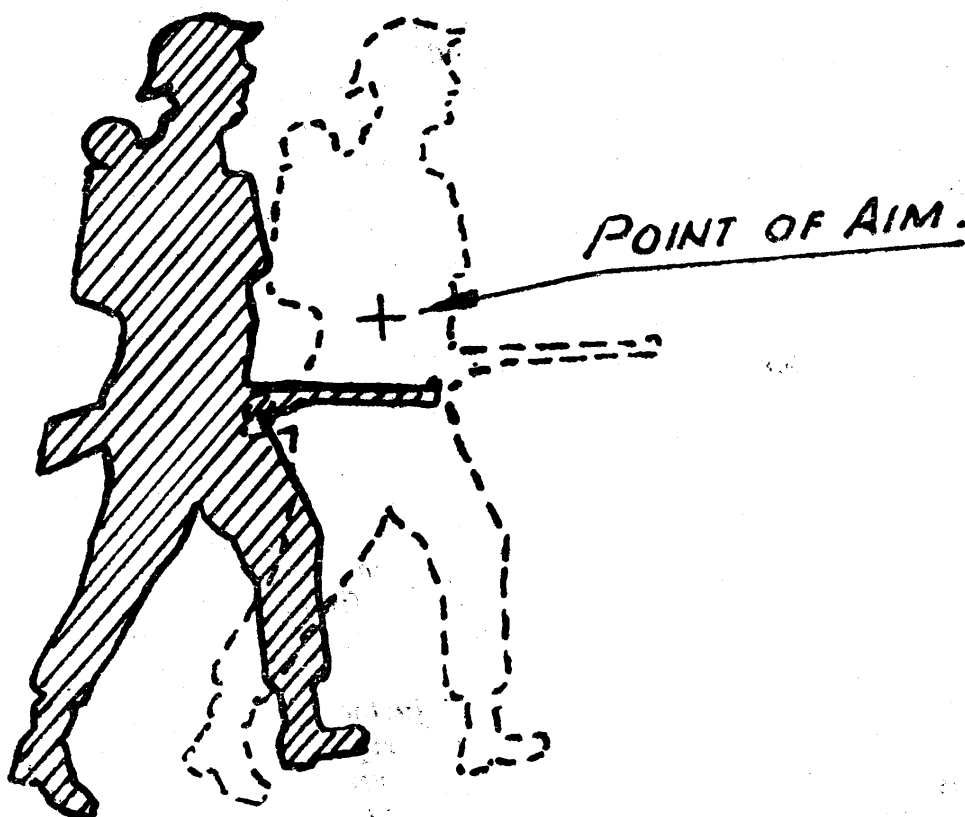

Fig. 14a

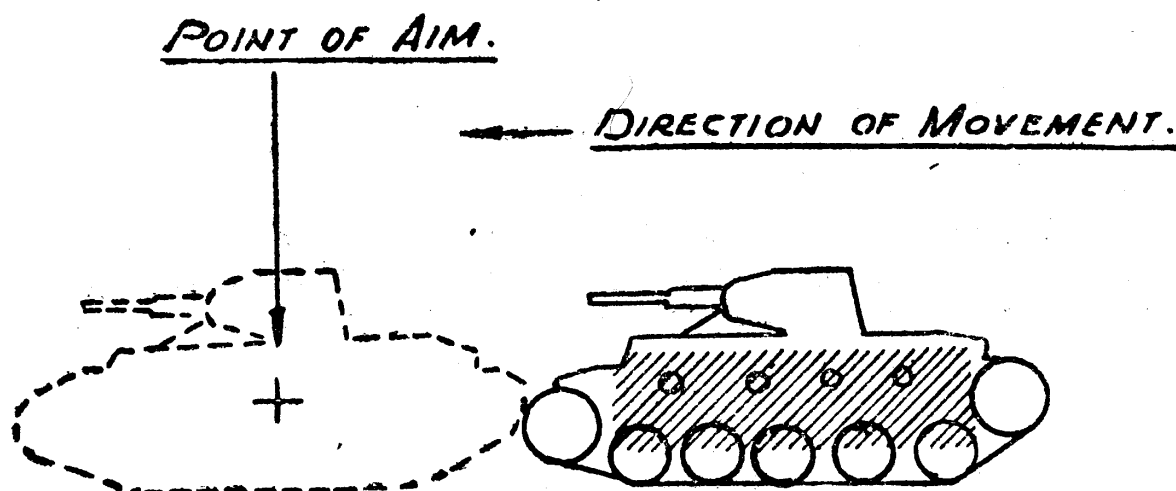

Fig. 14b

4. Demonstrate to each man through aim corrector, using aiming rest (if available), emphasizing continuous swing which must not be checked as trigger is pressed.
5. Practise squad at 100 yards and 200 yards. Check with aim corrector.
6. **Aiming at ground**

Rule:- Note the spot where enemy has disappeared and aim just below; on reappearance of target aim and fire.

7. Practise squad firing at men walking to cover at 200 yards. Squad should fire at least one shot at fatigued man in movement, and one when he reappears. Instructor checks with aim corrector. Repeat as time permits with fatigued man moving at the double up to 300 yards. Aiming off at vehicles should be practised, using any available traffic.

CHAPTER IV:- QUICKENING AND STRENGTHENING EXERCISES

1. These provide a means of quickening men in handling the rifle, and also of strengthening those muscles used in holding and firing it.
2. They should be carried out for the last few minutes of firing lessons whenever possible. They are also suitable for the daily weapon training period with trained soldiers.
3. The instructor should use his own discretion in framing these exercises; some suitable ones are given as a guide.

4. The men should be told the object of quickening and strengthening exercises (as in para. 1) and a spirit of competition introduced. Except for recruits, bayonets will normally be fixed.

5. Quickening exercises

- i. *Quick loading and reloading*:- Orders by instructor:-
“On the command ‘Go’ see who is the first man under cover and loaded with ten rounds – ‘Go’.”

“200 - Aim. On the order ‘reload’ open and close breech quickly and take first pressure again.”

Give order “reload” nine times followed by “load”.
- ii. Any variation to this exercise may be used at instructor’s discretion.

6. Strengthening exercises

Note:- These should be carried out in the open without the use of cover in order to obtain the maximum benefit.

- i. *Gripping*:- Practise squad in holding rifle in the shoulder with one hand in any firing position. Instructor gives orders to get squad into a firing position and then gives order “right hand off” - “change hands” - repeat as necessary. To finish, “both hands on” - “unload”.
- ii. *Quick lift*:- Instructor gives the command “load” followed by a sight adjustment. On the command “up” the squad bring their rifles quickly into the shoulder, take the first pressure and roughly align the sights on a suitable target, then lowering their rifles to the ground. The commands “up” and “down” may both be given if necessary to speed up movements.

CHAPTER V:- TESTS OF ELEMENTARY TRAINING

General

There are four tests. Of these, certain must be carried out by testing one man at a time; others may be carried out collectively and this should be done whenever possible. Particular attention will be paid to the correct firing positions before each test is begun.

No. 1. Aiming

This test is carried out using aiming rests. Three aims will be laid at a Fig.4a target at 200 yards. The aim will be

considered correct if it is approximate to the centre of the target.

Standard:- 2 aims correct out of 3.

No. 2. Aiming off

Carried out using aiming rests. Men will be ordered to aim off one target's width right or left of a Fig. 3 target at 300 yards. The aim will be considered correct if it is approximate to the centre of the auxiliary.

Standard:- 2 aims correct out of 3.

No. 3. Rapid firing

This test will be carried out using cover. The firer will be in the "Position of readiness". On the command "Rapid fire" he will fire at an aiming disc held to the instructor's eye. The command "Stop" will be given after 5 rounds have been fired.

Standard:- 4 out of 5 shots correct.

Time - 20 seconds from the command "Fire".

Bayonets fixed.

Drill cartridges will NOT be used.

No. 4. Firing positions

Bayonets fixed; inspection in positions behind suitable cover. Those who make serious faults will fail.

Note:- Faults which would reduce accuracy of fire and cause unnecessary exposure to view should be considered serious.

APPENDIX I

CARE OF NO. 2 RIFLE, .22-INCH

(For the information of weapon training instructors and men in charge of miniature ranges only.)

To preserve the high standard of accuracy necessary for training, by avoiding damage to the bore, the following instructions will be strictly obeyed:-

1. One individual will be given charge of the rifles.
2. An armourer or instructor will inspect the rifles periodically.

Ammunition, Mark I N.R.

3. Mark I N.R. ammunition leaves a deposit in the bore which protects it and prevents rust. This deposit must not be

removed by cleaning or oiling the bore, except for inspection by an armourer or for examination to discover suspected inaccuracy from lead fouling. After such an inspection, the bore will be oiled until the rifle is again required for shooting, when it will be dried out in the ordinary way. The protective deposit is replaced by firing, and further cleaning is unnecessary.

Before Mk I. N.R. ammunition is taken into general use, the bore must be cleaned by the method given below. No protection to the bore will be afforded if fouling from other ammunition is present.

- i. Pour four pints of clean boiling water through the bore.
- ii. Dry the bore immediately with flannelette until the patches come out clean.
- iii. Oil the bore with a 3/8-inch strip of flannelette, and dry it out before taking the rifle into use.

All types of ammunition other than Mk I. N.R.

4. When types of ammunition other than Mk I. N.R. are used, rifles will be cleaned as follows:-

- i. Fix the rifle in a vice or wooden holder.
- ii. Insert the cleaning rod from the breech end (bolt removed), to prevent bell mouthing of the muzzle.
- iii. Make sure that the rod, brush and cleaner are free from dust and grit and are not bent. Carelessness in this will damage the bore.
- iv. Clean the bore after firing 60 rounds (not oftener) with the rod and cleaner with a strip of flannelette 1/2 inch wide in the eye.
- v. After firing is finished for the day, clean the bore first with rod and brush, and then with the cleaner and flannelette, replacing the flannelette until it comes out clean. Oil the bore with a 3/8-inch strip of flannelette.
- vi. Dry the bore before firing begins again.
- vii. Clean the brush frequently in paraffin to free it from fouling.

APPENDIX II

The No. 3 Rifle

Variations to note in teaching the No. 3 rifle (pattern '14).

Lesson 1

Removal and replacement of bolt different. Removal of magazine platform different

Lesson 2

Examination of rifle has to be modified, i.e. examine ejector - examination of backsight differs.

Lesson 3

Include battlesight (up to 400 yards) in adjustment of sights (para. 1). When adjusted, leaf up.

Rule of aiming is:-

Look through the aperture at the target and align the top of the foresight on the centre of the target, keeping the aim central in the aperture with the sights upright.

Lesson 4

Diagram showing maintenance of elevation not practical in para. 2.

Lesson 5

Magazine holds 5 rounds only. Bolt will not go forward when magazine is empty. Alternative method of unloading not practicable. No need to draw rifle back to adjust sights.

Lesson 6

No half cock. Trigger cannot be pressed when bolt lever is not fully down. When not using drill cartridges a magazine depressor or halfpenny in magazine must be used.

Lesson 9

When demonstrating from aiming rest and when practising squad the aim corrector must be put well back on the butt.

APPENDIX III

**VARIATIONS TO NOTE IN TEACHING THE
No. 4 RIFLE**

Note:- The first issue of the No. 4 rifle will have a tangent aperture backsight, together with an aperture battlesight for use up to 300 yards with the bayonet fixed. Subsequent issues will have a battlesight as described in this appendix.

Lesson 1:- Number of rifle is on left side of body, not right front of it. There is no cut-off to this rifle. Removal and replacement of bolt different. (First issues of these rifles will have a retaining spring; later ones will not.)

Lesson 3:- Para. 1 *delete and substitute:-*

Explain that the backsight consists of a dual aperture battlesight, one marked 300 and the other 600. The one

marked 300 is accurate at 300 yards with the bayonet fixed, and at 400 yards without the bayonet. The one marked 600 is accurate at 600 yards without the bayonet. Adjust the sight in any convenient manner.

Para. 2. Rules of aiming:- See Appendix II as for No. 3 rifle.

Para. 3. Elevation:- Rifles - one 300 sight - one 600 sight.

Para. 4. Not applicable.

Lesson 4:- Aiming off the target

- i. Add to Instructor's Notes:-

(It must be clearly explained to men that the effect of removing the bayonet is to throw the shots higher. This is the opposite effect to the No. 1 rifle. This will be approximately 1 foot at 200 and 300 yards.)

- ii. Para. 2 of Lesson (maintaining elevation) - No diagram practical.

- iii. After teaching Lesson 4, paras. 1, 2, 3, *substitute* the following for paras. 4 and 5 of Lesson:-

4. Explain:-

It is only possible to make two alterations in sight adjustment - 300 or 600 yards. The rifle is, therefore, accurately sighted as follows:-

- i. Using the 300 sight - at 300 yards when the bayonet is fixed.
- ii. Using the 300 sight - at 400 yards without the bayonet.
- iii. Using the 600 sight - at 600 yards without the bayonet.

5. The general rule is, therefore, as follows:-

- i. *At ranges up to 300 yards*
The bayonet will be fixed, and the trajectory of the bullet is sufficiently flat for accurate shooting at service targets. The regulation aim will be used with the 300 sight.
- ii. *At ranges of approximately 400 yards*
The bayonet will not be fixed, and the regulation aim will be used with the 300 sight.
- iii. *At ranges beyond 400 and up to 600 yards*
The 600 sight will be used, and it will be necessary to aim down about 2½ feet at 500 yards.

Point out that it may be necessary to aim down to the amount of 1 figure's height on any type of target and at all ranges up to 500 yards. This is to counter errors in

elevation. One figure's height is a quick guide and will have to be used with commonsense.

Set simple problems to ensure the correct use of sights and to include aiming down. Check as in Lesson 4, No. 1 rifle.

Lesson 5:- No need to draw rifle back to adjust sights.

APPENDIX IV

THE No. 3 SNIPER RIFLE

The No. 3 rifle can be adapted to take either a pattern '18 or Aldis telescope and used as a sniper's rifle as follows:-

P.'18 telescope (differences in Aldis are shown in parentheses).

1. Method of focusing

- i. Loosen clamping screw.
- ii. Hold telescope steady - look through as in using ordinary telescope - with eye about 2 or 3 inches away - should have a full field of view.
- iii. Move focusing slide backward or forward until a clear view is obtained (Aldis - slide moves in diagonal slot).
- iv. Tighten clamping screw.
- v. Take care to keep slide in the same position when tightening up clamping screw.

2. How to attach telescope to rifle (Aldis telescope is permanently attached)

- i. See that fixing lever on left of rifle body is to the rear.
- ii. Place the two hooks under trunnions.
- iii. Drop rear end into rectangular slot on left of body.
- iv. Turn lever over to front to engage.

3. Method of loading with telescope attached

- i. Chargers cannot be used unless telescope is removed.
- ii. Load with 5 rounds singly. (Aldis - 'scope is off-set - charger loading can be used.)

4. Adjustment of sight

- i. Explain markings and figures on range scale.
- ii. Loosen range drum clamping screw

- iii. Turn range drum with thumb and forefinger until line required on range scale is opposite reference mark on saddle.
- iv. Tighten clamping screw.

5. Method of aiming

- i. Use aiming and head rests.
- ii. Illustrate with large diagram.
- iii. Sights upright. Cross wire a good guide when actually aiming.
- iv. Close disengaged eye.
- v. Eye about 2 to 3 inches away. A full field of view must be obtained. If floating aperture is visible, the eye is either too near or too far away from telescope.
- vi. Direct the top of pointer in the centre of the target. Centring of sight in aperture is automatic.

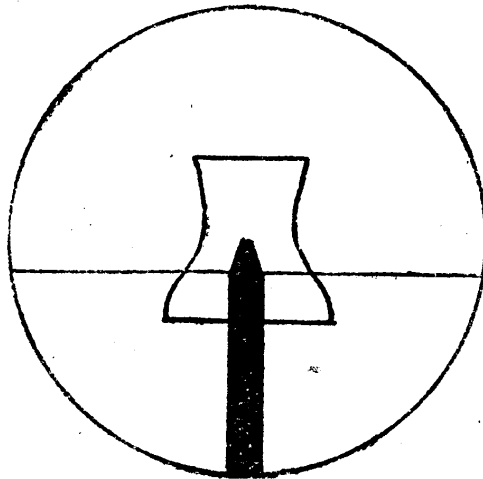

Fig. 15

ZEROING SNIPERS' RIFLES FITTED WITH THE '18 AND ALDIS TELESCOPIC SIGHTS

General considerations

1. Examination before test

The rifle and telescopic sight must be examined by the armourer before test, to ensure that all screws are tight, and that the rifle is stocked up correctly, free from "nickeling" and oil

2. Weather conditions

Good shooting light, and the calmest available weather conditions must be chosen. Sight will be set at 100 yards.

3. Range

100 yards from foresight to target.

4. Position

Lying. Forearm and wrist rested (not the rifle).

5. Targets

Any suitable target with a 2-inch black aiming mark. A vertical line to be drawn through the centre of the mark, and another line – $\frac{7}{8}$ inch to the right of centre. (This line is for the Aldis.)

6. Point of aim

Lowest central point of the aiming mark.

7. Method

Two shots will be fired into the bank to warm the barrel. A group of five rounds will be fired. The necessary standard of grouping is 3 inches at 100 yards.

8. After any adjustment has been made, the rifle should be re-tested and corrected as necessary, as the figures given are approximations, but if used as a guide will save time and ammunition.

Note:- No vertical or lateral error should ever be left on a sniper's rifle.

THE '18 TELESCOPIC SIGHT

1. The M.P.I. using the '18 telescopic sight should be as follows:-
At 100 yards, the point of aim.

2. To adjust errors

i. *For deflection*

Remove telescope from rifle.

Remove ray shade.

Slacken the three screws fixing the prism cell.

With adjusting key turn cell containing prism as required, viz:-

If the group has formed on the right of the centre line, turn the cell clockwise, if to the left, anticlockwise. By turning the cell the prism is also turned, which, being wedge shaped, bends the ray of light. The sight itself is not moved.

One division in the adapter gives approximately 5 inches for each 100 yards.

Example:-

Rifle is shooting 5 inches right at 100 yards.
 Adapter is turned to the right (clockwise) one division. This bends the ray of light to the right. Thus when a fresh aim is taken, the barrel will be moved over to the left 5 inches.

Note:- When a lateral adjustment is made with the '18 telescopic sight the accuracy of the range scale for elevation should be checked, as it may happen that the elevation was altered during the lateral adjustment. In adjusting, therefore, it is important that the adjustment for lateral deflection should be made first, and the adjustment for elevation should be made later if necessary.

ii. *For elevation*

The range scale is graduated in hundreds of yards from 100 - 1,000.
 When firing at 100 yards alteration of the range drum will affect elevation as follows:-

From 100 - 200 yards and vice versa - 2 inches
 From 200 - 300 yards and vice versa - 3 inches
 From 300 - 400 yards and vice versa - 4 inches

And so on up to 1,000 yards.

3. Example "A"

The group fired at 100 yards formed 5 inches low.

The following procedure will be carried out:-

- i. Unclamp the range drum clamping screw.
- ii. Set sight at 300 yards (2+3=5 inches) and re-tighten the range drum clamping screw.
- iii. Fire another group.
- iv. If the group is correct for elevation do not loosen the range drum clamping screw, but loosen the small twin screws securing the washer in the centre of the range scale ring.
- v. Turn range scale ring until the scale is set to 100 yards.
- vi. Tighten up the twin screws.

4. Example "B"

The group fired at 100 yards formed 9 inches high.

In this case proceed as follows

- i. See that the range drum clamping screw is securely tightened.

- ii. Calculate the distance on the range scale which will give the required drop on the target, i.e. from 100 - 400 yards (2+3+4=9 inches).
- iii. Loosen the twin screws securing the washer in the centre of the range scale ring.
- iv. Turn the range scale clockwise until the reading shows 400 yards.
- v. Tighten up the twin screws.
- vi. Loosen the range drum clamping screw and turn the range drum anti-clockwise until it reads 100 yards.
- vii. Re-tighten the range drum clamping screw.
- viii. Fire another group and, if error has not been completely corrected, repeat the procedure.

THE ALDIS OFFSET TELESCOPIC SIGHT

1. General

- i. The range scale is graduated in hundreds of yards from 100-600.
- ii. The M.P.I., using the Aldis offset telescopic sight, should be as follows:-
At 100 yards 7/8-inch right of point of aim.
- iii. The general considerations for zeroing this sight are contained in Sec. 1 of this Appendix.

2. To adjust errors

- i. *For deflection*
 - (a) Slacken the large screw which secures the rear bracket to the rifle.
 - (b) Slacken the large screw on the left side of the bracket.
 - (c) Turn the small adjusting screw, which is behind the large screw on the left side of the bracket, to the right if the group has formed right. This will bring the rear of the telescopic sight to the left. Thus to aim afresh the barrel will be brought to the left. If the group has formed left, turn the adjusting screw to the left. This will bring the rear of the telescopic sight to the right (when the large side screw is tightened) so that the barrel is brought to the right.
 - (d) Tighten the large side screw.
 - (e) Tighten the large top screw.

Note:- A quarter turn of the adjusting screw will give an approximate deflection of 4 inches at 100 yards.

ii. *For elevation*

There are three range scale adjusting screws on the side of the range drum. One of them may be hidden by the saddle. When a screw is so hidden, loosen the range drum clamping screw, turn the range drum until the screw is visible, loosen it, then re-set the range drum and follow the same procedure as for the '18 telescopic sight. When zeroing is completed, re-tighten the hidden screw.

Note:- The range scale ring is prevented from turning too far in either direction by a stop on the range scale ring and a screw behind the rear saddle. It is inadvisable to loosen this screw.

APPENDIX V

THE No. 4 SNIPER RIFLE.

(Rifle No. 4, Mark 1* (T) fitted with No. 32 Telescopic Sight.)

1. **General:-** The No. 4 rifle can be fitted with the No. 32 telescopic sight for use as a sniper's rifle, in which case it is issued in a chest S.A. No. 15 together with the items listed below, as a complete equipment. The rifle is fitted with a special sling, a cheek rest and two pads to take the telescopic sight. In the chest is also packed the telescopic sight in a metal case with a leather carrying strap, complete with bracket, leather protecting caps, an adjusting tool, and a polishing cloth. This cloth must only be used for cleaning the lenses and must be kept clean. Telescopic sights are paired with rifles and are NOT interchangeable. The magnification of the telescope is 3.
2. **Focusing:-** It is neither necessary nor possible to alter the focus of the telescopic sight.
3. **To attach telescope to rifle:-** Remove telescope from its box by unscrewing the large-headed clamping screws and attach to the pads on the rifle, partially tightening the rear clamping screw first and finally screwing both fully home.
4. **Adjustment of sight:-** The telescope is graduated for elevation from 0 to 1,000 yards, and can be adjusted in 50 yard clicks by turning the range drum until the required range is opposite the pointer mark.

Lateral adjustment is also possible by turning the deflection drum on the left of the telescope. This drum is graduated in minutes of angle in two minute clicks up to 16 minutes each side of zero. (A minute of angle equals approximately one inch on the target for every 100 yards of range.)

Example:- If, when firing at 300 yards, a shot is observed to strike 1 foot to the left of the mark, turn the deflection drum anti-clockwise 2 clicks = 4 minutes = 12 inches.

5. Method of aiming:- As for '18 or Aldis telescopes, *see* page 33.

6. Zeroing

i. *General considerations*, as for '18 and Aldis telescopes, *see* page 33.

ii. *To adjust errors*

(a) First alter setting of range and/or deflection drums so as to bring the M.P.I. to coincide with the point of aim.

Note:- If the shots are striking to the left of the point of aim turn the deflection drum anti-clockwise ; if to the right, turn the drum clockwise.

(b) *Elevation* is adjusted by placing the adjusting tool over the range drum so that the slot on the end of the upper tommy bar and the projections on the base of the lower tommy bar engage with the projection on the central pin and in the slots in the clamp ring respectively.

Loosen the clamp ring by turning the lower tommy bar one-half turn anti-clockwise at the same time holding both the upper tommy bar and the range drum stationary.

Still holding the upper tommy bar stationary, rotate the range drum until the range to the target is shown opposite the pointer mark.

Holding the upper tommy bar and the range drums stationary, tighten the clamp ring by turning the lower tommy bar in a clockwise direction. An assistant to hold the range drum will facilitate adjustments.

(c) *Deflection* errors are eliminated by following the above procedure with the deflection drum, moving the drum until the figure 0 is opposite the pointer mark.

APPENDIX VI

THE SNIPER SLING**General description**

The sling consists briefly of two parts. (A and B as shown in Fig. 16.) Part A is longer than Part B and is attached to the upper sling swivel and forms the principal part. Part B is much shorter, is fixed to the lower sling swivel and is connected with A by a metal link, so enabling the rifle to be slung.

The object of the sling

- i. To assist shooting by keeping the rifle steady, when cover is not available.
- ii. To enable the rifle to be carried on the shoulder in the normal manner.

How to fit to rifle

Take the larger Part A, which forms the upper part and do as follows:-

- i. Slide the sling keeper (leather band) down to within about 9 inches from the sling hooks, place the plain end through the link attached to Part B till it touches the keeper, bend the sling round and slide it once more back through the keeper, thus forming a leather loop for the metal link attached to B.
- ii. Slip the second keeper over the plain end of the sling and place this end through the upper sling swivel, double over and bring back through the second keeper and engage first pair of holes with the hooks.
- iii. Place Part B through the lower sling swivel, and engage hooks with holes so that sling hangs sufficiently loose to enable rifle to be carried slung on the shoulder.

How to use the sling

- i. Loosen the lower loop of the sling so that it hangs free as shown in Fig. 18.
- ii. Insert the left arm through the upper loop from right to left. (To facilitate doing this, the sling should be given a half turn in an anti-clockwise direction.) Hoist the upper loop well up the arm so that it is near the shoulder and well above the biceps muscle (Fig. 19).
- iii. Pull the keeper (Fig. 20) close against the arm to keep the upper loop in place.

- iv. Move the left hand over the top of the sling and grasp the rifle near the top sling swivel so as to cause the sling to lie smoothly along the back of the hand and wrist (Fig. 21).

The lower loop, not used in shooting, should be so loose as to prevent any pull upon it.

Neither end of the sling will be removed from either swivel.

Having carried out the above and assumed the lying position, when in the aim the sling should be just sufficiently tight to offer support, but not so tight as to have a tendency to pull the left elbow to the left or to prevent proper circulation of the blood in upper portion of the left arm.

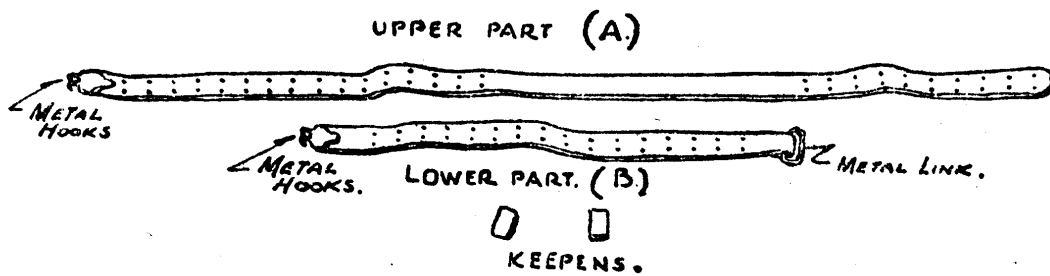

Fig. 16

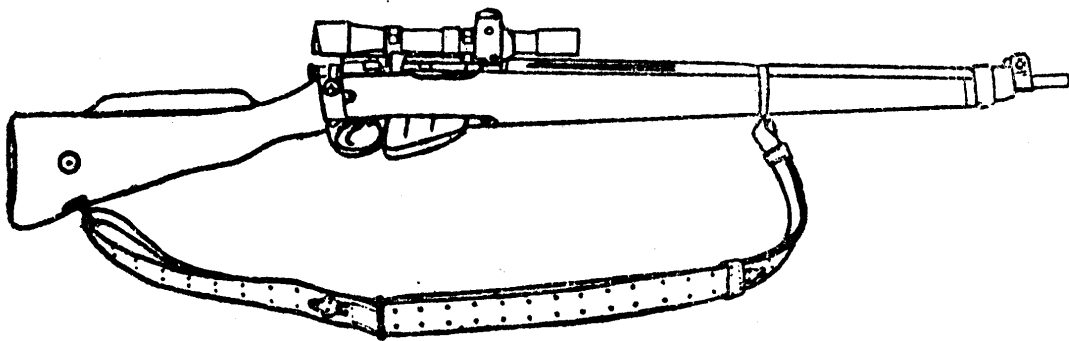

Fig. 17

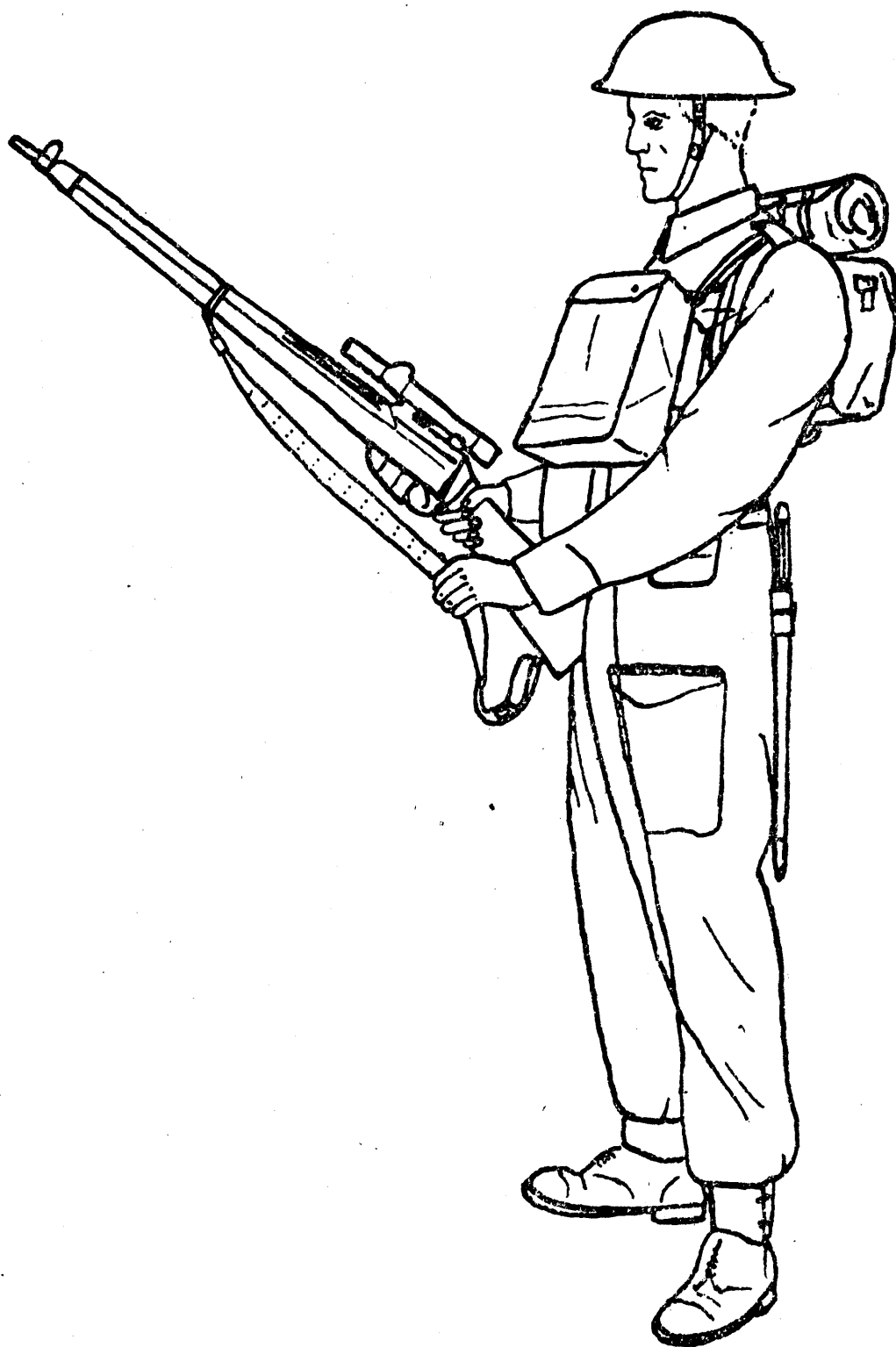

Fig. 18

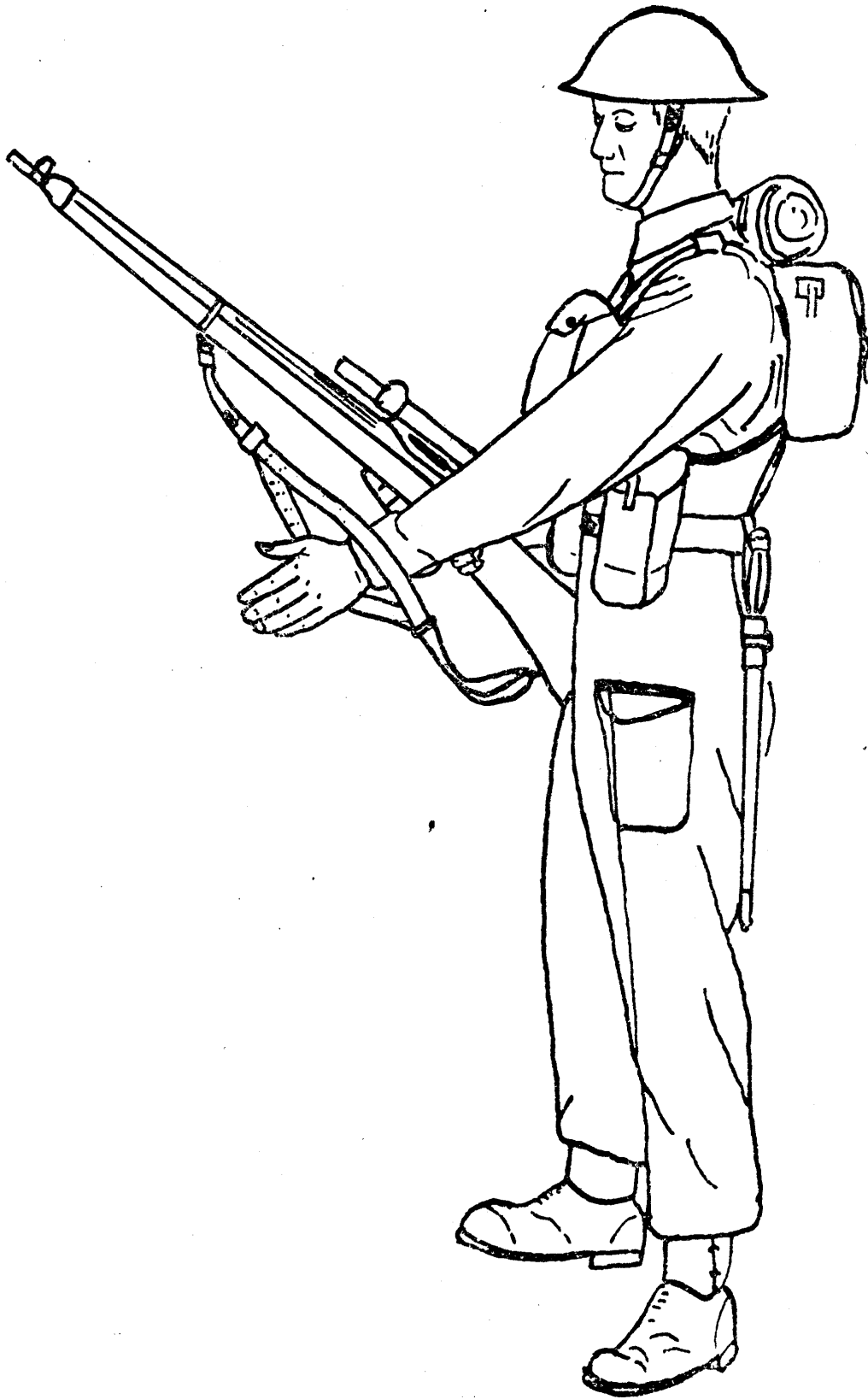

Fig. 19

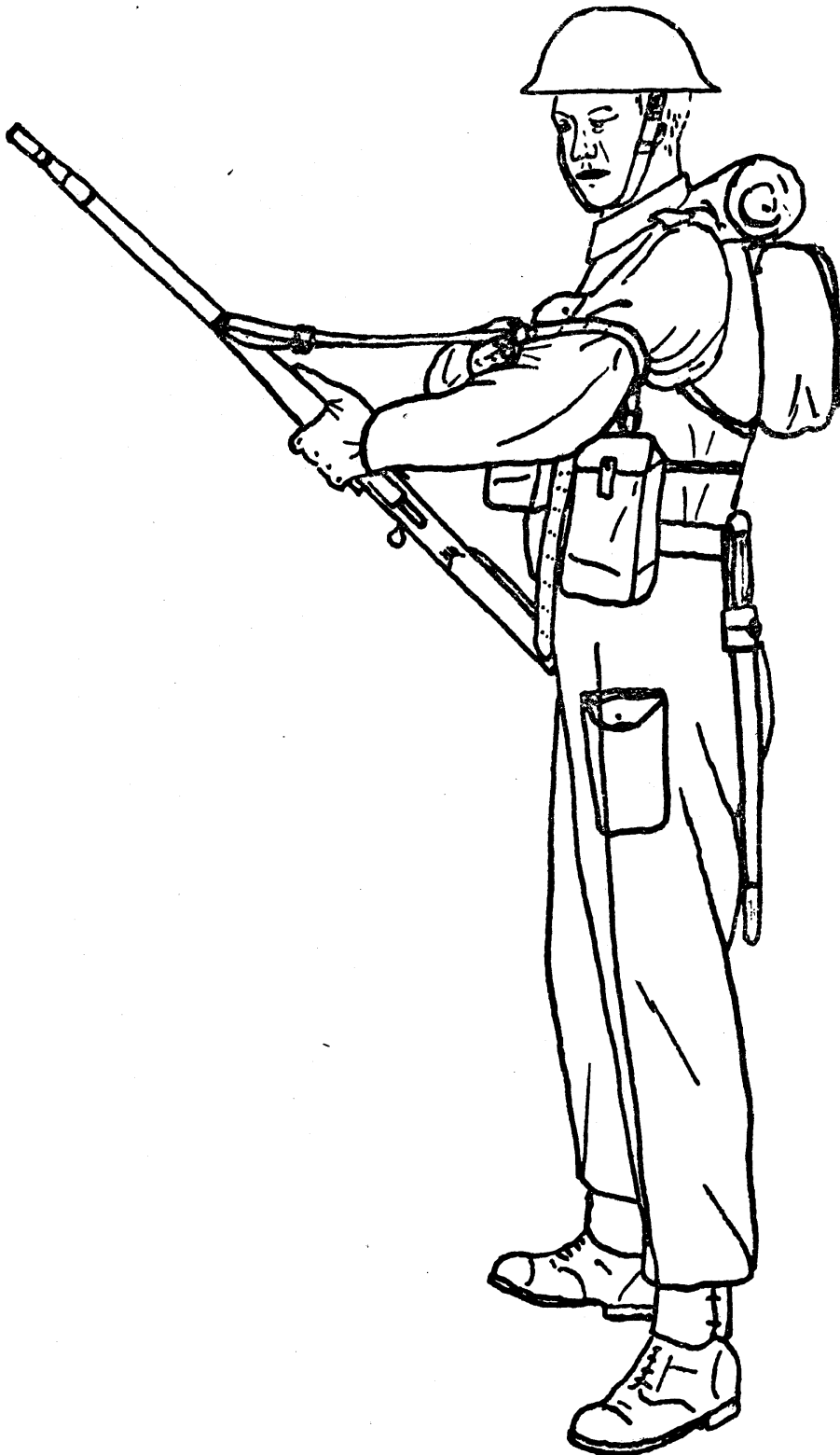

Fig. 20



Fig. 21