

PETTY OFFICER J. B. HOWARD,

SMALL ARMS MANUAL

Rifles, Machine Guns, Machine Carbines,
Revolvers, Pistols

By **BRIGADIER J. A. BARLOW, S.A.C.**
The West Yorkshire Regt.

Late Technical Officer, Machine Gun School.
Assistant Supt., Design Department. Deputy
Supt., Small Arms Experimental Estabt.

and

LT.-COL. R. E. W. JOHNSON
The London Rifle Brigade

WITH MANY
ILLUSTRATIONS

2/- net

LONDON
JOHN MURRAY, ALBEMARLE STREET, W.1.



Production is restricted so don't blame your dealer if you have difficulty in obtaining Gillette blades.

Gillette is called up. No more deferments for the Blue and Thin Gillette or 7 o'clock blades. As stocks run out they must get into battledress as Gillette "Standard" Blades, but they'll still give you the finest shave you can buy.

Gillette in battledress

Gillette "Standard" and "Standard Thin" Blades (plain steel)
2d each, including Purchase Tax. Fit all Gillette razors, old or new

SMALL ARMS MANUAL

By BRIGADIER J. A. BARLOW, S.A.C.
The West Yorkshire Regt.

Late Technical Officer, Machine Gun School.
Assistant Supt., Design Department. Deputy
Supt., Small Arms Experimental Establt.

and

LT.-COL. R. E. W. JOHNSON
The London Rifle Brigade

WITH MANY ILLUSTRATIONS

Revised Edition

LONDON

JOHN MURRAY, ALBEMARLE STREET, W.

www.vickersmachinegun.org.uk

First Edition	January 1942
Reprinted	February 1942
Reprinted	June 1942
Second Edition	November 1942
Reprinted	July 1943
Third Edition	February 1944

Uniform with this Book

HOME GUARD TRAINING MANUAL

By MAJOR J. LANGDON-DAVIES, M.B.E.

Illustrated with diagrams, 25.

Revised and enlarged edition.

FIELD CRAFT TRAINING MANUAL FOR HOME GUARDS

By MAJOR J. LANGDON-DAVIES, M.B.E.

Illustrated with diagrams and photographs, 25.

Printed in Great Britain by Wyman & Sons, Ltd., London, Fakenham & Reading

CONTENTS

CHAPTER	PAGE
INTRODUCTION	6
I. RIFLES	11-55
1. .303-inch Short Magazine Lee-Enfield (Rifle No. 1)	11
2. .303-inch Pattern '14 (Rifle No. 3)	16
3. .303-inch Rifle No. 4	23
4. .303-inch Canadian Ross	28
5. .300-inch U.S.A. Model '17	34
6. .300-inch U.S.A. Springfield	36
7. .300-inch U.S.A. Garand Self-loading	38A
8. .30-inch Self-loading Carbine M.1 (U.S.A.)	38H
9. .303-inch Sniping Rifle No. 3 Mk. 1* (T)	39
10. .303-inch Sniping Rifle No. 3 Mk. 1* (T) A	44
11. .303-inch Sniping Rifle No. 4 Mk. 1* (T)	45A
12. .300-inch U.S.A. Browning Auto Rifle	46
13. 7.92 mm. Mauser (Germany)	50
14. German 7.92 mm. self-loading Rifle (G.41 W)	51A
15. .256-inch Mannlicher-Carcano (Italy)	52
16. .55-inch Boys' Anti-tank Rifle	54
II. LIGHT MACHINE-GUNS	56-129
1. .303-inch Bren	56
2. .303-inch (British) and .300-inch (U.S.A.) Lewis	67
3. .303-inch Hotchkiss	82
4. .303-inch Vickers-Berthier (India)	91
5. 7.92 mm. M.G. 15 (Germany)	99
6. 7.92 mm. M.G. 34 (Germany)	106
7. 7.92 mm. German M.G. 42	110A
8. 6.5 mm. and 7.35 mm. Breda (Italy)	111
9. 8 mm. Madsen (Denmark)	116

CONTENTS

CHAPTER	PAGE
III. MEDIUM MACHINE-GUNS	130-161
1. .303-inch Vickers	131
2. .30-inch Browning (U.S.A.)	149
3. .256-inch Revelli (Italy)	157
4. 8 mm. Fiat-Revelli (Italy)	159
5. .315-inch Schwarzloze (Austria)	160
IV. MACHINE CARBINES	162-184
1. .45-inch Thompson	162
2. 9 mm. Sten	168
3. 9 mm. Solothurn (Germany)	173
4. 9 mm. Schmeisser (Germany)	176
5. 9 mm. Parachute Troops Carbine (Schmeisser type) (Germany)	179
6. 9 mm. Bergmann (Germany)	182
7. 9 mm. Beretta (Italian)	184
V. REVOLVERS AND AUTOMATIC PISTOLS	185-222
1. .455-inch Webley Revolver	186
2. .380-inch Pistol No. 2	191
3. .455, .45 and .38-inch Colt Revolvers	194
4. .450 and .455 Colt Automatic Pistols	199
5. .38 Colt Automatic Pistol	204
6. .380 Colt Automatic Pistol	206
7. .455, .38 and .45 D.A. Smith and Wesson Revolvers	209
8. 9 mm. Borchardt-Luger (Germany)	214
9. 9 mm. Mauser (Germany)	218
10. 9 mm. Walther (Germany)	223
11. 9 mm. Beretta (Italian)	227

PREFACE

The purpose of this little book is explained in the Introduction. The lay-out, as far as possible, is the same for each weapon.

In describing the parts of the various weapons, I have followed the principle that it is better to use terms which

(i) Denote the work which the parts do, and

(ii) Are, therefore, readily understandable,

rather than to adhere strictly to Service nomenclature.

The latter frequently does not convey to the uninitiated the function of the part to which reference is being made.

For this reason, although every effort has been made to do so, Service names have not always been used, e.g. Pistol No. 2., the part which retains the cylinder in position I have referred to as the "cylinder retainer," although the correct Service designation is "cylinder cam".

In addition, when referring to a particular part I have tried to indicate, by the name, exactly what the article mentioned does, e.g. "pawl pin operating pawl lever," refers to the pin on the pawl which actuates the pawl lever.

Lastly, although in all weapons I have set out briefly how to strip and assemble, I want to issue a word of warning with regard to the stripping of revolvers. These weapons should not normally be stripped. It is possible, however, that you might find two damaged pistols of the same type and be able to make a complete whole out of the damaged parts. It is for this reason that I have detailed the stripping and assembling for these weapons. Some of them are a little difficult unless one has a fair idea of how to set about the job.

INTRODUCTION

Large numbers of various types and kinds of small-arm weapons are in use in the present war by the Royal Navy, the Army, the Royal Air Force, and the Home Guard. These consist of our own standard and reserve patterns of Rifles, Machine-guns, Light Machine-guns, Machine-carbines, and Pistols, together with many different varieties and calibres of similar weapons from the U.S.A.

It may fall to the lot of anyone in any of the services in battle to require to know how to use any particular one of the various weapons with which he may possibly come in contact. It must be remembered that the man on service may also have the opportunity of employing captured weapons against the enemy. This adds to the extent of the knowledge necessary for the man in the services who desires to make himself an efficient "man-at-arms".

This little book, therefore, has been produced with the intention of summarizing the main items of requisite knowledge about each of the following weapons:

- (i) Our own small arm weapons.
- (ii) U.S.A. small-arm weapons procured by Great Britain, and
- (iii) Similar enemy weapons of which sufficient information is available.

The service man possessing only an elementary knowledge of any particular rifle or light machine-gun should, from the information contained herein, be able to utilize any of the other types in battle.

The facts given may be summarized as follows:

- (i) Brief particulars for identification, etc.
- (ii) How to load, fire, and unload automatic weapons only.
- (iii) Stoppages and immediate action in the case of automatic weapons.
- (iv) Brief mechanism in certain cases where it helps to understand immediate action.

INTRODUCTION

7

- (v) Stripping and assembly as far as is necessary for maintenance in battle, and cleaning thereafter.
- (vi) Certain particulars with regard to ammunition where available.
- (vii) Any particulars of interest.

In addition to the mechanical information given in the body of the book it appears desirable to touch briefly, in this introduction, on the rôles for which the various types of weapons are designed in order to clear away any misconceptions which may arise as to their comparative efficiency. For example, in the case of rifles the extreme range is very much greater than the maximum *accurate* range, whilst with the Medium Machine-Gun the difference between the extreme range and the maximum accurate range is far smaller.

Brief notes on the functions in battle of the weapons are therefore given below.

The Rifle.

This is the personal weapon of the great majority of soldiers. It is often alluded to, and rightly so, as the "soldier's best friend," and if properly cared for and handled is a powerful weapon of offence or defence at all ranges from point blank to at least 600 yards. Between 600 and about 1,000 yards only a skilled marksman can be expected to hit individual men, although in countries where the atmosphere is clear and visibility is exceptionally good hits have been recorded at distances up to one mile.

At ranges up to about 400 yards the trajectory of the bullet is so flat that a man who knows his rifle should have no difficulty in hitting his opponent, using the battle sight (where provided) without having to aim down more than a very few inches at any distance.

The principle of "lengthening the bayonet" by firing from the hip during an assault with the bayonet should not be forgotten, but practice will be necessary to acquire

accuracy with this method as there is a very marked tendency to shoot high.

Although the greater number of L.M.G.s now issued have to some extent minimised the necessity for accurate rapid fire, the ability to produce such fire is still a most valuable attribute of the rifle, particularly in the case of the No. 1 (S.M.L.E.) and No. 4 rifles, both of which have the famous Lee bolt action. Soldiers armed with either of these should have no difficulty in attaining, with practice, a speed of anything up to twenty aimed shots in one minute, whilst those armed with the No. 3 (P. 14) or the U.S.A. Model 1917 should be able to reach fifteen rounds a minute.

Ability to fire quickly at a fleeting target (i.e. Snap-shooting) should also be encouraged. To be able to bring the rifle into the shoulder and the sights into instant alignment, combined with the ability to get the shot away accurately and at once in any circumstances, will give the soldier a very marked advantage over a less skilled opponent.

The Light Machine-Gun.

This weapon is the main armament of the Infantry section and its fire will normally be controlled by the section commander. Although the man who carries and fires it may have no other arms it cannot be strictly regarded as a "personal" weapon since any man in the section may be called upon to use it at a moment's notice, and since it is not as handy as a rifle, on account of its greater weight, for use at close quarters or on the move.

Its weight, however, coupled with the fact that it is normally supported at the forward end by a bipod (i.e. not solely supported by the firer) make it reasonably accurate at distances greater than could be achieved with the rifle, although it uses the same ammunition. The average man can expect to produce fire effect with the modern L.M.G. at ranges up to 800 or 1,000 yards, depending on visibility,

and the expert may be able to "deliver the goods" at even greater ranges.

With some L.M.G.s it is possible to fire either single shots or bursts; with others bursts only are possible. Bursts should be of about four or five rounds.

If it is possible to fire the weapon from a tripod mounting accurate fire can be brought to bear on suitable targets such as bridges and defiles at ranges up to 1,500 yards or more. At any range in excess of 600 yards fire will normally be in bursts and not in single shots.

The Medium Machine-Gun.

Since this weapon is normally mounted on a heavy tripod its accuracy can be relied upon at ranges considerably greater than those attained by the L.M.G. or the rifle. In the case of the Vickers gun this increase in accurate range is enhanced by the fact that special (Mark VIII) ammunition is used which makes it possible to employ the gun in a miniature artillery rôle at ranges up to 4,500 yards.

The medium machine-gun should, therefore, not be wasted on short-range tasks which can be undertaken with L.M.G.s. (or, even by riflemen), but should be used on targets at ranges in excess of 1,000 yards. Fire should be in bursts of not less than 20 rounds, the length of burst increasing with the ranges up to about 30 rounds.

The Machine Carbine.

Next to the rifle as a personal weapon comes the "Tommy gun," and used intelligently it is a very fine weapon for either offence or defence, but it has a grave limitation in the fact that its accuracy deteriorates rapidly at ranges greater than about 100 to 150 yards. This is on account of the small charge behind the bullet—with a consequent low muzzle velocity—and the short barrel. The machine carbine is basically a weapon of opportunity and cannot take

the place of the L.M.G. or even the rifle except at very short ranges where its handiness and capability of producing a good volume of fire quickly make it eminently suitable for patrols and street fighting.

This weapon must not be regarded as a "bullet-spray"; economy of ammunition must constantly be emphasized. The correct way to use it is to fire the shortest burst which will achieve the desired result, and to strive to make every shot tell.

The Pistol.

Revolvers and Automatic Pistols are essentially personal weapons and their main rôle should be defence rather than attack, although its value as a weapon of offence in the hands of a determined and experienced man must not be under-rated. Whilst experts can do considerable damage with such weapons at ranges of about 50 yards the average user will not have much success even on a life-size figure target at any range of much more than as many feet. Moreover, to achieve anything like accuracy, combined with the speed which will usually be essential, considerable practice will be necessary. This also applies very forcibly to any attempt to shoot from the hip with the pistol, which should be strongly discouraged on the ground that it inevitably results in waste of ammunition, until the firer is reasonably proficient in the more normal position with the arm raised.

Notes on 9 mm. Ammunition

Weapons dealt with in this book take three different types of 9 mm. ammunition. The easiest means of identification is by measurement of the overall length of case and bullet, i.e. overall length of the cartridge as a whole. These are as follows:

Type.	Overall length of cartridge.
1. Parabellum.	Varies from 1.14 to 1.16 inches.
2. Mauser.	Approx. 1.37 inches.
3. Italian ("corto") short type.	Approx. 1.0 inch.

CHAPTER I

RIFLES

Preliminary Note.

Any man in any of the regular services or in the Home Guard will know how to use at least one rifle, i.e. the type with which he or his unit is armed. All rifles are very much alike in essentials, although they all have certain individual peculiarities. Therefore little additional knowledge is required to be able to utilize any other type which may be encountered.

This chapter will therefore merely furnish:

- Brief particulars of each rifle;
- Information as to how to remove and replace bolt and magazine;
- Description of mechanical safety device, if any; and
- Any special features of the particular rifle under review.

In view of the fact that removal and replacement of the bolt and magazine is really all that anyone need be able to do, no attempt has been made to cover detailed stripping. Such stripping is a matter for the armourer.

1. .303-INCH SHORT MAGAZINE LEE-ENFIELD (S.M.L.E.), Mks. III AND III*.

(a) Particulars.

Service designation.	Rifle No. 1 Mks. III and III*.
Weight.	8 lbs. 10½ ozs.
Weight with bayonet.	9 lbs. 11½ ozs.
Length with normal butt.	3 ft. 8½ ins.
Length with bayonet.	5 ft. 1½ ins.

Capacity of magazine.	10 rounds.
Charger or clip loading	Charger (5 rounds).
Type of sights.	Open. U notch and blade.
Range of adjustment.	200 to 2,000 yds.
Cut-off for magazine.	Mk. III—yes. Mk. III*— no.

(b) Removal and replacement of bolt and magazine.

(i) To remove bolt.

Push forward the safety-catch which will be found on the left side at the rear of the action. Raise the bolt-lever by pulling it up to the left, and pull the bolt back as far as it will come. Place your right thumb on the left of the bridge charger guide and hook the forefinger under bolt-head. Levering against the thumb, pull up the bolt-head. This action will release it from the spring retaining-catch. See that the bolt-head is in line with the bolt-way in the rear of the body, and withdraw bolt.

* *Note.* Before attempting to lever up the bolt-head over its retaining catch make sure that the bolt is fully to the rear.

(ii) To replace bolt.

All bolts are numbered to coincide with the number of the rifle to which they belong. Make sure that you are putting back the correct bolt before you start. A wrong bolt, which will most probably fit badly, gives inaccurate shooting.

Reverse the process outlined in (i) above, but before doing so make sure:

- That the bolt-head is fully screwed home;
- That the cocking-piece is in line with the lug on the underside of the bolt; and

(e) That, before forcing the bolt-head down over the spring retaining-catch, the bolt is pulled back to the fullest extent, i.e. until the bolt-head is touching the resistance shoulder on the top right rear of the body.

(iii) To remove magazine.

Push in, or pull up, the magazine-catch which is just in front of the trigger. Remove the magazine.

(iv) To replace magazine.

Push the magazine into the magazine opening with the narrower end first and pointing forwards. Snap home and test that the magazine-catch is properly engaged by trying to pull the magazine out.

(v) To remove magazine platform and spring for cleaning.

Hold the magazine in your right hand, platform uppermost. Push the rear of the magazine platform down into the magazine casing with the thumb of the left hand, and ease the front of the platform up behind the two lips of the magazine. Withdraw platform and spring.

(vi) To replace magazine platform and spring.

Insert spring in casing. Push down rear of platform and lever under the two rear lips of the magazine. Continue the downward pressure until you can lever the front of the platform under the two front lips. Relax pressure and the platform will rise into place. If it does not do so, give a slight push downwards on the front end of the platform. This will rectify the jam which will have been caused by the platform binding against the forward internal ribs of the magazine casing.

(c) Applied and mechanical safety devices.**(i) Applied safety.**

Safety-catch on the left rear side of the action. When pushed forward, it is out of action. In this condition the bolt can be operated and the rifle fired. When pulled fully back to the rear, the locking-bolt of the safety-catch protrudes into the short cam slot at the rear of the bolt, thus preventing rotation of the bolt. At the same time the half-moon lug of the safety-catch engages in one of two recesses in the cocking-piece, thus stopping forward or rearward movement of the latter. When in the fired position, the rear recess is engaged; in the cocked position the forward recess is utilised.

(ii) Mechanical safety.

If the bolt is not correctly closed when the trigger is released, one of two things will happen, viz. either:

- (a) The bolt will be forced into the closed position by the cocking-piece going forwards, or
- (b) The action will go into *half-cock*.

The half-cock position is brought about as follows: With the bolt so far from being closed that it will not respond as in (a) above, the stud on the cocking-piece jams behind the stud which lies between the long and short cam grooves on the bolt. On releasing the trigger the sear rises, and on pushing down the bolt-lever the cocking-piece is freed from interference with the stud on the bolt, flying forward under the influence of the striker spring until it is again held up, this time by the engagement of its half-bent with the sear. The half-bent being undercut, the trigger is locked; at the same time the stud on the cocking-piece is now in the long cam groove in the bolt and lying immediately alongside the stud dividing the short and long grooves, and therefore the bolt-lever cannot be rotated and the action opened.

To remedy when the bolt goes into *half-cock*, pull back the cocking-piece by hand to full-cock. No other action is possible.

(d) Special features.

The locking-lugs on the Lee-Enfield action are at the rear of the bolt. One lug bears against the resistance shoulder on the right of the body, while the other rides up, and bears against, the rear wall of a cam slot on the left side of the body.

This system of locking has both advantages and disadvantages. From the rough wear and tear service point of view, the former outweigh the latter. The main disadvantage is that super-accuracy is difficult to obtain since the bolt and the major portion of the body is in a state of compression when the shot is fired. Accuracy, however, is sufficiently good from the service point of view, with the sole exception of sniping. This drawback is amply compensated for by the following advantages:

- (i) Simple, sweet, and easy bolt action which is admirable for rapid fire. There is no abrupt turn over of the bolt-lever such as is necessitated by front locking-lugs.
- (ii) Able to function well in adverse conditions of sand, dust, mud, etc.
- (iii) Easy to clean, owing to the absence of forward locking recesses in the body.

This action is quite the best in the world for ordinary rough wear and tear of service conditions.

2. .303-INCH PATTERN '14. (P.14.)

(a) Particulars.

Service designation.	Rifle No. 3 Mk. 1*.
Weight.	9 lbs. 6 ozs.
Weight with bayonet.	10 lbs. 7 ozs.
Length.	3 ft. 10½ ins.
Length with bayonet.	5 ft. 3¼ ins.
Capacity of magazine.	5 rounds.
Charger or clip loading.	Charger (5 rounds).
Type of sights.	Aperture.
Range of adjustment.	200 to 1,650 yds. There is also a battle sight (aperture) sighted for 400 yds.

Cut-off for magazine. Nil.

(See Fig. 1, p. 17).

(b) Removal and replacement of the bolt and magazine.

(i) To remove the bolt.

Push forward the safety-catch which will be found on the right-hand side at the rear of the body behind the bolt lever. Raise the bolt-lever upwards to the left and pull the bolt to the rear. With the left thumb push out the bolt retaining catch on the left of the body to the left and withdraw the bolt.

(ii) To replace the bolt.

Before attempting to replace, ensure

- That the tooth on the front end of the cocking-piece is engaged in the short groove on the end of the bolt, and
- That the extractor is in direct line with the solid lug on the right of the bolt.



Rifle No. 4, Mk. I.

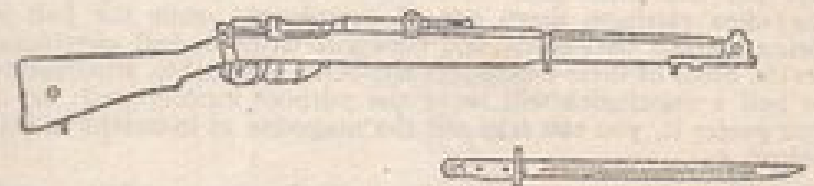

Rifle No. 1, Mk. III

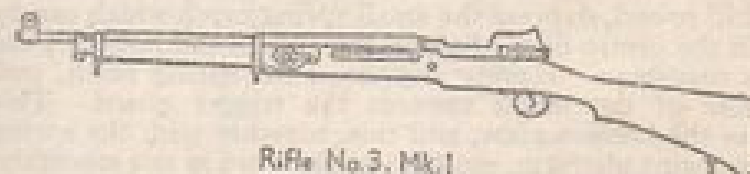

Rifle No. 3, Mk. I

and
U.S.A. Model '17

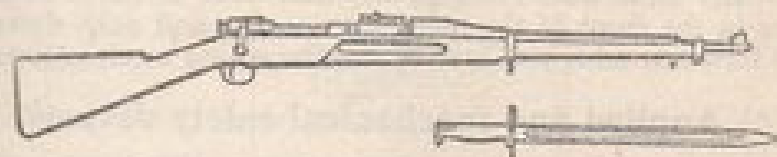

U.S.A. Springfield Model '03.

FIG. 1.

Insert the bolt in the rifle, depress the magazine platform with the thumb of the left hand, and ease the bolt home.

Note. The interference of the magazine platform is arranged deliberately to act as an indication that the magazine is empty.

For rapid-fire training, when learning to manipulate the bolt quickly, a magazine-platform depressor is issuable on a scale of one per five rifles held on charge. This depressor keeps the magazine platform down out of engagement while the bolt is being worked backwards and forwards without drill cartridges. In the event of these depressors not being obtainable, a halfpenny or half a matchstick will serve the purpose equally well; or, if you prefer it, you can take out the magazine as indicated in (iii) below.

(iii) To remove magazine platform, spring, and bottom plate.

Turn the rifle upside down, and with the nose of a bullet or a drill round, depress the small spring catch which can be seen in the centre of the hole in the rear of the bottom plate of the magazine. Having depressed the spring catch, pull the nose of the bullet towards the trigger guard. This releases the bottom plate, and this, together with the spring and magazine platform, can then be removed as one assembly.

(iv) To replace magazine platform, spring, and bottom plate.

Insert the complete assembly in the magazine opening from the underside. Engage the front end of the bottom plate in the front of the magazine opening and push down and forwards until you hear or feel the spring catch engage.

(c) Applied and mechanical safety devices.

(i) Applied safety.

Safety-catch on the right side behind the bolt-lever. When pushed forward, it is out of action and the rifle can be fired and the bolt operated. When pulled to the rear the

safety-catch comes into operation. It acts in much the same manner as the catch on the Rifle No. 1.

(ii) Mechanical safety.

When the rifle is loaded and the bolt-lever is fully down,

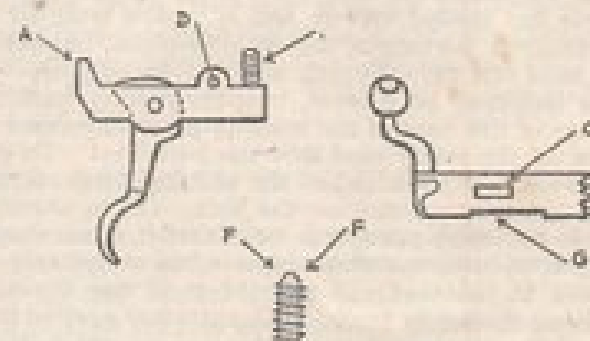
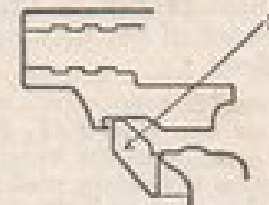

RIFLE No. 3.

MECHANICAL SAFETY.

FIG. 2.

the sear A (Fig. 2.) is engaged in the bent of the cocking-piece. Meanwhile the safety-stud B is underneath the small cut-away slot C in the under side of the bolt. On the trigger being pressed the nose of the sear is depressed.

Since the whole sear is hinged on the sear axis pin D, the safety-stud E is compelled to rise. It is only able to do so by fitting into the slot C. The mechanical safety device, therefore, is that if the bolt-lever is not fully down, the safety-stud is unable to rise on the trigger being pressed. Consequently the sear-nose cannot be depressed sufficiently to disengage from the bent of the cocking-piece, and therefore the rifle cannot be fired.

Note. The safety stud is rounded off on either side (looked at from either the front or rear—see F, F, Fig. 2) to allow the bolt to be rotated for the opening of the breech after each round has been fired. At that time the safety stud is not protruding fully, but merely just appearing in the bolt-way. This is due to the fact that the sear has been allowed to rise, since the bent on the cocking-piece has passed over it, and it is now situated half-way along the cut-away portion of the cocking-piece, i.e. between the rear of the bent and the stripping nib. (E in sketch).

Thus the bolt may be rotated, but, on pulling back the bolt-lever, the rear of the bent of the cocking-piece depresses the sear. This pushes up the safety stud into the bolt-way. To permit of this rising of the safety stud when the bolt has been rotated, there has to be a cut-away portion on the bolt. (G in sketch). The length of this cut-away portion is such that it accommodates the raised safety stud until the cocking-piece has completely travelled over the nose of the sear and allowed it to rise again, thus in turn depressing the safety stud. The cut-away portion is roughly the length of the portion of the cocking-piece which has caused the sear to be depressed. The cut-away is rounded off fore and aft.

(d) Special features and general information of interest.

The locking-lugs on this rifle, and indeed the whole design of the bolt and trigger mechanism, very closely follow the normal Mauser type. The lugs are at the front end of the bolt, and they engage in recesses in the front of

the body just behind the rear end of the barrel. These locking recesses are not easy to keep clean. The advantages and disadvantages of this type of action are almost exactly the reverse of those appertaining to the S.M.L.E. (or Rifle No. 1).

Owing to the fact that the Mauser type action lends itself to a higher standard of accuracy, the Pattern '14 rifle, when suitably fitted with telescopic sight, is issued and used as a sniping rifle. When so fitted the rifles are known as:

- (i) Rifle No. 3 Mk. I* (T), or
- (ii) Rifle No. 3 Mk. I* (T) A.

These are dealt with later in this chapter.

Some P. '14 rifles are fitted with a fine adjustment back-sight. These were used for sniping purposes in the last war before the telescopic sight came into production. They are denoted by the suffix (F) instead of (T). (F—fine adjustment; T—telescopic). There is nothing else special about the (F) rifles.

SOME GENERAL NOTES ON THE P. '14.

This rifle is a conversion from a design of a .276-inch calibre weapon which was under consideration for the re-arming of the Forces prior to the war of 1914-18. A change of calibre on the outbreak of that war—necessitating a complete change over in the factories, not only those concerned in the new rifle, but also those involved with its ammunition—was out of the question.

The supply of large numbers of the S.M.L.E. for the arming of the troops, and for replacements, became so insistent that the small arm factories in the British Isles could not cope with the demand. This caused us to go to the U.S.A. as an additional source of supply. Manufacturers there were unable to promise to produce in any large quantity the complicated S.M.L.E.—complicated only from the point of view that it had not been designed or laid out for

mass production. They, however, promised to proceed with the newly-designed rifle in a .303-inch calibre. Accordingly orders were placed with three firms, but a little latitude had to be given, resulting in the fact that interchangeability of some of the components suffered.

These slight discrepancies caused the rifle to be issued under three different sub-divisions, distinguished from one another by the following identification marks:

Position of Mark	Manufactured by—		
	Remington Arms Co.	Remington Arms Union	Winchester Repeating Arms Co.
On right top front of body	E.R.A.	R.E.	W.
On right side of butt	I.E.	I.R.	I.W.
On principal components	e.	r.	w.

N.B. You will notice that there is a common identifying letter in each case, i.e., E, R, or W.

Later it was found necessary, owing to the cartridges on rising from the magazine, and going forward, not engaging or being engaged by, the left lug, to modify the bolt by lengthening that component. This necessitated deepening the recess on the rear barrel face to receive the longer lug. Rifles having had their barrels so altered are stamped Mk. I*; should the bolt be of the later pattern it is marked with a "star" on the lever.

Note. Unless the barrel has been modified, the "star" bolt will not function with it. It is unlikely that you will encounter any unmodified rifles or bolts in these days. All rifles should by now be Mk. I*.

3. .303-INCH RIFLE No. 4.

(a) Particulars.

Service designation.	Rifle No. 4 Mk. I.
Weight.	9 lbs. 3 ozs.
Weight with bayonet.	9 lbs. 10 ozs.
Length with normal butt.	3 ft. 8½ ins.
Length with bayonet.	4 ft. 5 ins. (approx.).
Capacity of magazine.	10 rounds.
Charger or clip loading.	Charger (5 rounds).
Type of sights.	Aperture and blade.
Range of adjustment.	Early models, 200-1,300 yds. Production models, 100-600 yds.
Cut-off.	Early models—Yes. Production models—No.

N.B. The bayonet is of a new pattern, or rather a resuscitation of an old type. It is a spike bayonet of comparatively short length, about 8 ins. long. This makes for lightness and handiness which more than make up for what is lost in length of reach. (See Fig. 1, p. 17.)

General description.

This rifle differs very little from the S.M.L.E., of which it is a modern copy. In fact when it was first produced it was known as the S.M.L.E. Mk. VI.

The S.M.L.E., as it is generally known, is not designed in any way for modern mass production, having been born many years before such things were thought of. The Rifle No. 4 was designed purely from the point of view of mass production. The number of different types of steel and of difficult machining operations has been reduced to a minimum. At the same time certain improvements have been incorporated. These are:

- (i) The lighter and shorter and more easily manufactured bayonet.
- (ii) Slightly heavier and sturdier barrel, which makes for greater accuracy.
- (iii) Improved stocking up arrangements, including a better form of nose cap, which also helps to give greater accuracy.
- (iv) A machined surface for the bolt-head to ride upon inside the body.
- (v) A smaller and more compact bolt-head (permitted by (iv) above).
- (vi) A new type of bolt retaining arrangement.
- (vii) An aperture instead of an open sight. This again improves accuracy.
- (viii) The bayonet is fitted by means of a turning lock. This also is a reversion to a design of a century or more ago.

A few thousand rifles were made up for troop trials round about 1930-31. These proving satisfactory, the design was approved and laid aside for use in emergency, since financial stringency prevented any more positive action being taken at that time. Since the outbreak of the present war a few further modifications to the design have taken place in order to assist manufacture. It is probable that substantial numbers of the later design will be manufactured in the near future. There will thus be two models in existence

(b) Removal and replacement of bolt and magazine.

(i) To remove bolt.

(a) EARLY MODELS. Open the bolt as for the S.M.L.E., but do not draw it right back. Depress the catch in front of the resistance shoulder and, while keeping it depressed,

draw back the bolt to the fullest extent. Leave go of the catch, push up the bolt-head, and withdraw the bolt.

(b) PRODUCTION MODELS. Raise the bolt-lever as for the S.M.L.E., but only draw back the bolt about half an inch until the gap in the bolt-head runner on the body coincides with the bolt-head itself. In this position lift up the bolt-head into the vertical position and withdraw the bolt.

(ii) To replace bolt.

(a) EARLY MODELS. See that the bolt-head is screwed home. Place the bolt in the bolt-way and push forward. Turn the bolt-head down, pressing it against the spring retaining-catch; at the same time push the bolt forward and home. The retaining-catch will rise behind the bolt-head as soon as the latter is clear.

(b) PRODUCTION MODELS. See that the bolt-head is screwed home. Place the bolt in the bolt-way and push forward. When the bolt-head is past the bridge charger guide, turn it over to the right until it rests on the runner on the body. Position the bolt-head over the cut-away portion of the runner and push down and forwards.

(iii) Removal and replacement of the magazine and magazine platform.

Identical with the S.M.L.E.

(c) Applied and mechanical safety devices.

Both the applied and mechanical safety are exactly the same as in the S.M.L.E.

(d) Special features and general information of interest.

These are tabulated, in this instance, in the general description under (a) above.

Advantage has been taken of the opportunity afforded by war production, in which time is a vital factor, to dispense with a certain number of peace-time frills. These are the modifications referred to in the general description under (a). The main modifications are:

- (i) Omission of $\left\{ \begin{array}{l} \text{cut-off.} \\ \text{piling swivel.} \\ \text{butt disc.} \end{array} \right.$
- (ii) Simplified design of foresight protector.
- (iii) Radically simplified backsight.
- (iv) Circular spike bayonet vice cruciform.
- (v) Further simplified bolt retaining arrangements.

A brief description of items (iii) and (v) above are as follows:

SIMPLIFIED BACKSIGHT.

This sight consists simply of two aperture battle sights set at right angles to one another. The shorter range one is calibrated for 300 yards when the bayonet is fixed and is correct for 400 yards when the bayonet is not fixed. The longer range one is correct for 600 yards—of course without the bayonet.

Presupposing that the normal practice of fixing bayonets when within 300 yards of the enemy is adhered to, the method of use is as follows:

- (i) At 300 yards use the 300 aperture with the bayonet fixed and take a normal aim.
- (ii) At 400 yards use the 300 aperture without the bayonet fixed and take a normal aim.
- (iii) At 600 yards use the 600 aperture (obviously without the bayonet fixed) and take a normal aim.
- (iv) Up to 300 yards aim down a little, using the 300 aperture. The maximum amount of "aim down" at any intermediate range does not exceed 8 inches.

- (v) At 500 yards or thereabouts use the 600 aperture and aim down. The amount of "aim down" at 500 yards is at the most $2\frac{1}{2}$ feet.

The above rules are very simple, and ensure that the man always keeps his target in view. They also obviate any possibility that a man will forget to alter his sights as the range alters. He has to use his head a little but all that he has to do, somewhere between 400 and 500 yards is to flip one sight down and the other comes up automatically.

SIMPLIFIED BOLT RETAINING ARRANGEMENTS.

These consist simply of the abolition of the bolt-head catch and the substitution for it of a small cut-away in the bolt-head runner in the body. The bolt-head will only come out of the body when it strictly coincides with this "cut-away."

4. .303-INCH CANADIAN ROSS RIFLE.

(a) Particulars.

Service designation.	Ross rifle .303-in. Mk. III B.
Weight.	9 lbs. 14 ozs.
Weight with bayonet.	11 lbs.
Length.	4 ft. 2½ ins.
Length with bayonet.	5 ft. 0½ ins.
Capacity of magazine.	5 rounds.
Charger or clip loading.	Charger.
Type of sights.	Aperture and semi-open.
Range of adjustment.	Aperture 200 to 1,200 yds. Battle sight (semi-open) 400 yds. Long-range sight (semi-open), 1,000 to 1,600 yds.
Cut-off for magazine.	Yes.

(See Fig. 3, p. 29.)

(b) Removal and replacement of bolt.

(1) To remove the bolt.

The safety-catch on this rifle is on the right side on the bolt-lever. It is a catch of the swing over type, on which is stamped on either side the words "READY" and "SAFE." Put the catch to the "READY" position.

On the left side of the body you will find a thumb-piece which can be turned, in the vertical plane, to three positions, i.e. "up", "centre", or "down". Place this thumb-piece in the centre position. This will permit the bolt to be withdrawn.

To withdraw the bolt, pull it straight to the rear by

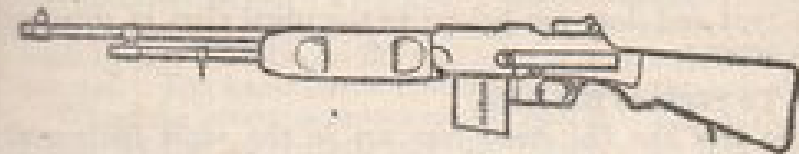

BROWNING LIGHT AUTO RIFLE



ROSS

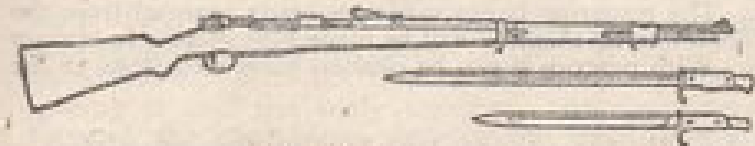

MAUSER

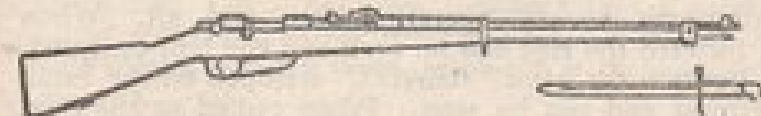

MANNLICHER CARCANO

FIG. 3.

means of the bolt-lever. The bolt action is of the straight pull type and does not belong to the usual class of rotating bolt actions.

(II) To replace the bolt.

See that the bolt-head lugs are in the same horizontal plane as the bolt-lever. In this position the main spring is compressed and the bolt-head proud of the sleeve by about an inch. It is possible for the bolt-head to spring back against the sleeve under the influence of the main spring. Hence the warning to see that the lugs are in the same horizontal plane as the bolt-lever, i.e. bolt extended and main spring compressed.

With the bolt in this condition insert into the rifle, seeing that the grooves on the bolt and the runners on the body coincide, and push home.

Thereafter put the thumb-piece on the left side to the top position.

Note. The magazine is not made for ready removal from the rifle. Therefore no mention will be made here of how to remove or strip. With practice it can be cleaned quite well when in the rifle.

(c) Applied and mechanical safety devices.

(I) Applied safety.

Safety-catch on the right side on the bolt-lever. It is of the swing-over variety operating fore and aft. When pushed forward the rifle can be fired and the bolt operated. In this position the word "READY" stamped on the catch is uppermost and can be seen. When pulled to the rear, the catch is in operation, the word "READY" is hidden underneath, and "SAFE" is visible.

(II) Mechanical safety.

The bolt consists of two main portions, the bolt proper

and the bolt sleeve. The part of the bolt which enters the bolt sleeve, and the part of the latter which receives the bolt, each have spiral ribs, on the rear ends of which screw threads are cut. The knob of the bolt is attached to the bolt sleeve.

When the action is unlocked, the bolt is linked to the bolt sleeve by the interrupted threads. During the first part of the forward movement of the bolt sleeve these are automatically unlocked from one another by the cam on the bolt-head coming into contact with the unlocking pin in the body. The bolt is then forced to rotate by the action of the spiral ribs on the bolt and bolt sleeve. The locking-lugs on the bolt rotate into locking recesses.

It is necessary to understand the above in order to appreciate the mechanical safety. This is as follows:

During the pressing of the trigger a pawl rises behind projections on the bolt sleeve and prevents any backward movement of the latter. Should the bolt not be properly closed: on pressing the trigger the sear is released from the bent; the main spring carries the firing-pin forward and the cocking-piece forces the sleeve in front of it; the spirals on the sleeve complete the turning movement of the bolt, thus locking it and the body together. As the sleeve travels forward the projections depress the pawl, and the latter rises behind the projections as the sleeve completes its forward movement.

Thus the energy of the main spring is expended in closing the action. It is probable therefore that a miss-fire will occur if the bolt is not properly closed. In any event the rifle cannot be fired until the action is correctly closed and locked.

(d) Special features and general notes on the Ross rifle.

As previously mentioned, this rifle is one of the very few straight pull bolt action types in the world.

When the thumb-piece on the left side is in the top position, feeding of rounds from the magazine is arranged; when in the down position, the backward movement of the bolt is restricted and no rounds are taken from the magazine. In this position, therefore, it acts as a cut-off, and the rifle becomes a single loader for the time being. As already mentioned, the centre position of the thumb-piece permits withdrawal of the bolt. In the other positions interference between bolt and thumb-piece acts as a bolt stop.

A strong word of warning is necessary in regard to mal-assembly of the bolt itself. Stripping should not be required, but it is possible that an over-enthusiastic individual may have done so and assembled it wrongly. The correctness or otherwise of the condition of the bolt can be determined by the following rules:

- (a) With the bolt in the rifle look at the distance between the rear of the bolt-head and the front end of the sleeve. If this distance is approximately one inch, the bolt is correctly assembled.
- (b) In the same circumstances, if the distance between the bolt-head and the sleeve is about a quarter of an inch or less, the bolt is wrongly assembled.

Never attempt to fire a rifle in this condition. If you do, the bolt may blow back out of the rifle and kill or maim you.

This rifle is a very accurate and excellent target rifle. Its complicated bolt, however, makes it very susceptible to interference from dust dirt, sand and mud. It is not therefore, a very good service rifle, both from this point of view and from the fact that it is rather long and, generally speaking, cumbersome. It was for these reasons that it was discarded by the Canadians, in favour of the S.M.L.E., during the war of 1914-18.

The sighting arrangements are as follows:

- (i) An aperture backsight from 0 to 1,200 yards—readings

by the initial figures of the range on the face of the sight as you look at it.

- (ii) On the right side is a fine adjustment scale in minutes of angle—each division represents 2 minutes. The figures therefore give 10 minute rises.
- (iii) A short-range battle sight of the semi-open variety is available when the leaf is down. This is correct for 400 yards with Mk. VII .303-inch ammunition.
- (iv) A long-range battle sight for use when the sight leaf is up. With the slide in the lowest position, i.e. line at zero, the range catered for by the semi-open sight cut-in the top of the slide is 1,000 yards.

As the slide moves up the leaf this long-range battle sight will give a range of whatever is provided by the position of the slide, plus 1°. (One degree is the elevation required for 1,000 yards.)

- (v) Lateral adjustment of the backsight is allowed for; each large division on the scale denoting 5 minutes of angle (i.e. 5 inches on the target for each 100 yards of range). Alterations of one minute of angle are made possible by the use of a vernier scale.

5. U.S.A. MODEL '17. .300-INCH.

(a) Particulars.

Service designation.	U.S. Model '17.
Weight.	Approximately the same as for the British .303-inch P. '14.
Weight with bayonet.	
Length.	
Length with bayonet.	5 rounds.
Capacity of magazine.	
Charger or clip loading.	Charger (small brass type).
Type of sights.	As for British P. '14.
Range of adjustment.	
Cut-off for magazine.	

(See Fig. 1, p. 17.)

(b) Removal and replacement of bolt and magazine, etc.

Exactly the same as for the British P. '14.

(c) Applied and mechanical safety devices.

Same as the P. '14.

(d) General information.

On her entry into the war of 1914-18, the U.S.A. had to arm a very large number of men in a limited space of time. Her service rifle was the Springfield .300-inch Model 1903. Having insufficient of these, she obviously had to augment supplies by increased production. She had been making for Great Britain the .303-inch P. '14. Just as the latter rifle had been converted from a .276-inch design (see page 21) so could it equally well be made to suit the U.S.A.

.300-inch cartridge, with, of course, the necessary adjustments.

This was an obviously sound line of action since the jigs and tools were mostly immediately available, and three manufacturers had had experience of production.

The resultant rifle was the Model '17. Here in England it is frequently mis-called the Springfield. I have even seen it so referred to in one of the many unofficial booklets on sale. The only feature which is common to this rifle and to the Springfield (dealt with on the next page) is that they both take the same ammunition!

6. U.S.A. SPRINGFIELD. .300-INCH.

(a) Particulars.

Service designation.	U.S. .300-inch Springfield. Model 1903.
Weight.	9 lbs. 11 ozs.
Weight with bayonet.	10 lbs. 11 ozs.
Length.	3 ft. 7½ ins.
Length with bayonet.	4 ft. 11 ins. (approx.).
Charger or clip loading.	Charger (small brass type).
Type of sights.	Aperture and open. (See below under (d).)
Range of adjustment.	100 to 2,850 yds.
Cut-off for magazine.	Yes. Same type as the Ross. (See Fig. 1, p. 17.)

(b) Removal and replacement of bolt and magazine.

(i) To remove bolt.

Place cut-off in centre position as for the Ross. Raise the bolt-lever and withdraw the bolt.

(ii) To replace bolt.

With the cut-off in the centre position, hold the rifle in the fingers of the left hand with the thumb extending over the left side of the body. Then, while pressing down the magazine platform with the thumb of the left hand, slide the bolt into the bolt-way in the body. Lower the bolt-lever, turn the safety-catch and cut-off down to the left, and pull the trigger to release the springs.

(iii) To remove magazine platform, spring, and bottom plate.

Proceed as for the P. '14.

(iv) To assemble magazine platform, spring, and bottom plate.

As for the P. '14.

(c) Applied and mechanical safety devices.

(i) Applied safety.

Safety-catch on the rear of the bolt, working laterally. It operates in three positions as follows:

1. When turned to the *right* (which can only be done when the rifle is cocked) the catch is in action and the rifle is at "safe".
2. When turned into the vertical position, the bolt may be stripped by unscrewing the cocking-piece and assembly from the body of the bolt.
3. When turned to the *left*, the catch is inoperative, the bolt may be manipulated, and the rifle fired.

(ii) Mechanical safety.

If the bolt is not properly closed, the cam on the cocking-piece will strike the cocking-cam on the bolt, and the energy of the main spring will be expended in closing the bolt, instead of in striking the cap of the cartridge. This prevents the possibility of the cartridge being fired until the bolt is fully closed. Obviously a miss-fire may result.

(d) Special features and general information.

This rifle is the only service rifle which attempts to correct for drift, i.e. the lateral movement of the bullet set up by the

twist of the rifling. Drift for service purposes is an unimportant item since the amount is negligible when compared with wind and other factors. A description of the backsight is as follows:

The leaf is graduated from 100 to 2,850 yards. The lines extending across one or both sides of the leaf are 100-yard divisions, while the longer of the short lines are 50-yard, and the shorter lines 25-yard divisions.

The drift slide is attached to the slide proper. The latter has a small aperture near the base, a triangular opening with an open sighting notch, and another open sighting notch in its upper edge. As the slide is moved up the scale, so it is moved over to the left by the drift slide, thus automatically compensating for drift.

With the leaf up, ranges from 100 to 2,350 yards can be obtained through the aperture; from 100 to 2,450 through the open notch at the bottom of the triangular opening; and from 1,400 to 2,750 yards through the open sighting notch in the upper edge. The 2,850-yard range is obtained through the open notch in the upper end of the leaf itself.

With the leaf down there is a battle sight which is calibrated for 530 yards.

7. U.S.A. .300-INCH GARAND SELF-LOADING RIFLE.

(a) Particulars.

Service designation.	U.S. Rifle cal. 30 M1.
Weight.	9½ lbs.
Weight with bayonet.	10½ lbs.
Length.	3 ft. 7 ins.
Length with bayonet.	4 ft. 11 ins.
Capacity of magazine.	8 rounds.
Charger or clip loading.	Clip.
System of operation.	Gas.
Locked or unlocked.	Locked.
Ejection.	Right side—upwards to right front.
Bolt-lever or cocking-lever.	Right side.
Condition of breech on:	
(a) Cease fire.	Closed.
(b) Empty magazine.	Open.
Types of fire.	Single shot only.
Type of sights.	Aperture.
Range of adjustment.	200-1,200 yds.
Cut-off for magazine.	Nil.

(See Figs. 3A and 3B, p. 38B).

(b) General particulars.

This is a self-loading rifle. On the trigger being pressed, a round is fired, the empty case is ejected, a fresh round is fed into the chamber and the breech is closed without any further action on the part of the firer. The above operations are carried out by utilizing a portion of the spent gases. These are trapped at the muzzle and operate on a piston which lies on the underside of the barrel.



.300 INCH U.S.A. GARAND S.L. RIFLE.

FIG. 3A.

When a clip is empty, it is ejected from the rifle and the bolt is held to the rear, i.e. the action remains "open," in a position in which another clip can be immediately loaded.

The ejection of the clip makes a "pinging" sound which is unmistakable.

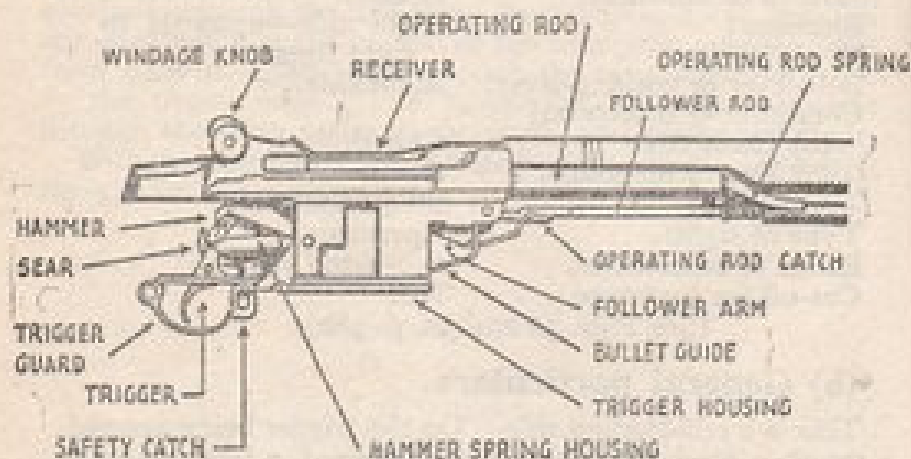

RIGHT SIDE OF .300 GARAND

FIG. 3B.

(c) Loading and unloading.

(i) To load a clip.

Clips are normally issued already loaded with eight rounds. If, however, it is desired to reload an empty clip, it will be found best to insert the rounds so that the lowest round is on the left side when the clip is presented to the rifle. If you look at the clip you will find a small nipple on the bottom left and top right sides. The lowest and topmost rounds should be opposite each of these nipples. It is not essential to load the clip in this way since the "follower" will function with clips loaded in the reverse manner. Experience has shown, however, that the method indicated is the better of the two.

The clips themselves are reversible and can be used either way up.

(ii) To load the rifle.

1. Pull the handle of the operating rod fully to the rear. In this position the face of the bolt is well clear of the rear of the "follower" and is held back by the holding open catch.

N.B. The "follower" is that portion which takes the place of the normal magazine platform.

Note. The bolt can be held to the rear by the bolt face engaging behind the follower. In this position the rifle is not fully cocked and the clip cannot be inserted.

2. Place a loaded clip on top of the follower. With the right side of the right hand against the handle of the operating rod, hold the latter to the rear; with the right thumb push the clip down firmly until the clip latch engages. Clear the thumb from the front of the bolt by swinging it over to the right and at the same time remove the right hand. The operating rod, under the influence of its spring, will now fly forward and the bolt will take the top round out of the clip and place it in the chamber. If required the heel

of the right hand can be used to give added impetus to the operating rod in its forward movement.

3. Apply the safety-catch. The catch is just in front of the trigger guard. To set at safe pull back towards the trigger.

N.B. The safety-catch will only act when the rifle is cocked.

(iii) To unload the rifle.

1. Push safety-catch forward, if applied.
2. Pull the operating rod handle sharply to the rear and hold it to the rear with the thumb of the right hand. Curl the remaining fingers of the hand round the trigger guard or the small of the butt. Pulling back the operating rod handle will eject the live round in the chamber.
3. Place the left hand over the receiver with the fingers on the right side of the rifle and the thumb on the left by the clip latch. Press in the clip latch with the thumb. The clip and remaining rounds will then be ejected upwards into the left hand.
4. To close the bolt, keep the operating rod handle to the rear with the right thumb and with the thumb of the left hand depress the follower. Then ease the operating rod forward.
5. Press the trigger.

Note. If it is desired to close the bolt on an empty chamber, while still retaining rounds in the magazine (clip), proceed as in 4 above after having unloaded the live round in the chamber as described in 2 above.

(d) Elementary stripping and assembling.

(i) To strip.

1. Turn rifle upside down.
2. Unlatch the trigger guard by pulling upwards and to the rear.

3. Continued upward pressure removes the trigger group complete.

4. Turn the rifle the right way up and with the thumb and forefinger of the right hand on the backsight, lift the receiver and barrel groups from the fore-end.

(ii) To assemble.

Reverse the above procedure, making sure

- (i) That the action is cocked before insertion, and
- (ii) That the trigger group is correctly housed (i.e. the stud on either side of the action is at the top of the inclined keyways in the receiver) before the trigger guard is fully pressed down and latched.

(e) Additional stripping and assembling.

When firing has been carried out, or in circumstances where excessive dust or sand are present it will probably be necessary to strip further for adequate cleaning. In this event carry on stripping as follows:

(i) To strip additional components.

1. Turn the action upside down and remove the follower rod and operating rod spring. Do this by pushing the follower rod against the spring and disengaging its claws from the studs on the follower arm.

Note. Early models have a compensating spring on the follower rod. Later models only have a single operating rod spring.

2. With the combination tool, or a punch or a nail, force out follower axis pin and remove
 - (a) Operating rod catch.
 - (b) Follower arm.
 - (c) Bullet guide.
 - (d) Follower and slide.
3. Turn the action with the right side uppermost. Draw

back the operating rod until the lug on the rod coincides with the "dismount" notch which is just in front of the right (deflection) thumbscrew of the backsight. The rod can then be disengaged from the bolt by lifting the rod towards the sight. Push the rod forward again slightly to clear the front of the receiver and then withdraw to the rear.

4. Remove the bolt as follows:

- (i) Lift the bolt head up by pulling to the right. This depresses the tail. The best position is about half-way back along the runway.
- (ii) Keeping hold of the bolt head twist the lug on the left rear-side until it is in its assembly recess on the left side of the receiver, then twist the bolt *clockwise* slightly and pull forwards to the right front. The bolt will then be cleared from the receiver.

Note. The above operations are a little tricky. Do *NOT* use force. If you feel you want to force the bolt out, you are being stupid. A little coaxing and practice will work wonders.

(ii) To assemble additional components.

Reverse the above operations.

Note 1. The best method of getting the bolt back is as follows:

- (i) Insert the rear end of the bolt in the runway so that the lug on the left rear is in its assembly recess. This means that the top surface of the bolt is inclined downwards to the right at about 30 degrees.
- (ii) Lift up the head of the bolt and twist it to the right front until the tail of the firing-pin passes through its assembly slot in the frame of the receiver.

DO NOT USE FORCE.

Note 2. When assembling follower arm do not forget to see that the two lugs are correctly housed in the slots of the follower.

(f) General points of interest.

At first sight a self-loading rifle may appear to have many advantages. There are, however, certain limitations and some of the advantages are not so very clear-cut if they are analysed in an abstract manner.

A self-loading rifle is more complicated, both to manufacture and to maintain, than one of the normal hand operated type. There is always the possibility of a jam through mechanical failure. This is especially the case in sandy or dusty conditions.

With a manually operated rifle the time taken to fire a number of shots in rapid succession depends on

- (i) The firer's mechanical proficiency in opening and closing the bolt.
- (ii) The time he takes over aiming with each shot.

With a good rapid shot, the time taken for (i) is very small compared with that required for (ii). A self-loading rifle decreases the time required for (i), i.e. the manipulation of the bolt; it does not decrease the time taken for (ii), i.e. the aiming time.

It is in fact open to argument whether or not the aiming time is not increased slightly. The reason is this; with a hand operated rifle, the movement of reloading is under the firer's control; the rifle therefore is brought back to the point of aim during reloading. With a self-loading rifle, the reloading is effected mechanically and is out of the firer's control. He therefore has to make a conscious effort to get the rifle back on the mark again.

The above remarks should not be taken as being in any way derogatory to self-loading rifles. They are merely intended to show that a self-loading rifle, while an advance, is not necessarily a huge advance on a manually operated one.

9. .30-INCH SELF-LOADING CARBINE M.1. (U.S.A.).

(a) Particulars.

Service designation	U.S. Carbine cal. .30, M1.
Weight (unloaded).	5 lbs. 3 ozs.
Length.	36 ins.
Magazine capacity.	15 rounds.
Method of loading.	Insertion of full magazine.
System of operation.	Gas.
Locked or unlocked.	Locked.
Ejection.	Upwards to right front.
Cocking lever.	Right side.
Condition of breech on:	} Closed.
(a) "Cease fire"	
(b) Empty magazine	
Type of fire.	Single shots only.
Sights: Type.	Blade and Aperture. Early models—double battle sight. Later models will have an adjustable backsight.
Range of adjustment.	Double battle sight. 200 and 300 yds. Adjustable sight, 100 to 300 in 80 yd. steps.
Ammunition.	Special .30 Carbine ammunition with a muzzle velocity of 1,900 f.s. is used.

(b) General particulars.

This weapon, which is the only one of its kind in use amongst the armed forces of the powers, is a miniature edition of the Garand rifle and has been evolved as a substitute for the pistol. It is to be carried in the U.S. Army by

officers, N.C.O.s and others previously armed with the Colt Automatic pistol and must not be regarded so much as a light rifle but rather as a heavy and accurate two-handed pistol with the added advantage that it has offensive qualities as well as being purely a weapon for personal defence.

It will only fire one shot for each pressure of the trigger. Its general mechanism is similar to that of the Garand rifle, and at 100 yards its accuracy is roughly comparable with the service rifle. At 300 yards, however, the bullet, by reason of its lightness and relatively low velocity is more affected by



U.S. CARBINE Cal. 30 mi.

(Winchester)

FIG. 3C.

wind than a rifle bullet. The necessary allowance for wind is about three times as great with the carbine as it is with the No. 1 or No. 4 Rifles and Mk. VII ammunition.

(c) Loading and unloading.

(i) To load the magazine.

Press each round into the magazine between the lips. As the ammunition is rimless this is a very simple operation.

(ii) To load the carbine

1. Push the magazine into the magazine opening until the

magazine-catch engages the twin lugs on the back of the magazine.

2. Pull back the cocking-handle to its full extent and allow it to go forward sharply. The carbine is now ready to fire. Unless you wish to fire immediately, apply the safety-catch by pressing in the stud protruding on the left of the forward end of the trigger-guard.

(III) To unload.

1. Press the magazine-catch, which will be found on the right of the carbine just in rear of the top of the magazine, and the magazine may then be withdrawn. It should not be allowed to *drop* out unless you have no further use for it.

2. Pull the cocking-handle back sharply as far as possible. This will extract and eject the live round in the chamber.

3. If at "safe" push the safety-catch over to the left, i.e. to the "fire" position, press the trigger, and re-apply the safety-catch.

(d) Stripping and assembling.

(i) To strip.

1. Remove sling, oil bottle, and magazine, and see that the weapon is not loaded.

2. Unscrew the screw securing the band and the forward sling swivel—this may be done with the base of a cartridge.

3. Press in the band retaining-spring on the right of the carbine and slide the band forward until clear of the stock.

4. Lift off the handguard, first sliding it forward out of engagement with the slot in the forward end of the body.

5. Lift muzzle of barrel away from stock until the lug at the rear of the body disengages from the recess in the stock. Remove barrel, body and trigger group from stock.

6. With any convenient instrument push out to the right the trigger group retaining-pin (at the front end of the trigger group) as far as possible and then slide the trigger

group forward until clear of the grooves on the underside of the body.

7. Pull back the return spring until the return-spring pin is clear of its socket in the actuating-rod; ease to the right and remove return spring and pin.

8. Pull back the cocking-handle, pulling upwards and outwards until, when the bolt is about two-thirds back, the lug on the cocking-handle end of the actuating-rod comes away from the groove on the right side of the body. Then ease the actuating-rod forward about $\frac{1}{4}$ in. until the lug on the left of its forward portion drops through the gap in the groove on the left of the barrel. The actuating-rod then comes away with a slightly anti-clockwise movement, since the lug on the right of its forward portion is allowed to disengage from the groove on the right of the barrel.

9. Move the bolt to a position where the forward edge of the right-hand bolt lug is about $\frac{1}{4}$ in. in rear of the right-hand locking shoulder in the body (the exact place must be found by trial), then, gripping the right bolt lug lift it and twist the bolt anti-clockwise on to its back, draw forward at an angle of about 45 degrees, and remove from the recess in the body.

(II) To assemble reverse the above procedure, paying attention to the following points:

1. In replacing the return spring and pin take care not to bend the latter and do not use undue force. If difficulty is found in packing the tip of the rod far enough to the rear with the finger, use a coin.

2. Before trying to assemble the trigger group to the body see that the hammer is in the cocked position with the safety-catch applied.

3. Before assembling the body, barrel and trigger groups into the stock, test the mechanism for functioning.

4. Do not screw up the band-screw so tight that the sling swivel cannot move.

SNIPING RIFLES AND TELESCOPES

9. RIFLE No. 3 Mk. I* (T).

(a) Particulars.

(i) Particulars of rifle.

Owing to the fact that the locking lugs are at the forward end of the bolt and therefore the latter is not in a state of compression when a shot is fired, and that the body is considerably stronger and the barrel heavier, accuracy at short ranges is much superior to the S.M.L.E. For this reason this rifle has in a certain number of cases been fitted with a telescopic sight for sniping purposes. When so fitted the designation is as above.

Fittings to take the telescope are fixed to the front of the top of the body and the left side of the backsight bracket. The telescope fits on by means of two legs which hook into the front fitting on the rifle. The rear fitting on the telescope has a single leg, the squared end of which drops into the rear fitting on the left side of the rifle body and is secured by a swing-over locking bolt. The telescope is sited centrally over the axis of the bore.

(ii) Particulars of the Telescope. Pattern '18.

Magnification. $\times 3$.

Field of view. $7\frac{1}{2}$ degrees.

There is a focusing adjustment to allow for varying eyesight; lateral adjustment is catered for optically. The telescope contains a cross-wire and a pointer which can be zeroed for range by an adjustable range-drum.

To aim, move the head until the field of view is clear; in general it will be found that somewhere between one and

P'18 TELESCOPIC SIGHT

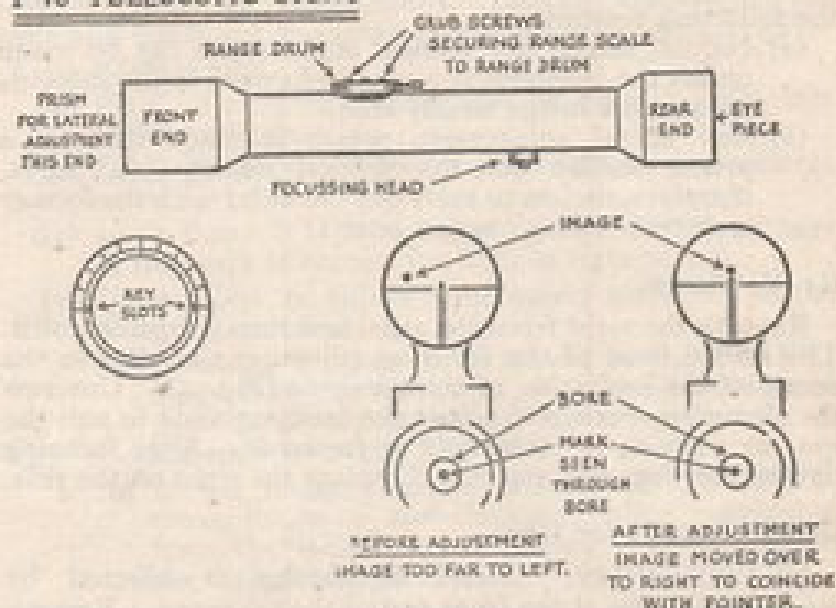

FIG. 4.

a half to two inches away is about correct. If any blurring of the outside edges of the field of view is seen, the head is not correctly positioned. Aim is taken by putting the tip of the pointer at six o'clock on the mark.

(b) How to adjust a telescope to a rifle and to an individual.

There are three adjustments to be made, viz:—

1. Focusing.
2. Lateral.
3. Vertical.

These adjustments must be made in the above order, for the following reasons:

- (a) Neither lateral nor vertical adjustments can be made unless the telescope is correctly focused to the individual and the image clearly seen.
- (b) Any lateral adjustment, which is made through a prism, throws out the vertical adjustment. It is, therefore, useless to carry out the latter with the former incorrect. (Explanation later.)

(I) To focus.

Remove the sight from the rifle, and turn it upside down. The milled head of the focusing adjusting slide lies in the centre of the underside of the telescope (Fig. 4). Unscrew the clamping screw and adjust the focusing slide to suit the eye, by pushing it backwards or forwards. After focusing tighten the clamping screw and replace the sight on the rifle.

(II) To adjust for line.

(a) PRELIMINARY. Lateral adjustment is effected by means of a prism at the front end of the telescope. Remove the front shade, slacken the three screws which fix the prism cell and, by means of the adjusting key, rotate the prism to the right or left as necessary.

There is a reference line on the outer ring which encloses the prism cell, and a number of divisions on the member enclosing the latter. The scale made by these divisions is practically a full semi-circle. The reference line must be somewhere on this scale. If it is not, turn the prism cell until it is.

The centre line of this scale should be regarded as being at twelve o'clock. Divisions to the immediate right or left will then give a lateral adjustment of five minutes of angle. Divisions at the extreme-ends of the scale will only produce a lateral alteration of approximately one minute of angle.

(b) METHOD OF ADJUSTMENT. Having uncovered the scale and slackened the three prism cell retaining screws:

- (i) Remove bolt.
- (ii) Place rifle on an aiming rest or prop it up firmly with sandbags.
- (iii) *Looking through the bore*, lay the rifle on any suitable mark.
- (iv) Look through telescope and see whether the image of the mark is correct for line, or right or left.
- (v) Leave alone, or adjust as necessary according to the following rules:
 - (a) If image requires to be moved to the RIGHT, move the scale clockwise when considered from the REAR, or anti-clockwise when looking at the scale from the FRONT.
 - (b) If the image requires moving to the LEFT, move the scale anti-clockwise when considered from the REAR, or clockwise when looking at the scale from the FRONT.

N.B. An alteration of the range setting may be necessary at iv or v above, in order to get the image in line with the top of, or on top of, the pointer. Do not worry about this at this stage. You are going to adjust for range later.

An alternative method of adjustment is by actual shooting, in which case you must remember the following rules:

- (a) If the shots strike to the RIGHT of the mark, the image must be moved to the RIGHT.
- (b) If the shots strike to the LEFT of the mark, move the image to the LEFT.

(iii) To adjust for range.

This is best explained by an example. Having tested or corrected for line, and shot the rifle at a known range say

500 yards, and having perhaps 700 yards on the range-drum indicator, proceed as follows:

- (a) Unscrew the two grub screws which secure the range scale to the range-drum head.
- (b) Rotate the range scale until the figure 5 (representing 500 yards) is opposite the indicating line at the side. This does not alter the position of the pointer inside the telescope since the range scale has been freed from the range-drum head.
- (c) Tighten up the two grub screws again. The range scale will then be correctly adjusted to the shooting of the rifle.

10. RIFLE No. 3 Mk. I* (T) A.

This is a P. '14 rifle fitted with an Aldis type telescopic sight. A small number of these, attached by permanent fixings to the rifle, were issued at an early stage of the present war.

The telescope is similar in appearance to the P. '18, but it has no optical lateral adjustment. This is catered for mechanically in the fitting which attaches the telescope to the rifle. Focussing and range adjustments are carried out in the same manner as for the P. '18 telescope.

The telescope is attached to the rifle on the left side and slightly above the body; not vertically above the centre line of the bolt as is the case with the combination of P. '14 rifle and P. '18 telescope. This offset position obviously is not the most suitable place for a telescopic sight. Accordingly a detachable check rest was evolved for use with this rifle and telescope. This allows the firer to maintain a firm pressure on the butt with his cheek in a normal manner instead of having to contort his face. The check rest is shaped to the butt and is attached by means of a single wood screw.

Since the telescopic sight is permanently attached to the rifle, the normal rifle breech cover cannot be used. A complete cover for breech and telescope has therefore been issued for use with this equipment. The cover has a hole in it, which is suitably circled with a leather fringe, and through which the knob of the bolt fits.

Subsequent to the need for a check rest with this rifle becoming evident, it was realized that the same check rest would be a great assistance both with the normal equipment of P. '14 and P. '18 telescope, and also with the forthcoming Rifle No. 4 Mk. I and the new sniper's telescope. The

check rest has therefore become a universal issue for all sniper's rifles fitted with telescopes.

ADJUSTMENTS.

- (i) Focusing. As for P. '18.
 (ii) Lateral. The telescope is attached at the front end to the rifle by means of a stout screw driven into a bracket which is clamped to the rifle. This screw permits movement in a lateral plane. The rear of the telescope is attached in the same manner except that the hole in the bracket for the rear screw is elongated in order to cater for adjustment.

Zeroing must be effected by trial and error. When correctly zeroed for line the armourer should scribe a line on the adjustment plate to indicate the datum zero position.

Since the lateral adjustment is mechanically effected there is no necessity for the range adjustment to be carried out last. In fact it will be found to be easier to correct for line in this case when the range adjustment has been attended to previously.

- (iii) Range adjustment. As for P. '18.

11. RIFLE No. 4 Mk. I* (T).

(a) Particulars.

This rifle is the sniping edition of the normal No. 4 Mk. I. It has special fittings to accommodate a new type of telescope which is known as the No. 32.

The fittings consist of front and rear pads on the left side of the body of the rifle. In order to keep the position of the telescope as low as possible, the normal BATTLE sight aperture is removed.

(1) Particulars of the telescope No. 32.

Magnification—X₃.

Field of view—9 degrees.

Cross wires and pointer are as in the P.18.

Range drum on top
 Deflection drum on left } of telescope.

There is NO focusing adjustment.

A bracket on the sight has two thumbscrews which clamp into the two pads on the rifle. Each thumbscrew has a spring washer.

The telescope has sunshades at both front and rear ends.

(II) Particulars of accessories.

The rifle is issued in a small single rifle chest complete with all necessary accessories. The chest itself has two leather handles at the point of balance for carrying purposes. The telescope is housed in a metal case. This is fitted with a sling for carriage on the man when the chest is not being utilized. The case and sling are accommodated in the chest underneath the rifle.

The telescope-case contains the 'scope (on which are two leather end-caps connected by a strap—these are intended

to keep the glass clean), an adjusting tool for the range and deflection drums, and a piece of cleaning material for the eye pieces of the scope.

Screwed to the butt of the rifle is the usual wooden cheek rest which is now the normal issue for all snipers' rifles—see last para. in section 9 on page 44.

Attached to the rifle is an American type loop sling which assists in keeping the rifle steady when no rest is available.

Inside the lid of the chest is a list of the contents and notes on important points in the care of the equipment.

Since each rifle is specially fitted with its telescope it is necessary to keep the two items "paired up." With this in view the serial number of the rifle is painted on the outside of the telescope-case, the serial number of the telescope is stamped on the small of the rifle-butt just below the cocking-piece, and the numbers of both rifle and telescope are recorded on the inside of the lid of the telescope-case.

(b) How to adjust.

Note 1. As mentioned in the particulars of the telescope, there is no focusing adjustment. The telescope has been so constructed that such an adjustment is unnecessary.

Note 2. This telescope is easier to adjust than either of the other two telescopes referred to in the preceding sections.

Note 3. It is immaterial which adjustment (line or elevation) is carried out first.

To adjust for range, and/or line.

1. Adjust the range and/or deflection drums until the M.P.I. of your group is the same as your point of aim.

2. Alter the range and/or deflection drum readings to coincide with the range at which you are firing and/or zero for line.

N.B. It is generally best to zero for line at very short range in order to eliminate errors due to badly estimated wind effects.

Note. Alteration of the settings of the drum readings is carried out as follows:

- (i) Place adjusting tool over the drum so that the slot on the end of the upper tommy-bar and the lugs on the base of the lower tommy-bar both engage with the projection and slots respectively of the drum.
- (ii) Get a comrade to hold the upper tommy-bar firmly in position and rotate the lower bar about half a turn *anti-clockwise*. This allows the scale to be rotated.
- (iii) Still holding the upper tommy-bar stationary, rotate the scale until the desired setting is opposite the pointer.
- (iv) Clamp the scale in its new position by turning the lower tommy-bar back *clockwise* as far as it will go. *Note.* The upper tommy-bar and drum must be kept stationary while you are doing this.

N.B. The above operations are a two-man job.

(c) Notes on the use of the sling when no cover is available.

The sling is meant to *assist* you to keep the rifle steady. It is *NOT* the means of keeping the rifle steady. Your right hand and chin must do that. The best results will be obtained by having the sling sufficiently tight, but not too tight, to act as a slight support.

The sling should be tucked well up into the armpit. The loop should be so arranged that there is no feeling of constriction on the left upper arm when the sling is in position.

(d) Notes on the use of cover.

When firing over cover, do *NOT* rest the rifle on the cover. Always rest the wrist or the back of the hand. If you rest the rifle you will seldom, if ever, rest it in the same place for two consecutive shots. Resting the rifle affects "jump" and hence inaccuracies result if different portions of the rifle are rested on the cover.

12. .300-INCH BROWNING AUTO RIFLE

(a) Particulars.

Service designation.	.300-inch Browning Auto Rifle.
Weight.	15 lbs. 12 ozs.
Length.	3 ft. 7 ins. approx. (without flash reducer).
Locked or unlocked.	Locked. Rear end of breech-block rises.
Capacity of magazine.	20 rounds.
Charger or clip loading.	Spare magazines are used for replenishment of the rifle, but there is a separate "charger guide" (sometimes called a "magazine filler") by means of which spare magazines can be refilled by utilising the normal brass type of U.S.A. charger holding 5 rounds.
Type of sights.	Aperture.
Range of adjustment.	200-1,600 yards. Battle sight 400 yards.
Cut-off for magazine.	Nil.

(See Fig. 3, p. 29.)

GENERAL DESCRIPTION

This is a heavy type of automatic rifle, or, if you prefer to call it so, a light type of light machine-gun.

It can fire either single shots or fully automatic bursts. There is a change lever on the left hand side of the weapon

just beside the back of the trigger guard. There are three letters to indicate what happens when the change lever is in each of the three positions:

- F. Forward position = Single shots.
- A. Centre position = Fully automatic.
- S. Rear position = Safe.

There is a small safety stud operated by a spring in between A and S to ensure that the change lever does not slip to "Safe" during firing automatic. This also helps to keep the change lever at "Safe" when it is to the rear.

These weapons take .300-inch ammunition and, like the U.S.A. rifles and Lewis guns, have a red band painted on the body.

The weapon should be rested on cover if possible or else fired in the open like a rifle. *Normally, the weapon should be used for firing single shots, the fully automatic capacity only being employed in an emergency.* Besides avoiding waste of ammunition, this disguises the fact that an automatic weapon is present, until the enemy is too close to do anything about it.

(b) Stripping and Assembly.

(i) To strip.

1. Remove magazine by pressing in catch inside front of trigger guard.
2. Ensure that the rifle is unloaded by pulling back the cocking-handle.
3. Leaving the rifle cocked, rotate retaining pin at left front of body, half turn clockwise and remove.
4. Pull forward handguard complete with gas cylinder and remove.
5. Press the trigger, and control forward movement of action.
6. Turn rifle upside down.
7. Rotate retaining pin on left of trigger guard quarter turn clockwise and remove.

8. Remove trigger group complete.
9. With piston right forward, turn the back end of the mainspring rod out of its slots on the inside of the front of the body.
10. Withdraw mainspring and rod to the rear.
11. Pull back the cocking-handle slightly less than half an inch, until the end of the lynch-pin can be seen through the hole in the opposite side of the body.
12. Knock out lynch-pin from the cocking-handle slide.
13. Pull piston back and lift out hammer from underneath rear end of piston by sliding it forward.
14. Push breech-block right forward as far as it will go.
15. Pull out piston to the front.
16. Slip a wire paper-fastener, or some such article, through one of the lynch-pin holes in the breech-block link. Push the breech-block as far to the rear as it will go. Then with the side of a screw-driver blade press out the bolt retaining catch on the left of the body (upside down view of this is on the right) and pull out the breech-block by lifting from the rear end.
17. The firing-pin can then be withdrawn from the breech-block.
18. Withdraw cocking-handle and slide.

N.B. Do not attempt to strip the trigger mechanism.

(H) To assemble.

Reverse the above, paying attention to the following points:

- (1) When replacing breech-block be sure to see that the front end is clear of the projections inside the front of the body. Then press the block down over the spring retaining catch.
- (2) To reassemble lynch-pin, get the cocking-slide in the correct position and then roughly align the three components, breech-block, hammer and rear of

piston. Using the trigger group retaining-pin as a guide on the cocking-slide side, insert lynch-pin from the right and press home.

- (3) Before assembling handguard complete, cock the rifle.
- (4) When the handguard has been assembled press the trigger.

(c) Applied and mechanical safety devices.

The applied safety has been dealt with already in the general description.

Mechanical safety is ensured by the fact that the hammer, which is actuated by the piston, is unable to get at the rear of the firing-pin until the breech is fully locked.

(d) Preparation for firing.

Set gas regulator at the smallest setting. There are three sizes of holes marked on the front of the regulator. The hole in operation is that which is directly under the barrel.

To turn regulator and reset, the split fixing-pin must be pushed out sufficiently far to enable the regulator to turn. The nose of a bullet will serve this purpose.

(e) Stoppages and Immediate Action.

In the event of a stoppage carry out the following immediate action:

- (i) Cock rifle.
- (ii) Remove magazine.
- (iii) (a) If the magazine is empty—change it.
(b) If top round is half out or misplaced in the magazine—correct it, and replace magazine.
(c) If the top round is damaged—remove it, and replace magazine.

In the event of recurring feed stoppages, increase gas.

13. 7.92 mm. GERMAN MAUSER.

(a) Particulars.

Weight	} less bayonet	{ 9 lbs. 12 ozs.
Length		
Capacity of magazine.		5 rounds.
Charger or clip loading.		Charger (small brass type).
Type of sights.		Open V notch and barleycorn.
Range of adjustment.		Graduated 400-2,000 metres.
Cut-off for magazine.		Nil.

(See Fig. 3, p. 39).

(b) Removal and replacement of bolt.

(i) To remove bolt.

There is a catch on the left of the body of similar type to that on the Rifle No. 3 (P '14), and it acts in a similar fashion. Press out front end to left and withdraw bolt.

(ii) To replace bolt.

As for P '14.

Note. The magazine is not removable.

(c) Applied and mechanical safety devices.

(i) Applied safety.

Safety-catch on the bolt plug of the same type as the American Springfield. It is only operable in the cocked position. When turned to the "LEFT" the catch is out of action and the rifle can be fired. The catch operates when swung over to the right. The rifle is then at "SAFE" and cannot be fired. There is an intermediate position

between these two, i.e., with catch vertical. When placed in this position the rifle cannot be fired, but too much reliance should not be placed upon it since the catch can easily be knocked out of the small positioning recess. With the safety-catch in this position the bolt may be stripped by unscrewing the cocking-piece assembly from the body of the bolt.

(ii) Mechanical safety.

Much the same as in the American Springfield. The bolt, if not properly closed, is closed by the cocking-piece striking the cam groove. In such an event a misfire may result.

(d) Special features and information of interest.

There are no special features. This rifle has been in existence for many years and is the parent weapon of similar types of Mauser used by Belgium, Spain, and Turkey. The bolt lever is straight and sticks out to the right at right angles. This makes the action an extremely awkward one for rapid reloading.

14. GERMAN 7.92 mm. SELF-LOADING RIFLE. G.41 W.

(a) Particulars.

Service designation.	German S.-L. rifle, 7.92 mm. (G.41 W.).
Weight	19 lbs. 14 ozs.
Length	3 ft. 9 ins.
Capacity of magazine.	10 rounds.
Charger or clip loading	Charger (small brass type).
System of operation.	Gas.
Locked or unlocked.	Locked.
Ejection opening.	Right side.
Bolt lever or cocking-lever.	Right top.
Condition of breech on:	
(a) "Cease fire"	Closed.
(b) Empty magazine.	Open.
Types of fire.	Single shots only.
Type of sights.	Open.
Range of adjustment.	1-1,200 metres.
Cut-off for magazine.	Nil.

(b) Loading and unloading.

Loading is by means of the normal German charger of 5 rounds. When the magazine is empty, the magazine platform holds up the bolt in its forward movement and acts as a "holding-open device."

(c) Stripping and assembling.

(i) To Strip.

1. Lock.
2. Switch safety-catch over from "left" to "right," i.e. "Fire" to "Safe."

(Note. The safety-catch which is the lever at the rear end of the action is not marked.)

3. Pull back the cocking-cover to the fullest extent. Press in the cover locking-catch, which is just to the left of the cocking-lug on the cocking-cover. This locks the bolt to the cocking-cover.

4. Push in the retaining-catch, i.e. the milled-headed stud just above the safety-catch and lever up the breech mechanism from the rear.

5. Breech mechanism and cocking-cover can now be removed.



7.92 mm GERMAN SELF-LOADING RIFLE-G.41(W)

FIG. 4A.

6. Placing the face of the bolt on a wooden or soft surface, push down the rear end of the receiver and return the cocking-cover catch.

7. The following components will then come adrift:

- (i) Receiver.
- (ii) Two mainsprings and mainspring rod.
- (iii) Bolt.
- (iv) Cocking-cover.
- (v) Bolt locking-lugs.
- (vi) Firing-pin.

(ii) To Assemble.

1. Place the firing-pin in the bolt with the cocking-lever recesses upwards. Do not push firing-pin right forward but only let its nose show in the cocking-recess of the bolt.

2. With the bolt in an upright position, carefully insert locking-lugs in their recesses and then push the firing-pin forward.

3. Insert the cocking-lug of the cocking-cover in the recesses of the firing-pin and bolt.

4. Assemble mainspring rod and mainsprings in the receiver.

5. Insert mainsprings into the recesses above the firing-pin and push forward.

6. See that:

(i) The nib of the sliding cover on the receiver hooks into the recess in the top of the cocking-cover.

(ii) That the ribs on the receiver correctly engage in their recesses in the cocking-cover.

7. Compress the mainsprings to the fullest extent and press in the cocking-cover catch, thus locking the component parts of the breech mechanism together.

Note. It will be found to be of assistance to grasp the locking-lugs with the left hand and to keep them firmly pressed in, thus ensuring that the cocking-nib is retained in its recess in the firing-pin.

8. Insert the complete breech mechanism in the rifle, front end first, ensuring while so doing that the ribs on the body engage in their recesses in the receiver. Then push in the retaining-catch at the rear of the mechanism and lower it with its seating in the body.

9. Turn safety-catch over from "Safe" to "Fire," i.e. from right to left.

10. Press out the cocking-cover catch.

11. Press in the holding-open device catch on the left of the body, thus allowing the mechanism to fly forward.

12. Press the trigger.

Note. There is an additional and different type of German self-loading rifle. This will be dealt with in a later edition when particulars are available.

15. .256-INCH MANNLICHER-CARCANO (ITALY).

(a) Particulars.

Weight	} less bayonet	{ 9 lbs.
Length		{ 4 ft. 2½ ins.
Capacity of magazine.		6 rounds.
Charger or clip loading.		Clip.
Type of sights.		V and barleycorn
Range of adjustment.		600 to 2,000 metres.
Cut-off for magazine.		Nil.

(See Fig. 3, p. 29.)

(b) Removal and replacement of bolt.

(i) To remove bolt.

Lower retaining bolt on right side of body and pull trigger.

(ii) To replace bolt.

Push bolt in while keeping trigger pulled.

Note. There is no magazine in the accepted sense of the word. In place of it there is a strong spring-supported arm, with no bottom plate to the magazine opening on the under side of the body. It is clip loaded, and the empty clip drops out through the bottom opening. The spring-supported arm rides up inside the middle of the clip.

(c) Applied and mechanical safety devices.

(i) Applied safety.

Safety-catch on rear of bolt plug. To apply, press in and rotate to the left. To prepare for firing, reverse this procedure.

(ii) Mechanical safety.

As for Mauser.

(d) Special features and information of interest.

The only special feature is of a purely technical nature. The grooves of the rifling have a progressive twist which gradually increases towards the muzzle. There is no merit in this and it is possible that in later models it has been discontinued.

The bolt lever is further forward in Mannlicher actions than it is in Mauser actions.

General note regarding German and Italian rifles.

The notes in sections 12 and 13 deal with weapons which have been the basic arms of these countries for many years. It is now known, however, that both nations have introduced shorter and lighter models for general purposes. In the case of Germany a large number of troops are now armed with carbines in place of rifles, whilst the Italians have also adopted carbines on a large scale and at the same time have increased the calibre of their rifle to 7.35 mm. instead of 6.5 mm. and have done away with the progressive twist in the rifling referred to above. The basic mechanisms of these rifles and carbines, however, have not altered appreciably.

16. .55-INCH BOYS' ANTI-TANK RIFLE.

(a) Particulars.

Service designation.	Rifle Boys', Mark I.
Weight.	35½ lbs.
Length.	5 ft. 4 ins.
Feed.	Overhead box magazine.
Magazine capacity.	5 rounds.
Ejection.	Underneath.
Sights.	Aperture.
Range of adjustment.	2 fixed settings—300 and 500 yds.

(See Fig. 5, p. 55).

(b) Removal and replacement of bolt.

(i) To remove bolt.

Open bolt and depress small catch just beneath the magazine catch. Withdraw the bolt.

(ii) To replace bolt.

Reverse the above.

(c) Loading and unloading.

(i) To fill magazine.

You must be careful to push the base of the round back from in front of the two lips of the magazine. Do not attempt to force the round downwards between the lips.

(ii) To load.

As for Bren.

(iii) To unload.

As for Bren. The magazine catches are of the same type.

(d) Special features of information and interest.

1. The monopod support folds forwards. It is held fast in either the firing or folded position by a strong spring-controlled stud on the right-hand side at the pivot-axis of the monopod. To change from one position to another press in the stud, and place the monopod in the desired position.

2. Safety-catch on left side "Fire" is forward. "Safe" is with catch turned to rear.

3. In order to speed up production the monopod, which requires considerable machining, has now been superseded by a bipod which, by an ingenious quick-release, can easily be detached from the rifle. This is a great advantage when the weapon is mounted in an A.F.V.

BOYS RIFLE

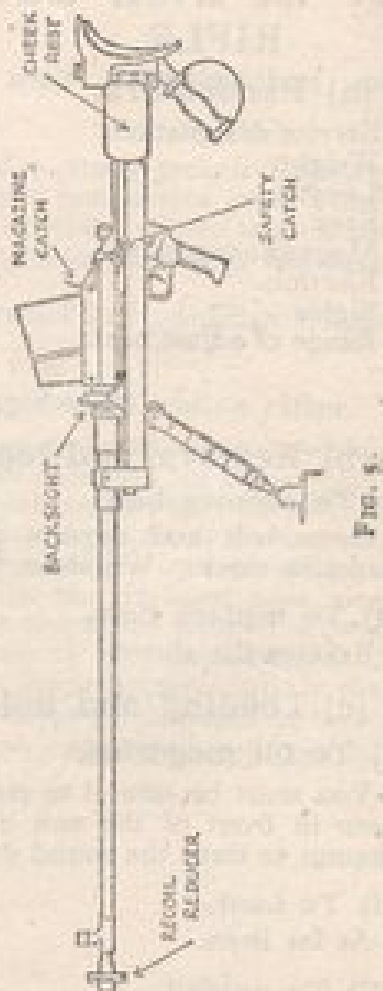

FIG. 5

CHAPTER II LIGHT MACHINE-GUNS

Preliminary.

A light machine-gun is an automatic weapon of rifle calibre which, in its primary rôle, does not require any form of mounting other than a bipod or similar support which is normally attached to it in all circumstances. It is capable of a reasonable amount of sustained fire, though, being air-cooled, its limit of endurance is not so great as that of water-cooled weapons. This, however, is sometimes offset by the possibility of changing the barrel in a matter of a few seconds.

Most light machine-guns are magazine-fed, as opposed to being belt-fed the capacity of the magazine varying with the type of weapon and with the task to be undertaken (e.g. magazines larger than normal are used on some weapons for A.A. fire).

Generally speaking a light machine-gun should possess the following virtues:

- (i) Lightness, combined with strength.
- (ii) Simplicity, and ease of stripping in the field.
- (iii) Ability to fire either in bursts or in a succession of single shots.

1. .303-INCH BREN L.M.G.

(a) Particulars.

Service designation.	.303-in. Bren, Mk. I and II.
Weight.	23 lbs.
Length.	45½ ins.
System of operation.	Gas-operated.
Locked or unlocked.	Locked by rising rear end of breech-block.
Method of feed.	Box or drum (A.A.) magazine, from above.

BREN LIGHT MACHINE GUN

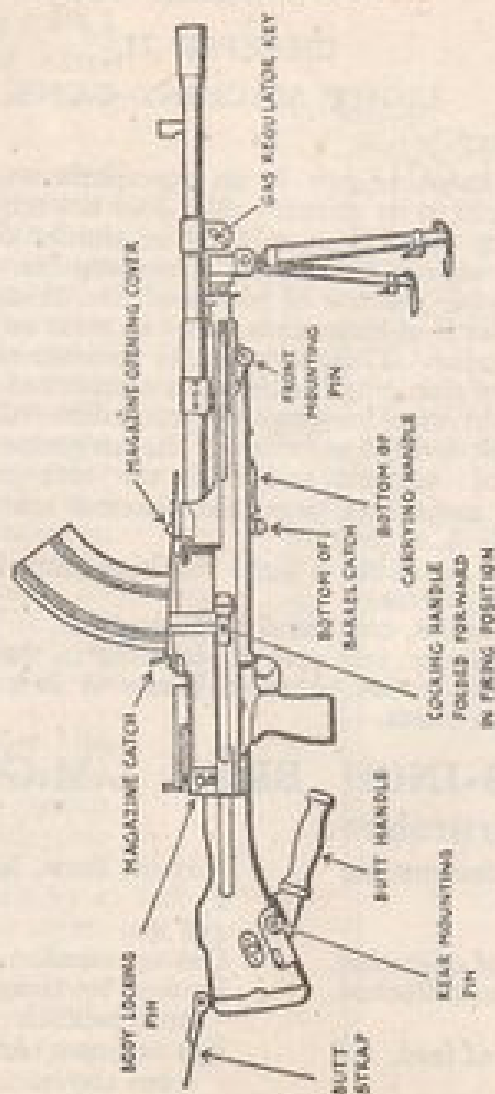

FIG. 6.

Magazine capacity.	Box, 30 rounds; drum (A.A.), 100 rounds.
Weight of magazines:	
Box: Full	2½ lbs.
Empty	17 ozs.
Drum: Full	12 lbs. 2 ozs.
Empty	6 lbs. 10 ozs.
Ejection.	Underneath.
Cocking-handle.	Right-hand side.
Condition of breech on:	
(a) Cease fire.	Open.
(b) Empty magazine:	
(i) Box.	Open. Moving parts held back by projections on rear of magazine platform.
(ii) Drum.	Closed.
Types of fire.	Automatic or single shot.
Speed of gun (cyclic rate).	450-550 rounds per minute.
Sights. Type.	Aperture.
Range of adjustment.	{ Mk. I, 200-2,000 (50 yds. clicks). Mk. II, 200-1800.
Ammunition.	Any .303 British Service.
Tripod (for use in rôle of Medium M.G.)	{ Weight, 30 lbs. Traverse limit, 42 degrees. Elevation limit, 19 degrees.

(See Fig. 6, p. 57).

(b) Loading and unloading.

(i) To fill the magazine (box type).

If you have a filler; clip the magazine into the mouth of the filler. Then see that the filling-lever is as far over to the left as it will go. Fill the hopper with about forty rounds. Thereafter push the filling-lever over to its right limit and

back to its left limit six times. This will put thirty rounds into the magazine. Do not hurry or jerk the filling movements. Six steady pushes and pulls are what is required.

If you have to fill by hand proceed as follows:

- (1) Holding the magazine in one hand, opening upwards and horizontal, front end towards you, place a cartridge on the magazine platform so that the cartridge is slightly in front of its final position in the magazine. Press the cartridge down with the thumb of the hand holding the magazine and push it backwards as far as possible with the other hand. Repeat with each round until the magazine is full.

Note. Normally, although the magazine will hold 30 rounds, only 28 will be inserted in order not to overstrain the magazine spring.

- (2) Care must be taken in loading to avoid getting the rim of any cartridge behind that of the cartridge next above it (i.e. inserted immediately before it) since this will cause a "rim over rim" stoppage.

Note. The easiest way of sorting out carton-packed ammunition which is packed head to tail is to grab as many rounds as you can in one hand, and then catch hold of as many bases as you are able with the other. You will find that all but one or two are sorted out.

(II) To fill the magazine (drum type).

Full instructions on the use and handling of the drum type (100-round) magazine will be found on the inside of the lid of the box containing the magazine equipment.

(III) To load.

1. If shut, push open the magazine opening cover.
2. Take the magazine in the right hand, mouth of the magazine downwards, insert the lip at the front end of the

mouth into the magazine opening, hooking it under the front end of the opening; lower the rear of the magazine until the magazine-catch engages on the rib on the magazine.

3. If forward, pull back the cocking-handle as far as possible and push forward again, folding it forward against the body.

(N.B. In Mark II guns the C-H does not fold).

4. Place the change lever (on the left of the body, just above the trigger) at SAFE—i.e. in a vertical position.

(IV) To unload.

1. Press the magazine-catch forward with the base of the palm of the hand, at the same time grasping the magazine and tilting it forward until clear of the magazine-catch. Lift off and place on ground or in pouch or box.
2. If at SAFE, move change lever to A (automatic).
3. Press trigger, cock gun, press trigger again.
4. Close magazine and ejection opening covers.
5. If on the range or undergoing elementary training, stand up and report "gun clear."

(c) Stripping and assembling.

(1) To strip.

1. See that the moving parts are forward.
2. Push body locking-pin out to the right as far as it will go. (This pin is in the top of the body just under the aperture of the backsight).
3. With left hand holding the backsight drum, pull back the butt group as far as possible with the right hand. The return spring rod will then be seen protruding forwards from the butt through the buffer.
4. Holding the return spring-rod to the left with the thumb of the left hand, pull the cocking-handle backwards sharply. This will slide the piston and breech-block out

LIGHT MACHINE-GUNS

of the back of the body. These can then be grasped and removed together from the gun.

5. Slide the breech-block to the rear until the claws at the front of it disengage from the grooves on the piston.

6. On the left of the gun, just in front of the magazine opening, will be seen the lever of the barrel nut. Press the spring catch on the underside of this and raise the lever as far as possible. This frees the barrel which may now be removed by moving it forward until clear.

7. The raising of the barrel nut lever also allows the butt group to be pulled farther back and removed from the body.

8. To remove the bipod from the body lift the front of the body with the right hand, and with the left hand pull the left leg of the bipod towards you as far as possible and then slide the bipod sleeve off the front end of the gas cylinder.

9. To remove the barrel nut, lift the lever as far as it will go and depress the small stud just in front of the magazine opening cover. (This may be done by easing the magazine opening cover forward so that it just covers the stud). The barrel nut may then be lifted out vertically. To replace push the barrel nut down into place with the lever as high as possible. It is usually necessary to press down the stud when replacing the barrel nut.

(II) To assemble.

Reverse the above, being careful to note the following points:

- (1) Make sure the bipod is fully home on the body.
- (2) See that the small stop on the left at the forward end of the butt group is in front of the barrel nut lever before lowering the lever. (Note. Mark I guns only.)
- (3) When replacing the barrel ensure that the long groove underneath, between the gas block and the

LIGHT MACHINE-GUNS

carrying-handle, engages with the stud on the top of the body. (Note. These are not present in the Mark II gun.)

- (4) See that the barrel nut lever is fully home and that the catch has engaged on the rib on the body.
- (5) Replace the breech-block on the piston by sliding the claws down into the grooves on the piston and as far forward as possible, and then letting the tail of the breech-block drop.
- (6) When replacing the piston and breech-block together see that:
 - (a) the butt group is fully to the rear;
 - (b) the breech-block is fully forward on the piston;
 - (c) the breech-block and piston are pushed right into the body before attempting to push forward the butt group.
- (7) When pushing forward the butt group make sure that the return spring rod engages in the recess made for it in the back of the piston.
- (8) To test correct assembly, cock gun, set change lever at A and press trigger.

(d) Additional stripping.

(i) To strip and assemble the breech-block.

1. Prise the extractor stay away from the extractor until it jumps out, being careful not to lose it. The extractor will then slide out. To replace, insert the extractor first and then the extractor-stay and spring, pushing the head of the stay well up behind the extractor.

2. With the nose of a bullet push out the striker retaining-pin from right to left, having first put a finger behind the tail of the striker to prevent it springing out. The striker and spring will then be free to slide out. When replacing note that the groove cut across the tail of the striker must be

outwards to enable the striker retaining-pin to be pushed back. Push the striker forward against the striker spring until the retaining-pin can be pushed home.

(ii) To remove and replace the gas regulator.

1. With the nose of a bullet push in the sliding catch in the regulator retainer on the right-hand side of the barrel until it is flush with both ends of the retainer.

2. Turn the gas regulator until the retainer is opposite the slot in the gas block; the regulator can then be removed to the left.

3. When replacing see that the sliding catch is flush with the ends of the retainer; insert regulator into the gas block, turn slightly and push out the sliding catch. Then adjust the regulator so that (a) the correct hole is in operation. (This is done by seeing that the appropriate punch mark on the left side of the regulator is opposite the punch mark on the gas block) and (b) one of the two cuts on the left side of the regulator is lined up with the horizontal cut on the gas block. (If this is not done the projection on the gun body will foul the regulator when you try to replace the barrel).

(e) Preparation for firing.

1. Dry completely the barrel, the face of the breech-block and the gas-affected parts (i.e. gas cylinder, gas regulator, piston and bipod sleeve).

2. See that the gas regulator is set correctly—the normal setting is the No. 2 hole (i.e. next to smallest).

3. Check assembly by working the moving parts.

4. See that the foresight is tight in its block.

5. Check magazine both before and after loading; before to see that the platform does not stick and that the spring is not damaged, after to ensure that it is correctly loaded.

(f) During firing.

1. Above the change lever (on the left of the gun just above the trigger) will be found the letters A.S.R. on the body. These letters correspond to the three possible positions of the lever and indicate that the mechanism is set for automatic fire, safety or single rounds respectively. This lever may be altered from any position to any other whether the moving parts are forward or back but must not be moved from Safe to Automatic whilst the trigger is pressed, or the gun will not fire.

2. If the gun becomes sluggish during firing it is an indication that more gas is probably needed. This is rectified by altering the gas regulator to the next largest hole.

(g) Points to note after firing.

1. Strip the gun and clean the barrel by first pouring water through it. Boiling water is best, but hot water will do, and even cold water is better than no water at all. Dry thoroughly and oil up.

2. Clean gas-affected parts by the application of plenty of oil to loosen the fouling. Give the oil a short time to soak in and then wipe clean and dry, finally oiling up. Never scrape fouling off if it can be removed by another method.

3. Be sure not to leave the gun cocked when putting it away—always press the trigger, and ease the working parts forward by hand to avoid unnecessary strain.

(h) Stoppages and immediate action.

1. A well cared for gun, with the gas regulator set at the correct hole (normally No. 2) will rarely stop except on account of an empty or a badly filled magazine.

2. In all cases of a stoppage the Immediate Action is:

(i) Pull back cocking-handle.

- (ii) Remove the magazine.
- (iii) Press the trigger.
- (iv) Examine magazine; if empty or badly filled change it.
- (v) Put magazine on and cock gun.
- (vi) Continue firing.

Note. Possible causes: empty magazine, badly filled magazine, misfire, bad ejection, hard extraction.

3. If, after the above sequence, the gun fires a round or two and again stops it is a sign that more gas is wanted and the Immediate Action is:

- (i) Carry out (i), (ii), (iii) and (iv) of paragraph 2.
- (ii) Cock gun (without magazine on).
- (iii) Release barrel, slide forward and change gas regulator to next largest hole.
- (iv) Replace barrel.
- (v) Put magazine on.
- (vi) Continue firing.

Note. Possible causes: insufficient gas, binding of moving parts due to heat or dirt.

4. If, after the sequence in paragraph 2, the gun will not fire it shows that some mechanical breakdown, either of the gun or the ammunition, has occurred and the Immediate Action is:

- (i) Carry out (i) and (ii) of paragraph 2.
- (ii) Examine gun for obstruction and if any is found remove it, replace any broken or damaged parts, and carry on as in (v) and (vi) of paragraph 2.
- (iii) If no obstruction is visible insert clearing plug in breech, press trigger, re-cock gun, thus removing the clearing plug and carry on as in (v) and (vi) of paragraph 2.

Note. Possible causes: broken part, damage to magazine lips, separated case.

(i) Points of interest.

(1) The tripod.

Originally each gun had its own tripod on which it could be used against either ground targets or aircraft. Recently, however, it has been decided that one tripod for every three guns is all that is necessary since the occasions on which it is desirable to use the gun as though it were a medium M.G. are considered to be becoming rarer and rarer.

As an A.A. mounting the tripod leaves a good deal to be desired, and there is now a tendency to abandon it as such and to fire at aircraft from the hip or from a recumbent position. This is quite feasible if tracer ammunition is available, but without such ammunition the problem of hitting a fast moving aircraft without any means of aiming makes this practice of extremely doubtful value, and the cause of a great and inevitable waste of ammunition.

(2) The spare barrel.

Each gun has a spare barrel which is carried in the spare parts holdall. After the gun has fired ten magazines at the rapid rate (about three magazines per minute) the barrels should be changed and every effort made to cool the hot one. If possible put the hot barrel in water but at the same time take care to avoid steam blast from the end of the barrel not immersed.

2. LEWIS LIGHT MACHINE GUNS OF THE FOLLOWING CALIBRES AND PATTERNS :

- i. .303-inch British (ground pattern).
- ii. .303-inch British (stripped pattern for A.A. use).
- iii. .300-inch U.S.A. (ground pattern).
- iv. .300-inch U.S.A. (stripped aircraft pattern modified in Britain for ground use).

(a) Particulars.

Since there are four types to be dealt with, the lay-out of this section will be slightly different to preceding ones. Only a few general particulars will be tabulated, most of the detail being covered in the general description.

Weight.—Ground guns.	28½ lbs.
Weight.—Stripped guns, U.S.A. and British— less bipod	} 20 lbs. approximately.
Length.—Ground guns.	
Length.—Stripped guns.	40-48 ins. depending on type of butt.
Feed.	Drum magazine actuated by the gun mechanism.
Capacity of magazine.	Two types—47 round, 97 round, both calibres.

Weight of magazine:	
Empty	47 rd., 1 lb. 12 ozs.; 97 rd., 2 lbs. 14 ozs.
Full	47 rd., 4 lbs. 2 ozs.; 97 rd., 8 lbs. 2 ozs.
System of operation.	Gas operated.
Locked or unlocked.	Locked by rotating bolt.
Ejection.	Right side.
Cocking-handle. British.	Right-hand side normally
U.S.A.	Left-hand side only.
Condition of breech on:	
(a) Cease fire.	Open.
(b) End of magazine.	Closed.
Types of fire.	Auto only. No single shot mechanism.
Rate of fire (speed of gun)	} 500-600 rounds per minute.
British U.S.A.	

(See Fig. 7, p. 69).

(b) General description of the above types.

I. BRITISH .303-INCH LEWIS

The gun is the same as was used in the last war and is probably well known to many of you. It has telescopic bipod legs, an aluminium radiator and a casing to assist in keeping the gun cool, normal type of butt and a graduated aperture backsight with range scale up to 2,000 yards. The cocking-handle can be situated either on the right or left-hand side according to the will of the firer. Magazines contain forty-seven rounds.

II. BRITISH .303-INCH STRIPPED LEWIS

A certain number of guns have been lightened for free-

hand A.A. shooting without the use of a mounting. The modifications made are as follows:

- (i) The gun has been stripped of its radiator casing and aluminium radiator.
- (ii) The butt has been shortened by about two inches.
- (iii) A forward hand-grip has been incorporated.
- (iv) A light steel guard has been supplied for the gas cylinder.

Most of these guns are employed on ships.

In addition a certain number of guns have been made up from spare and scrap components. These, in their finished state, are very similar in appearance to the ones described above. The butts of these may, or may not, be shortened.

Note to i and ii above. There are two types of British ninety-seven-round magazine. The earlier type, which is the Air Force

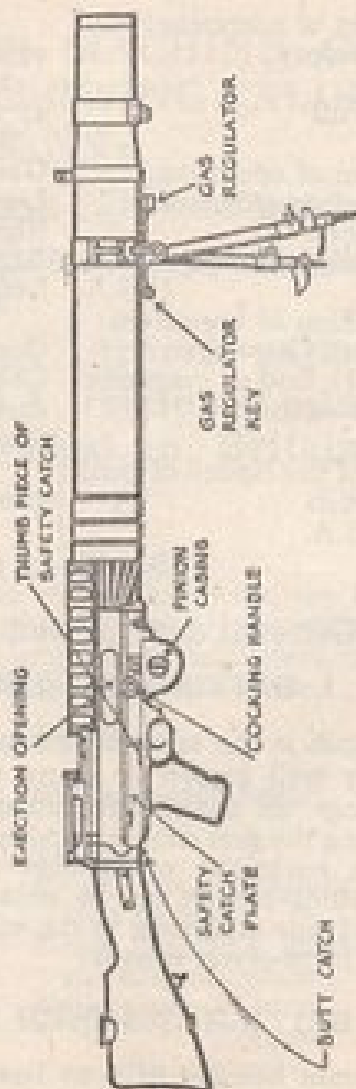

LEWIS LIGHT MACHINE GUN

FIG. 7.

pattern of the last war, requires an extension to the magazine post, since the catch is not long enough to engage in the post.

The later type, which has been brought into production in this war, has a long catch of similar type to the American pattern. Both these magazines, and the American ninety-seven-round ones, fit on the normal magazine post without any extension piece.

The later pattern magazines are easily distinguished by the greater length, or, if you prefer it, depth of the hook portion of the catch.

III. U.S.A. .300-INCH GROUND PATTERN LEWIS

This is almost identical with the .303-inch pattern. No separate description or particulars will therefore be given. It may be taken that instructions for the British Lewis cover this model, except in very minor particulars which will be obvious.

To distinguish it from the British pattern a two-inch red band is painted on the body in front of the magazine post.

IV. U.S.A. .300-INCH STRIPPED LEWIS (AIRCRAFT PATTERN MODIFIED)

This gun also has a red band painted on the body in front of the magazine post to denote the fact that it will not take the British Service cartridge. The figures .300 should be painted on this in black paint. Further, because the pinion casing, which contains the return spring, will not fit on a British Lewis although it looks almost exactly the same, it also is painted red.

These guns started life as aircraft observers' guns in U.S. planes. They came over here without sights, bipods, or radiator casings, and only spade-handle grips instead of butts. They are fitted with recoil reducers on the muzzles. There are both forty-seven- and ninety-seven-round magazines for these guns.

It has been laid down that U.S. magazines will also have

the rear half of the top of the centre disc painted red to distinguish them from British. The position of the painting assists in placing the magazine correctly on the gun.

There are two types of conversion for emergency ground use. The first few thousand had normal Lewis gun spare wooden butts fitted, instead of the spade grip. A ground battle-sight was fitted for a range of 400 yards. In view of the shape of the wooden butt and the consequent position of the head and eye, the line of sight could only be arranged to be sufficiently high to clear the forty-seven-round magazine.

Later consignments have been fitted with a skeleton butt with a wooden cheek rest. The shape of this butt was arranged to permit of the eye being in such a position that the line of sight clears the higher ninety-seven-round magazine.

Initially neither type of conversion catered for a bipod rest in view of the fact that these weapons are intended for the Home Guard only. It was intended that their normal method of use should be from behind prepared cover. Thus a simple wooden hand-grip was the only means of support provided. The weapons can either be rested on the cover on this hand-grip, and used in normal Lewis gun manner (this will be dealt with later) or used with the left hand forward on the hand-grip in the same way as a rifle. The two types of conversion can easily be distinguished by the butts—one is the normal wood butt and the other a skeleton butt which sticks out practically straight behind the gun. The points of difference in the two types are summarised in the following table:

1st Type.	2nd Type.
(a) Normal wood butt.	(a) Skeleton butt with wooden cheek rest.
(b) Low foresight and backsight set in A/A sight blocks	(b) High foresight and backsight set in A/A sight blocks

1st Type

(c) When employingsights only the forty-seven-round magazine can be used.

2nd Type

(c) Either a forty-seven- or ninety-seven-round magazine can be used when employing the sights.

Recently it has been decided that a proportion of these guns shall be fitted with a simple type of non-telescopic bipod. This fits on to the U.S.A. mounting yoke and, by means of a hook and chain which is attachable to the trigger guard, it can serve as a carrying handle if the gun is turned upside down. It is so arranged that, in this position, the portion which acts as the carrying handle is at the point of balance of the weapon. This applies whether there is a magazine on the gun or not.

AMERICAN MAGAZINES

The forty-seven-round magazine is similar to the British pattern. The ninety-seven-round magazine has an attachment to the catch and a short leather loop strap to facilitate removal of the magazine from the gun. It also has an indicator to show the number of rounds which the magazine contains at any time.

SIGHTS

All types have aperture sights. The battle sight provided for the stripped Lewis is also of an aperture type. Since with this sight, using a correct aim, you will hit what you aim at at 400 yards, you must aim down a little at the shorter ranges because the sight is a fixed one. Suggested simple aims are as follows:

- (i) At 400 yards aim at the centre of a man walking or at 6 o'clock at a man lying down.
- (ii) At 300 yards and shorter ranges aim at a man's knees. This is about eighteen inches low from the centre of the target. If he is lying down aim about one and a half feet into the ground beneath him.

(c) Loading and Unloading.**(i) To fill magazine.**

Put the loading handle in the socket. This releases the magazine catch and allows the centre block to rotate. Put the rounds in one at a time and turn the centre block as you go. Make sure that the groove in the base of the cartridge is engaged in the retaining plates in the magazine. If you have no loading handle press back the magazine catch by hand.

If you wish to use the round indicator on the ninety-seven-round American magazine, rotate the centre block until it reads two noughts before starting to fill.

(ii) To load.

1. See that the cocking-handle is forward.

N.B. On the U.S.A. Stripped Lewis this is on the left-hand side.

2. Place a magazine on the magazine post as follows:

- (i) British Lewis—Magazine-catch to the RIGHT.
- (ii) U.S.A. Lewis—forty-seven-round—Magazine as for British.

—ninety-seven-round—Magazine with the round indicator towards the firer.

3. Press the magazine down on to the post until you hear or feel the catch engage.

4. Rotate the magazine clockwise with a pull slap of the palm of the right hand (British), or a push slap with the left palm (U.S.A.). The reason for the difference is that you want to use the same hand both to rotate the magazine and operate the cocking-handle.

5. Pull back the cocking-handle. The gun is now loaded, with a round in the feed way, and bolt to the rear, ready to feed it into the chamber and fire it when the trigger is released

(iii) To unload.

(a) UNLOADING BY FIRING. Remove the magazine by pressing in the magazine-catch to the right. Raise the butt into the shoulder, release the trigger, cock the gun and again press the trigger.

(b) UNLOADING WITHOUT FIRING. (This will often be necessary when firing on the range.)

1. .303 guns. Remove the magazine. Press with any suitable object on the base of the round engaged by the feed arm, causing its nose to rise. Pull the round forward as far as possible. Then with one hand controlling the cocking-handle press the trigger and work the cocking-handle forwards and back once or twice until the round falls clear or can be removed by hand. Then carry on as in (a) above.

2. .300 guns. Owing to the length and contour of the cartridge the method described in 1 above is not practicable, and it is therefore necessary to proceed as follows.

After removing the magazine grasp the cocking-handle with the left hand, press the trigger with the right hand, and ease the moving part forward until the cartridge is clear of the feed arm and has just dropped into the bolt way. Then pull back the cocking-handle, apply the safety-catch to prevent accidents, turn the gun over on to its right side and the cartridge should then fall out or be capable of being removed with the fingers. Having removed it release the safety-catch and carry on as in (a) above.

Note. If you have a No. 2, i.e. an assistant for service of the gun, unloading should be done with the butt kept in the shoulder. The No. 1 (firer) presses in the magazine catch, No. 2 pushes up against the centre block of the magazine with his left hand, thus removing it from the post. No. 1 takes the magazine off with his right hand, still holding the butt in the shoulder with the left. The magazine is then passed under the gun to No. 2.

(d) Stripping and assembling.

This will be dealt with in three main groups as follows:

1. Piston group.
2. Body group.
3. Barrel group.

1. PISTON GROUP.

(i) To strip.

1. See that the gun is unloaded.
2. Press forward the catch on the underside of the front of the butt—use a screw-driver or coin or, on service, the nose of a bullet, if there is no thumb-piece to the catch. Only some of the British have thumb-pieces, while none of the U.S.A. pattern have them. Rotate the butt an eighth of a turn anti-clockwise and remove.
3. Press the trigger and withdraw pistol-grip slightly.
4. Pull back the cocking-handle and remove it by pulling it out to the right (British) or left (U.S.A.). Draw out the piston rod and bolt. Remove bolt complete. Unhook the pinion casing.

(ii) To assemble.

Reverse the above order.

Note:

- (a) When replacing piston and bolt, ensure that the feed arm is over to the left and the actuating stud fully screwed. If obstruction is felt, press back the tail of the ejector.
- (b) (i) The FEED ARM is the component which is hinged on the magazine post and moves sideways—to the left when the moving parts come to the rear and vice versa.
- (ii) The ACTUATING STUD is the pear-shaped stud at the top of the rear end of the bolt.
- (iii) The EJECTOR is the component on the inside of the body on the left, which rocks on a centre pivot.

2. BODY GROUP.

1. Body cover.

(i) To strip.

After the gun has been stripped as in A., proceed as follows:

- (i) Draw back body cover about half an inch and remove.
- (ii) Using the nose of a dummy round, or, on service, of a bullet, remove the cartridge guide.
- (iii) Remove stop pawl spring and stop pawls.

Note:

- (a) The CARTRIDGE GUIDE is the spring in the curved component on the front of the body cover.
- (b) The STOP PAWLS are the two arms supported by a leaf spring on the underside of the front of the body cover. The respective functions of these pawls is to stop over-rotation and rebound of the magazine.

(ii) To assemble.

Reverse the above order, ensuring that the stop pawls are placed on the correct posts. Posts and pawls are numbered both in British and U.S.A. type arms.

2. Feed-Arm.

(i) To strip.

Push back the feed-arm latch, move the feed-arm round to the right and lift it from the magazine post. Remove the feed-arm pawl and spring.

Note:

- (a) The feed-arm LATCH is the catch on the front of the feed-arm. This exists only on British guns. The U.S.A. type are without the latch.
- (b) The feed-arm PAWL and SPRING are situated half way along the top of the feed-arm. The function of this component is to push the magazine round as the feed-arm moves to the left.

(ii) To assemble.

Reverse the above order. If the piston and bolt are in the body the underside of the tail of the feed-arm must be placed over the actuating stud.

3. The Body.

(i) To strip.

1. Remove the body-locking pin.
2. Withdraw pistol-grip to the rear.
3. Unscrew body.

LIGHT MACHINE-GUNS

Note. The BODY-LOCKING PIN is the pin on the underside of the body which locks the body and barrel groups together. It can be eased out by inserting the nose of a dummy round or a bullet and pushing to the rear.

(ii) To assemble.

Reverse the above order.

3. BARREL GROUP

(i) To strip.

Ground pattern guns only.

1. Using the spare gas regulator key unscrew the clamp ring screw. Remove the clamp ring and front radiator casing.

2. Remove the bipod, the gas regulator key and gas regulator. Remove the rear radiator casing.

3. Unscrew the gas cylinder, using the piston rod if necessary. Remove the gas chamber and barrel mouth-piece with the spanner provided for the purpose.

Note. The barrel mouth-piece has a left-hand thread.

Stripped U.S.A. guns only.

1. Remove gas regulator key and gas regulator.

2. Unscrew gas cylinder and remove.

3. Unscrew inner chamber of gas regulator.

4. Unscrew recoil reducer.

Note. The recoil reducer has a left-hand thread.

(ii) To assemble—both types.

Reverse the above order.

(e) Additional stripping.

(i) Pinion Group.

1. Raise the pinion pawl, rotate the pinion if necessary and remove the tension screw. Remove the pinion from its

LIGHT MACHINE-GUNS

casing. Using a dummy cartridge remove the spring casing from the pinion.

2. Assemble in reverse order.

(ii) The Trigger Group.

1. Remove the sear axis pin, and remove the sear. Place one hand over the plunger and push out the trigger axis pin. Remove the trigger, the plunger and the trigger spring.

2. To assemble: Replace the trigger spring and the plunger. Keeping the plunger depressed, place the front end of the trigger bar into the slot in the plunger and replace the trigger axis pin. Place the dovetailed end of the sear behind the rear end of the trigger bar and replace the sear axis pin.

(iii) Ejector.

1. Remove the ejector cover. Place the point of a dummy cartridge in the hole under the left side of the body, press up the ejector and remove.

2. Assemble in reverse order.

(f) Points, before, during and after firing.

(i) Before firing.

1. Strip completely.

2. Clean and leave dry the gas-affected parts, i.e. barrel group complete.

3. Clean the remainder of the gun and slightly lubricate the working parts.

4. When assembling, set the gas regulator to the smallest hole (British gun) or No. 2 hole (U.S.A. type).

5. Adjust both return springs (the one on the gun and the spare one) to about 13 lbs., as follows:

(i) To INCREASE. With pistol grip disconnected, raise the pinion to connect with the ratchet on the piston and pull back the cocking-handle about two inches. This increases the weight by about 6 lbs.

LIGHT MACHINE-GUNS

- (ii) To DECREASE. With pinion disconnected pull back the cocking-handle a proportionate amount, raise the pinion to connect with the catch and push forward the pistol-grip. The cocking-handle flies forward and weight is taken off the return spring.

6. Clean and check spare parts and magazines.

(ii) During firing.

1. Unload.
2. Clean and lubricate working parts as necessary
3. Check ammunition and fill up any partly used magazines.

(iii) After firing.

1. Strip completely.
2. Clean and oil barrel.
3. Clean off all fouling from gas-affected parts, and oil up.
4. Clean and oil all other parts.
5. If not in the front line reduce weight of return springs to about 4 lbs.

Note. Gas fouling should not be removed by scraping. Use plenty of oil to soften the fouling, and, when this has had time to soak in, wipe the parts with a rag, when all the deposit should come away easily.

(g) Stoppages and immediate action.

If the return spring weight is correct and the gun is properly cared for, the Lewis gun will function well. Stoppages, however, sometimes occur and it is essential that the firer should instinctively carry out what is known as "Immediate Action" to get the gun firing again. Sometimes "Immediate Action" will not be successful, in which case a secondary action must be carried out.

A table of Immediate Action, generally known as I.A. and secondary action for use when I.A. has failed, is appended.

LIGHT MACHINE-GUNS

If the gun stops, other than when the pressure on the trigger is relaxed, it will do so with the cocking-handle in one of two positions, viz.:

1st Position: Cocking handle right forward.

2nd Position: Any position other than 1st, or fully cocked. These positions can, with practice, be recognised by feel.

LEWIS GUN STOPPAGES—IMMEDIATE AND SECONDARY ACTIONS TO BE CARRIED OUT.

Position of Cocking-Handle.	I.A. to be Carried Out.	If I.A. Fails, the Following Secondary Action to be Carried Out.
1st Position i.e., Cocking-handle right forward.	If gun fails to fire or commences firing and stops: Feel for the cocking-handle—try to rotate magazine, if it rotates, change it, if it does not rotate, cock the gun, aim and fire.	If after I.A. for 1st position the gun will not fire: Feel for cocking-handle—try to rotate magazine—if it does not rotate remove it and clear gun: (a) Examine feed-arm pawl and spring. If spring is broken change it—if not; (b) Change piston, load, aim and fire.
2nd Position.	If gun fails to fire or commences firing and stops: Feel for cocking-handle—cock the gun—try to counter-rotate the magazine—whether it counter-rotates or not, aim and fire.	(a) If, after applying I.A. for 2nd position, gun fires a few rounds and stops again: Feel for cocking-handle—cock gun—try to counter-rotate magazine—if magazine counter-rotates, change magazine, aim and fire. If magazine does not counter-rotate: Clear gun—take about 3 lb. off the return spring—load, aim and fire.

Position of Cocking Handle.	I.A. to be Carried Out.	If I.A. Fails, the Following Secondary Action to be Carried Out.
		<p>(Note. The gun should be cleaned at the first opportunity and the return spring re-adjusted to its normal tension.)</p> <p>(b) If, after I.A. for 2nd position, gun will not fire, there will always be a live round in the feed-way:</p> <p>Feel for cocking-handle—cock gun—counter-rotate magazine—remove magazine and examine inside the body and chamber:</p> <p>(a) If live round in chamber—clear gun—change magazine—load, aim and fire.</p> <p>(b) If empty case in chamber or body—clear gun—change the bolt—load, aim and fire.</p>

N.B. If you try to fire with the safety-catch applied, you will get a recurring third position stoppage. To rectify—pull back cocking-handle to cocked position, lower safety-catch and continue firing. You cannot lower the safety-catch when it is holding up the forward travel of the cocking-handle and piston under the influence of the return spring. *MORAL*—Do NOT forget to lower safety-catch before firing, should you have applied it.

General note on stoppages 1st or 2nd position.

If the gun stops at either 1st or 2nd position and there is *no resistance on the cocking-handle*:

Clear gun—change the pinion group—load, aim and fire.

3. .303-INCH HOTCHKISS LIGHT MACHINE-GUN

(a) Particulars.

Service designation.	.303-in. Hotchkiss M.G. Mk. I and II.
Weight.	27 lbs. approx.
Length.	3 ft. 10½ ins.
Method of feed and number of rounds	Metal strips holding 30, 14, or 9 rounds; metal-linked strip belt holding 50 rounds.
Weight of 30-rd strip:	
Empty	4½ ozs.
Full	1 lb. 15 ozs.
Weight of 50-rd belt:	
Empty	6½ ozs.
Full	3 lbs. 3½ ozs.
System of operation.	Gas operated.
Locked or unlocked.	Locked by rotating locking-nut.
Feed opening.	Right side.
Ejection.	Left side.
Cocking-handle.	In centre of rear of body.
Condition of breech on:	
(a) Cease fire.	Open.
(b) End of strip or belt	Open; piston held back by feed-piece.
Calibre.	.303 in.
Ammunition.	Any .303-in. British service.
Types of fire.	Single shot or auto.
Rate of fire (speed of gun).	500-600 rounds per minute
	(See Fig. 8, p. 83).

LIGHT MACHINE-GUNS

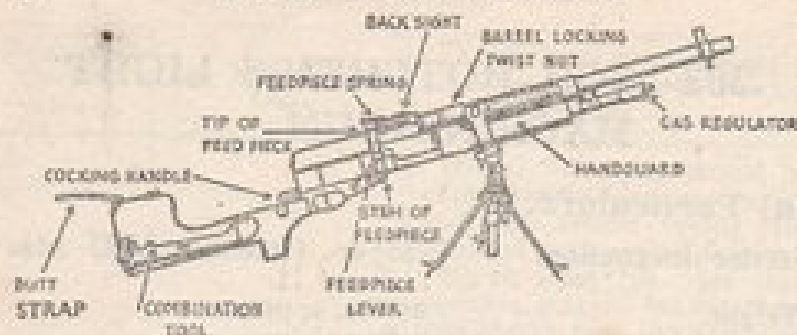

HOTCHKISS LIGHT MACHINE GUN



FIG. 8.

LIGHT MACHINE-GUNS

Note 1. The Mk. I gun cannot be used with a belt. The Mk. I^a gun can take either a strip or a belt. In the later Mark the slots in the feed guides are deepened to permit of the passage of the belt, which, on account of its hinges, is deeper than the feed strip. Bodies which have been converted to Mk. I^a have the words "Belt or strip feed" stamped on top of the body just in front of the backsight.

Note 2. When the belt is used, a carrier to hold it in position opposite the feed opening must be employed. This carrier consists of a clamp, which is fixed to the gun by means of side plates and nuts and bolts, and a cradle, which possesses a pan which can be swung down vertically out of the way when loading. The whole cradle can also be swung round forwards (anti-clockwise) when required.

Note 3. There is also a deflector bag fitting which was used in tanks in the 1914-1918 war to collect the empties. When used normally as a light machine-gun, the deflector bag is not a requirement. For special purposes it might come in useful.

(b) Loading, firing and unloading.

(i) To fill the strip or belt.

Force the cartridges between the clips until the rear face of the base of each cartridge rests against the front face of the continuous rib on the rear edge of the strip, or against the small raised rib in the same position on the belt.

Great care is necessary to ensure that the bases of all cartridges are in line and correctly positioned as indicated above.

Note 1. A filling machine exists. Early patterns only catered for the strip in the same way as the Mark I guns. Later patterns can fill either strip or belt and are so stamped on the name plate. Machines which do not clearly state that they are suitable for filling belts must be used only for filling strips.

Note 2. There is a resizing tool to enable the curvature of the centre row of clips on the strip to be restored when through use

or damage the clips do not properly retain the cartridges. The correct positioning of the cartridges depends on the proper contour and tension of the centre clips. The resizing tool rectifies strips which have slightly faulty centre clips.

The tool must *NOT* be used for resizing belts.

(ii) To load.

1. Turn cocking-handle up to the left as far as it will go and pull back sharply to the fullest extent—about six inches. It will be found to be best to use both hands on the cocking-handle while keeping the butt in the shoulder (there is a butt-strap) to provide leverage. You will both hear and feel the gun cock. Actually, when the C-H (cocking-handle) is pulled full to the rear, the moving parts are in rear of the cocked position, since the piston is held up by the lower arm of the feed-piece.

2. Push forward the C-H again, still keeping the lever slightly to the left of the vertical, and when it is *fully* home, turn the lever over to the right until one of the engraved lines ("A" for auto; "R" for repetition, i.e., single shots; "S" for safe) as desired is opposite the line on the guard.

3. Lift up the feed-piece out of engagement with the piston by pressing up the stem which projects below the body. The moving parts will then go forward under the influence of the return spring until the weapon is cocked on the bent of the piston and the sear.

4. Insert strip or belt as follows:

(i) *Strip.* With the rounds on the underside, push the strip into the feed opening of the gun, flat end of strip first.

Belt. Disengage the spring catch of the cradle and allow the pan to fall away. Holding the coiled belt in the right hand, pass the first unit (the six-round one) through the broad slot in the cradle into the feed opening; close up the pan until the catch engages and place the coiled belt in the pan.

- (ii) Lift up the feed-piece as before as far as it will go.
- (iii) Push strip or belt home until the toothed pawl on the feed-piece spring engages in the first slot on the near side of the strip or belt.

The gun is now fully loaded.

Note. Early belts were made up of seventeen units, the first sixteen holding three rounds each and the last two. Later patterns have only sixteen units, the leading unit being a six-round strip to facilitate loading.

(iii) To fire.

Press the trigger. The gun will continue to fire either single shots or auto (according to the setting of the C-H) until the strip or belt is empty. There is a projecting tongue on the right of the strip which enables the feed-piece, when the last round is fired, to perform its usual function of moving the strip over. The empty strip is thus ejected. There is a similar projection on the last unit of the belt.

(iv) To unload.

To unload a half-used strip proceed as follows:

- (i) Lift up the feed-piece to its highest position so that the feed-lever and the toothed pawl on the feed-piece spring are clear of their slots in the strip. You may have to raise the spring by means of the curved tail in order to clear the pawl.
- (ii) Withdraw the strip to the right.
- iii) Press the trigger.

(c) Stripping and assembling.

(1) To strip.

1. Turn C-H up to the left as far as it will go.
2. Draw C-H back about $\frac{1}{2}$ inch and turn over to right about 45 degrees. This clears the C-H from the piston.

LIGHT MACHINE-GUNS

3. Withdraw C-H to the rear.
4. Unscrew locking-screw on left of body three turns by means of its lever.
5. Holding the body of the gun with left hand, grasp butt with the right, and push butt forward about $\frac{1}{2}$ inch; lever butt downwards from the rear and remove to the rear.
6. Withdraw recoil spring from body.
7. Insert C-H in the piston at an angle of 45 degrees to the right (as when removing), turn it back to slightly left of the vertical and withdraw piston and breech-block.
8. Clear C-H from piston as before.
9. Remove breech-block from piston.
10. Remove firing-pin from breech-block.
11. Remove feed-piece-spring by first disengaging it from the button on the feed-piece, and then lifting and pulling it out to the rear.
12. Remove feed-piece as follows:
 - (i) Open feed-piece cover on right side of body by pulling knob outwards.
 - (ii) Lift leaf of backsight and turn over on its back.
 - (iii) Lift feed-piece to highest position and rotate to left through 180 degrees until feed lever points to rear.
 - (iv) Remove by lifting to the rear and upwards.
13. Using slot on combination tool, remove ejector by unscrewing ejector cap.
14. Remove barrel as follows:
 - (i) By means of combination tool rotate locking-nut of barrel to right until left side of claw is in line with scribed line on body.
 - (ii) Withdraw barrel to front.
15. Remove handguard by turning barrel locking-nut back a little to clear.
16. Unscrew and remove barrel locking-nut.

LIGHT MACHINE-GUNS

17. Insert a forefinger in the barrel recess of body and pull out to front the action locking-nut. This nut is known as the "fermeture nut."

18. Using the hand extractor remove extractor-spring and extractor from breech-block by inserting claw of tool between the two rear coils of spring, compressing spring slightly, and levering outwards.

Note. The extractor-spring or extractor can be changed when the gun is assembled. Use an empty case sideways in the ejection opening at the front end to keep the breech-block from being fully closed. Lever the breech-block forward gently on to the empty case by means of the C-H, and change damaged component.

(II) To assemble.

1. Reverse the above from 18 to 9 but remember that:
 - (i) the fermeture nut must be replaced with the flat end to the front.
 - (ii) The locking nut is ready for assembly of handguard and barrel after the claw has passed over the serrated stud once only.
 - (iii) The round stud on the locking-nut must clear the handguard and then be turned down to receive the barrel.
 - (iv) Before assembling piston and breech-block the fermeture nut must be turned to the open position by inserting the forefinger of your left hand through the ejection opening. The nut is in the open position when the slot in the nut and the ejection opening coincide.
 - (v) The firing-pin must be turned over to the left in the breech-block before the latter can enter the body.
 - (vi) The piston will be held up on the feed-piece. The latter must be raised to allow the piston to pass by.

LIGHT MACHINE-GUNS

2. To assemble recoil spring, butt group, and C-H proceed as follows:

- (i) Insert recoil spring in its recess in the piston.
 - (ii) Put front end of C-H through its hole in the butt group and leave about $1\frac{1}{2}$ inches protruding.
 - (iii) Holding C-H in this position by grasping C-H and butt together, place the protruding end of the C-H inside the recoil spring.
 - (iv) Now reverse (5) of "Stripping."
 - (v) Complete assembly of C-H by pushing forward with lever at 45 degrees to the right; when it comes to a stop, turn up to slightly left of vertical; push completely forward and turn down to the right.
3. Screw up body locking-screw.
 4. Set C-H at "A" or "R" and pull trigger.

(d) Preparation of the gun for firing.

1. Normal points concerning cleaning, lubrication, and hand testing of the mechanism to be carried out.
2. The gas regulator should be set normally at 25. Screwing in the regulator increases the gas and vice versa.

(e) Stoppages and Immediate Action.

No.	Position of breech-block.	Other Symptoms.	Probable Cause.	Remedy.
1.	Any position.	—	Bad introduction of strip.	Cock, push strip home, re-try, etc.
2.	Any position.	Frequently recurring stoppage.	Lack of gas or excessive friction.	Cock gun, set C-H at "R," screw up gas regulator 3 divisions and carry on.
3.	Home.	—	Misfire, hard extraction, or space in strip.	As for No. 1.
4.	Back from chamber.	—	Bulged or damaged round.	As for No. 1.
5.	Forward and locked.	If, on pulling trigger, gun does not fire.	Barrel locking-lut loose.	Unload, ensure barrel is home, tighten up nut, reload and carry on.
6.	Forward but not locked.	If, on pulling trigger, gun does not fire.	Fitting or loose case in furniture out or cam groove of piston.	Unload, strip gun, and investigate, re-load and carry on.
7.	Back.	Breech open with live round bearing down on empty case.	As for No. 2.	Clear obstruction, apply remedy No. 2, and clean thoroughly when possible.
8.	Partly forward.	Live round partially fallen down from strip.	Defective strip.	Cock gun, apply safety, remove round, change strip and carry on.

Note. Both the firing-pin and the extractor are very robust and will normally give no trouble, but should they require changing through breakage, a broken firing-pin will give Stoppage No. 3, while a broken extractor stoppage will produce symptoms as in Stoppage No. 7.

4. VICKERS-BERTHIER LIGHT MACHINE GUN

(a) Particulars.

Service designation.	.303-inch Vickers-Berthier.
Weight.	22 lbs.
Length overall.	45½ ins.
Feed.	Vertical box magazine, Bren type.
Capacity of magazine.	30 rounds.
Weight of magazine:	
Empty	12 ozs.
Full.	2 lbs. 7 ozs.
System of operation.	Gas operated.
Locked or unlocked.	Locked by rising rear end of breech-block.
Feed opening.	Top.
Ejection.	Right side.
Cocking-handle.	Right-hand side.
Condition of breech on:	
(a) Cease fire.	Open.
(b) End of magazine.	Open; held up on breech-block catch.
Calibre.	.303-inch.
Ammunition.	Any .303-in. British service.
Types of fire.	Single shot or auto
Rate of fire (speed of gun).	500-600 rounds per minute.

(See Fig. 9, p. 92).

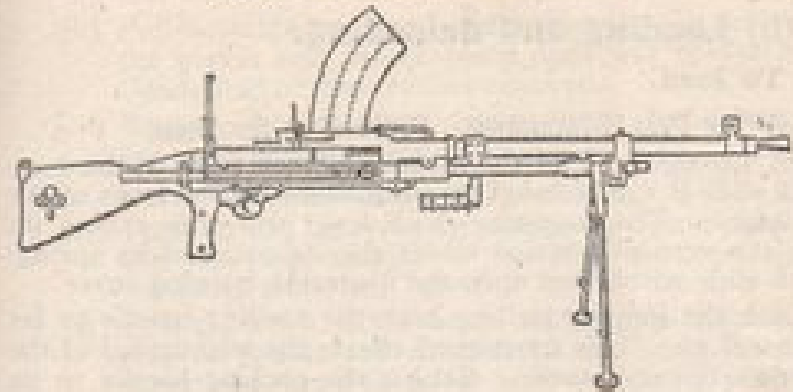

VICKERS - BERTHIER L.M.G.

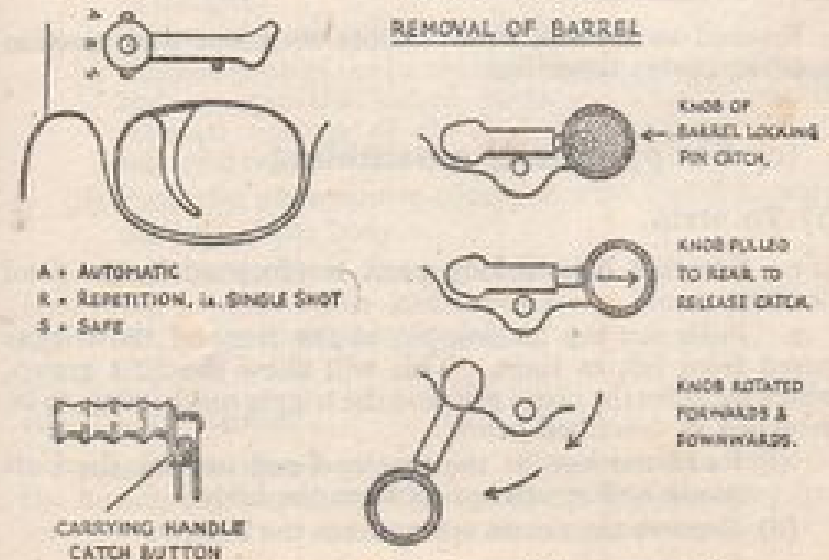

Fig. 9. www.vickersmachinegun.org.uk

(b) Loading and unloading.**(i) To load.**

(a) **TO FILL MAGAZINE.** Proceed as for Bren.

(b) **LOADING.** Pull the magazine-catch slide to the rear. This slide is the rectangular component just in front of the backsight. The magazine-catch lever will then spring up into the vertical position under the influence of its spring. With slide withdrawn open the magazine opening cover.

Cock the gun by pulling back the cocking-handle as far as it will go. This movement effects the withdrawal of the ejection opening cover. Return the cocking-handle to its forward position.

Place a full magazine on the gun in the same manner as for the Bren.

(ii) To unload.

Proceed as for the Bren. Close magazine and ejection opening covers thereafter.

(c) Stripping and assembling.**(i) To strip.**

1. See that the working parts are forward in the fired position.

2. Push out the locking-pin at the front of the trigger guard from left to right. This will allow the butt group, which includes the pistol grip and the trigger mechanism, to be detached as described below:

- (i) Raise the butt at the rear end and unhook the butt group and return spring from the body.
- (ii) Remove the return spring from the butt.

(iii) Pull back the cocking-handle sharply; this will bring the piston and breech-block back out of the body. Catch hold of them as they come out.

(iv) Remove breech-block from piston by drawing it forwards and upwards.

3. Remove barrel as follows:

(i) Press in the carrying handle catch button and turn the carrying handle to its highest position, i.e. vertically above the barrel.

(ii) Pull the knob of the barrel locking-pin catch to the rear to release the catch from the body, and turn down and forwards as far as it will go. This action disengages the gas cylinder from the barrel.

(iii) Holding the carrying handle, rotate the barrel over to the right, thus disengaging the threaded portion from the body, and push the barrel forward and out of the gun.

4. Remove the gas cylinder as follows:

(i) Pull the knob of the barrel locking-pin catch backwards and up into the locked position. This brings the serrated portion of the barrel locking-pin out of engagement with the gas cylinder.

(ii) Push the gas cylinder complete with bipod forwards and out of the body.

5. Pull the knob of the barrel locking-pin catch to the rear; turn it downwards and forwards as when removing the barrel, and withdraw to the left.

(ii) To assemble.

Reverse the above procedure. Remember to assemble the breech-block to the piston before putting the latter back into the gun.

LIGHT MACHINE-GUNS

(d) Preparation of the gun for firing.

1. Normal points concerning cleaning, lubrication, and hand testing of the mechanism to be carried out. Be especially careful to wipe all oil off the gas-affected parts. To leave oil on them merely increases liability to fouling in the gas block, etc.

2. In the Mark I gun there are four settings for the gas regulator, viz.: 0, 1, 2, and 3. Setting 0 cuts out the gas entirely. Of the others, 1 is the smallest and 3 the largest hole. To prepare the gun for firing set the regulator at 2. If sluggish in action increase to 3; if violent decrease to 1. The Marks II and III guns have different types of gas blocks. I have not seen them, but inspection and common sense will shew you what to do. A safe rule is always to start off at a medium hole and alter if necessary.

(e) Stoppages and immediate action.

If the gun stops firing, the breech-block will be found to be in any one of four positions, viz.:

- (i) Forward and right home.
- (ii) Not quite home.
- (iii) About half the breech-block, from the rear of the extractor forwards, visible in the ejection opening.
- (iv) About one-third of the breech-block, i.e., front portion only of the extractor, visible in the ejection opening.

In the event of a stoppage occurring, the cocking-handle, with one exception, gives no indication of the cause of failure. The position of the breech-block therefore is the guiding factor in deciding what type of immediate action to apply. Hence the FIRST IMMEDIATE ACTION IS TO NOTE THE POSITION OF THE BREECH-BLOCK.

No.	Position of breech-block	Symptoms	Probable cause.	Remedy
1.	Fully forward.	Round in chamber.	(a) Minder of. (b) Possibly cocking handle not fully forward after cocking.	Pull back cocking-barrel, push right forward and continue firing.
2.	Fully forward.	Stoppage as in 1, occurs after L.A.	Something wrong with breech-block or firing pin.	Change breech-block and continue firing. N.B. Where opportunity offers examine defective breech-block and change firing pin if damaged.
3.	Fully forward.	Nothing in chamber.	(a) Failed to feed, or (b) Failed to remain open after last round in magazine.	(a) Cock gun and continue firing. (b) Change empty magazine, let fall one.
4.	Fully forward.	Stoppage as in 3(a) occurs after L.A.	Weak magazine spring.	Change magazine.
5.	Not quite home.	Round in chamber but not gripped by extractor.	(a) Slight fault in feed. (b) Rear portion of round bulged.	(i) Cock gun. (ii) Pick round back into feed-way either by tipping gun to right or by using extractor with screw-driver tool. N.B. Use strap of magazine carrier if necessary when cocking after (b).
6.	Not quite home.	Stoppage as in 3, occurs after L.A.	Weak magazine spring.	As for 3 above but in addition change magazine.
7.	Not quite home.	Stoppage continues after L.A. in 6 applied.	Separated case.	Remove clearing plug and remove separation.

(f) Particulars of interest.

The Mark I gun was the earliest pattern. Subsequently certain improvements were made; some of these are incorporated in Mark II guns, while all are included in the present pattern, which is the Mark III. The improvements are as follows:

- (i) A simple form of muzzle brake (recoil reducer), which also acts as quite an efficient flash reducer.
- (ii) A redesigned gas plug (already mentioned), which, to a large extent, is self-clearing of fouling.
- (iii) Alteration to the piston and breech-block to give better support to the rear end of the latter.
- (iv) Incorporation of a recoiling movement of the body in the receiver on much the same lines as the Bren.
- (v) Simplified trigger mechanism.

Note. The new types of piston and breech-block are designated Mark II. *A Mark I piston cannot be mated with a Mark II breech-block and vice versa.* The complete assembly of Mark II piston and Mark II breech-block can, however, be fitted into Mark I guns. This substitution of later components is in fact being carried out on all Mark I guns which come into Ordnance for factory repair or other reasons.

8. Half visible.	Round half in and half out of chamber.	Round lodged at forward end.	Cock gun and remove round if left in feed-way.
9. Half visible.	Empty case in chamber; live round in contact with base of empty case.	Broken extractor.	(i) Remove magazine. (ii) Cock gun. (iii) Remove half-fed round from magazine. (iv) Change breech-block or extractor if no spare breech-block available. (v) Clear fired case by cocking after re-assembly.
10. Half visible.	Empty case on face of breech-block, or in feed-way. Live round trying to enter chamber.	Failure to eject.	(i) Remove magazine. (ii) Cock gun. (iii) Remove half-fed round and empty case from body. (iv) Replace magazine and continue firing.
11. Half visible.	Stoppage as in 10, occurs after L.A.	Broken ejector or weak extractor spring.	(i) As for 10, (i), and (ii). (ii) Examine ejector and change if necessary. H.O.K. (iii) Change breech-block or extractor spring.
12. One-third only visible.	Empty chamber. Round only just displaced in magazine.	Failure to feed due to: (a) Rim behind rim; (b) Friction, i.e. dirt, dust sand, etc., in gun or magazine.	(i) Cock gun and fire. If repressed, (ii) Change magazine. If recurring, (iii) Clean mechanism at first opportunity. N.B. If due to sand do NOT oil up. Leave mechanism dry.

5. GERMAN 7.92 mm. M.G. 15 (Aircraft observer's gun)

(a) Particulars.

Service designation	German M.G. No. 15
Weight.	15½ lbs.
Length overall	42½ ins.
Feed	Magazine; saddle drum type.
Capacity of magazine.	75 rounds.
Weight of magazine:-	
Empty	5½ lbs.
Full.	9½ lbs.
System of operation.	Recoil.
Locked or unlocked.	Locked by rotating threads at rear of bolt.
Feed opening.	Top.
Ejection.	Underneath.
Cocking-handle.	Right-hand side
Condition of breech on:	
(a) "Cease fire."	Open.
(b) End of magazine	Closed.
Calibre.	7.92 mm.
Ammunition.	Rimless, German service 7.92 mm. cartridge.
Length of barrel recoil.	0.8 in.
Types of fire.	Automatic only.
Rate of fire.	1,000-1,100 rounds per minute.
Other particulars:	Pistol grip and trigger; no deflector bag fitted, detachable.
	shoulder piece; mounted on ball gimbal in aircraft.

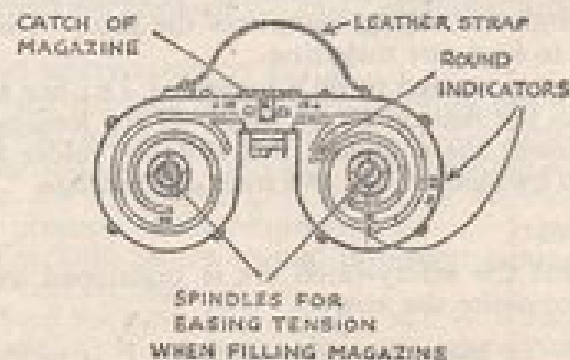
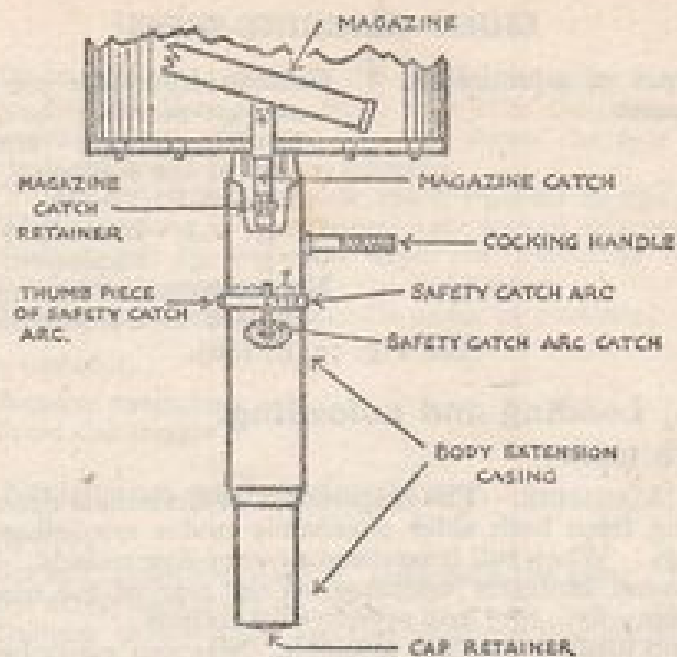

GERMAN M.G. 15.

Types of ammunition used.

German Luftwaffe use solely armour-piercing or semi-armour-piercing ammunition of the following types:

Semi-A.P.	Tracer.
" "	Incendiary.
" "	Explosive.

No common ball ammunition is used in German aircraft.

(See Fig. 10, p. 100).

(b) Loading and unloading.

(i) To load.

(a) **MAGAZINE.** The magazine is of the saddle drum type feeding from both sides alternately under the influence of springs. When full it contains seventy-five rounds. There are round indicator openings in the rear of the magazine at twenty-five, fifty and seventy-five rounds.

If no loading keys are available, these can easily be made out of suitable diameter tubing with slots cut in the end to fit the bars in the magazine spindles. A small tommy-bar inserted through the tubing completes the job. Two keys are required to load one magazine.

Three men are wanted to fill a magazine, i.e., one to hold it, one to take the tension off by means of the loading keys, and one to insert the rounds. If a suitable holder for the magazine can be mocked up, two men can manage.

(b) **LOADING:**

- (i) See that the safety-catch arc is positioned with the "F" opposite the arrow.

N.B. To move the safety-catch arc it is necessary to depress the safety-catch arc retaining catch slightly before rotating the arc.

- (ii) Place a full magazine on the gun in the same manner as for the Bren, i.e., front end into the magazine opening first, and then pressing down the rear end until the magazine catch engages.
- (iii) Throw over the magazine catch retainer to the left. The magazine is now completely locked in position and cannot be removed until the magazine catch retainer is pushed over to the right again.
- (iv) Pull back the cocking-handle as far as possible.
- (ii) To unload.
1. Remove magazine.
 2. Press the trigger.

(c) Stripping and assembling.

(i) Stripping.

1. Set safety-catch arc at "F" and cock the gun.
2. Set safety-catch arc at "S."
3. Depress safety-catch arc retaining catch slightly and at the same time rotate the body extension group anti-clockwise rather less than a quarter of a turn, and pull to the rear. This removes the body extension group from the body.
4. Set safety-catch arc to "F."
5. Place the face of the bolt, pointing downwards, on a piece of soft wood or other soft object of a firm nature, and press the trigger, at the same time exerting a downwards pressure on the pistol grip, in order to counteract the upward pressure of the return spring.
6. The bolt, return spring, firing-pin guide, and firing-pin can then be removed.
7. Place the nose of a blunted nail or a suitable punch in the hole in the centre of the large screw cap at the rear of the gun (body extension group) and give a sharp blow in the direction of the axis of the gun. This releases the

serrations of the cap retainer and cap and allows the latter to be unscrewed.

8. Holding the front end of the body extension downwards, unscrew the large screw cap and remove.

9. Lift out cap retainer.

10. Press the trigger and withdraw the trigger guard about one and a half inches to the rear and remove.

N.B. It may be necessary for the trigger guard to be tapped gently back with a raw-hide mallet. Do NOT use a hammer or other steel object.

11. Withdraw body extension casing to the rear and take out the buffer and buffer spring.

12. Returning to the barrel and body groups, remove barrel, barrel extension, and locking-nut from the barrel casing.

N.B. To do this you must first lift up the ejector to its fullest extent and keep it up while the barrel, etc., is being withdrawn. The ejector will be found at the rear of the magazine opening.

13. Remove muzzle attachment by raising detent and unscrewing.

14. Remove the choke, if necessary tapping it off with a raw-hide mallet.

Further stripping should be unnecessary, but if required, it must be done only by an armourer.

(ii) Assembling.

1. Replace choke and muzzle attachment.

2. Re-assemble barrel, barrel-extension and locking-nut in barrel-casing.

N.B. See that the wider slot in the barrel extension is uppermost.

3. Replace body extension in body extension casing.

4. Replace buffer, cut-away slots to the front, ensuring that the guide studs on the inside of the buffer enter the cut-away portions of the body extension.

5. Insert buffer spring and withdraw buffer and spring until the rear end of the latter is flush with the rear end of the body extension.

6. Replace trigger guard and push forward.

N.B. Do NOT press trigger.

7. Insert cap retainer in the rear end of the body extension. See that the two nipples seat themselves in the two slots of the latter.

8. Hold body extension with forward end downwards, replace large screw cap and screw up. Retainer and cap are automatically locked by the pressure of the return spring and the ratchet teeth on both components.

9. Replace extractor.

10. Replace firing-pin.

11. Insert firing-pin guide in breech-block, so that the long arm of the cocking-lever is in the recess in the base of the cocking-handle.

12. Place the return spring over the firing-pin guide and place the whole assembly of return spring, firing-pin guide, and breech-block in the front end of the body extension casing.

13. Holding these components together with the left hand, place the front end of the breech-block vertically downwards on a piece of wood, and push the trigger guard and body extension hard down until you hear or feel the breech-block cock on the sear.

14. Rotate the safety-catch arc to "S" position.

15. Insert body extension group complete in barrel casing (to which the barrel has already been assembled) and rotate until safety-catch arc catch engages.

16. Rotate safety-catch arc to "F."

17. Press the trigger.

(d) Stoppages and immediate action.

In the event of a stoppage apply the following immediate action:

- (i) Cock the gun.
- (ii) Remove the magazine.
- (iii) Press the trigger.
- (iv) Examine magazine mouth—if rounds correctly placed.
- (v) Replace magazine.
- (vi) Cock gun.
- (vii) Continue firing.

If at (iv) above a round is misplaced, i.e., half out of the magazine, remove it, replace magazine and carry on as indicated. If the stoppage persists, change the magazine. If similar stoppages still continue, strip and clean the mechanism, examine for burrs, damaged or broken components, and oil up.

(e) Special features and general information.

The easiest and most suitable manner of utilizing this weapon is to fix it on to a "Mounting seat A.A." (Motley Mounting). If no other means are available you can manage quite well by tying the barrel casing and pistol grip to the front and rear Bren supports of the mounting arm. I did this myself in France and it functioned quite well.

Using the gun in this manner, its high rate of fire, which makes it an ideal weapon for A.A. purposes, is employed to the best advantage. At the same time it releases an extra Bren for ground defence.

If you run out of captured ammunition, Royal Armoured Corps 7.92 mm. ammunition is of the same calibre and size, and can be used in lieu.

6. 7.92 mm. GERMAN L.M.G. 34.**(a) Particulars.**

Weight.	26 lbs. 2 ozs.
Length.	48 ins.
System of operation	Recoil operated.
Locked or unlocked.	Breech bolt locked to barrel by interrupted threads on bolt head.
Method of feed.	Metal belt (for details see below), fed from left-hand side.
Belts.	Capacity 50 rounds. Metal links joined by coiled wire. The first link in each belt has an opening into which fits a small tag on the end of each belt so that belts of any multiple of 50 rounds may be made up.
Ejection.	Underneath.
Cocking-handle.	Right-hand side.
Condition of breech on:	
(a) Cease fire.	Open.
(b) End of belt.	Closed.
Sights.	Open. A form of optical sight is also carried for use with the tripod.
Range of adjustment.	Open sights, 200-2,000 metres Optical sight, 0-3,000 metres.
Types of fire.	Automatic or single shot.
Speed of gun.	800-900 rounds per minute.

Note. Two variations of the M.G. 34 have recently come to notice.

- (a) M.G. 34.S. Externally this is very similar to the M.G. 34, but a certain amount of simplification of the working parts has been carried out, probably with a view to assisting production. Rate of fire is the same as for the M.G. 34.
- (b) M.G. 34/41. This gun is shorter than the M.G. 34, has a heavier barrel and a higher rate of fire which is in the neighbourhood of 1,000 rounds per minute. The working parts are almost identical with those of the M.G. 34.S.

(b) Loading and unloading.

(i) Belt filling.

This is simply a matter of pushing cartridges into the clips until the nib at the end of each clip engages in the groove round the base of the cartridge.

(ii) To load.

The belt is fed into the gun from the left and so that the belt is on top of the cartridges. To load slide forward the cover catch (just in front of the gun butt) and lift the cover.



GERMAN M.G. 34

FIG. 11.

Place the belt in the belt guide so that the right hand cartridge is against the stop on the right side of the guide. Close the cover and pull back the cocking-handle. The gun is now ready to fire.

Note. When closing the cover always ensure that the rib on the feed-actuating-arm is engaged with the slotted stud at the rear of the breech-bolt carrier.

(iii) To unload.

Push forward the cover catch, open the cover and remove

the belt. Press the trigger. Close the ejection opening cover.

Note. The ejection opening cover is hinged on the left side of the ejection opening and springs open as soon as the trigger is pressed.

(c) Stripping and assembling.

(i) To strip.

1. Open the cover, lifting it to a vertical position, press on the right-hand end of the cover hinge-pin and lift off the cover, taking care not to let the feed block slide off.

2. Press up the protruding catch on the under side of the body (about 3 inches in rear of the pistol grip) and with the other hand twist the butt one quarter turn anti-clockwise and allow the return spring to force it out of the back of the body under control. Remove the return spring.

3. Pull the cocking-handle back sharply, taking care that the bolt and bolt carrier do not fly out of the back of the body. Remove bolt and bolt carrier.

4. Depress the catch on the left of the gun just below and in rear of the back sight, and twist the body anti-clockwise out of alignment with the barrel. Remove the barrel from the barrel casing.

5. To remove the body from the barrel casing, take the body in the right hand and with the left hand press up the body hinge-pin catch (which is on the underside of the barrel casing on the right-hand side about $1\frac{1}{4}$ inches from the rear of the casing) twist the body anti-clockwise until it has completed a half turn from the fully closed position and withdraw it.

6. To remove the barrel mouthpiece lift the catch in front of the foresight and unscrew. Remove the mouthpiece and the cone inside it.

7. To remove the bipod press up the catch on the under-

Note. The foresight must be raised before this can be done.

side of the barrel casing just behind the bipod and twist the latter in either direction until the semi-circular slide is free of the guides.

(H) To assemble.

Reverse the above procedure paying attention to the following points:

- (i) In attaching the body to the barrel casing hold the body inverted, press in the body hinge-pin catch and push the hinge-pin fully home, then release the catch and, easing the hinge-pin out of its socket slightly, turn the body clockwise until the catch snaps home.
- (ii) Do not forget to insert the barrel before twisting the body home into line with the barrel casing.
- (iii) See that the rollers on the bolt are in line with the lugs on the bolt carrier and that the ejector is forward before inserting in the body. Press the trigger and ease the bolt and carrier forward.

Note. The ejector is a pin, running through the bolt, at an angle from the face of the bolt to a position just above the right hand pair of rollers.

(d) Additional stripping.

1) The buffer group.

Is removed from the butt by pressing the catch on the underside of the butt and twisting the buffer group a quarter turn in either direction.

(ii) To separate the bolt from the bolt carrier.

1. Twist the bolt so that it slides into the carrier and so that the trigger lever is tripped and the firing-pin spring released.

Note. The trigger lever is situated just in rear of the right-hand pair of rollers on the bolt and is tripped by being driven over a sloping surface on the bolt carrier and forced outwards.

2. Pull back the grips on the cocking-piece and unscrew

it from the firing-pin. The bolt and carrier may now be separated.

3. When assembling be sure that the cocking-piece is fully home and then twist the bolt until the rollers are in line with the lugs on the carrier.

(iii) To remove the cocking-handle.

Press the catch under the rear of the body, pull back the cocking-handle as far as possible and ease the front end out of its groove. When clear a further backward movement will release it entirely. To assemble reverse the process.

(iv) The feed block.

Is removed from the cover by setting the slide half-way and slipping the block forward off the cover. The feed slide then slips out of the feed block. The actuating arm and lever may then be removed from the cover.

(e) General information and points of interest.

1. BELTS. Although the normal belt is that described under para. (a) above, it is possible to use the M.G.17 belt with this gun.

2. To adjust in order to obtain smooth working the barrel mouthpiece is unscrewed or screwed up. This varies the size of the expansion chamber formed by the cone and consequently the violence of the recoil.

3. For single shots the upper part of the trigger (marked E) should be pressed, for automatic fire the lower part (marked D) is used.

4. A number of ingenious contrivances have been incorporated in this weapon which will become apparent on inspection. Such points as the method of sight adjustment for differences of 100 metres, the method of attaching the sling to the pistol grip and the method of securing the bipod legs when folded against the barrel casing are worth noting.

7. 7.92 mm. GERMAN M.G.42.

(a) Particulars.

Weight.	23½ lbs.
Length.	48 ins.
System of operation.	Recoil operated.
Locked or unlocked.	Breech bolt locked to barrel by roller wedges.
Method of feed.	} As for M.G.34.
Belts.	
Ejection.	
Cocking-handle.	
Condition of breech on:	
(a) "Cease fire."	} As for M.G. 34.
(b) End of belt.	
Sights: Types.	As for M.G. 34.
Range of adjustment.	Open sights, 200-2,000 metres Optical sight. As for M.G.34.
Type of fire.	Automatic only.
Speed of gun.	About 1,150-1,200 rounds per minute.



FIG. 11A.

(b) Loading and Unloading.

(i) Belt filling.

The belt used is the same as that used with the M.G.34. Each round must be pushed into the belt until the nib at the rear of each clip engages with the extractor groove at the base of the cartridge. Belts of 50 rounds may be joined together by interlocking first and last links and inserting a cartridge.

(ii) To load.

Pull back cocking-handle, push forward breech-cover catch, lift cover and insert belt from left side with belt on top of cartridges so that the first cartridge is against the stop on the right of the feedway, close cover. The gun is now ready to fire.

Note. On closing the cover see that the lug on the top of the breech-block engages in the groove of the feed-actuating-arm.

(iii) To unload.

Push forward the cover-catch, raise the cover and remove the belt. Close the cover, press the trigger and close the ejection-opening cover.

Note. The ejection-opening cover is hinged on the right side of the ejection opening and flies open on the first movement of the breech-block in either direction.

(c) Stripping and assembling.

(i) To strip.

1. Press catch on under side of butt, twist butt through one-eighth of a circle and remove from buffer spring housing.

2. Press rear end of catch on under side of body, twist buffer spring housing through a quarter turn clockwise and remove together with return spring.

3. Push forward body-cover catch and raise body cover and feed-block to vertical position. In this position only is it possible to withdraw the body-cover hinge-pin to the left. Having done this, remove the body cover and the feed-block.

4. Pull back the cocking-handle smartly and the breech-block will slide out of the rear of the body.

5. Push forward the barrel locking-catch, which is on the right of the gun just forward of the body, and swing the barrel carrier out to the right. Remove the barrel.

(ii) To assemble.

Reverse the procedure outlined above.

7. 6.5 mm. MODEL 30 { BREDA
7.35 mm. MODEL 38 { L.M.G.
(ITALIAN).

Note. The only difference between these two models is the calibre.

(a) Particulars.

Weight.	25½ lbs.
Length.	48½ ins.
Method of operation.	{ Recoil and projection of spent case.
Locking system.	{ Rotating locking-nut (Fermeture nut).
Feed.	{ Magazine fed by 20-round chargers.
Feed opening.	Right side.
Ejection opening.	Lower left side.
Cocking-handle.	Right side.
Type of fire.	Automatic only.
Rate of fire.	{ 450-500 rounds per minute (cyclic).
Breach open or closed on cessation of fire.	{ Closed.
Sights.	Open (Barleycorn and V).
Range of adjustment.	{ 300-1500 metres, clicking adjustment. Fixed battle sight 300 metres.

(See Fig. 12, p. 112.)

(b) Loading, firing and unloading.

(i) To load.

1. Release magazine catch and allow magazine to swing forward.

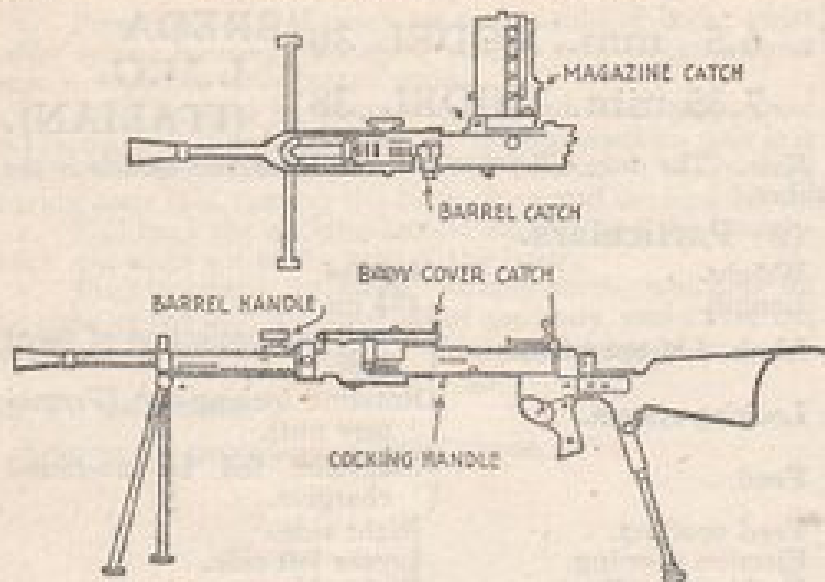

BREDA L.M.G. 6.5 MM. MODEL '30.

FIG. 12.

2. Insert charger in magazine, push home until last round is caught by cartridge catch and withdraw charger.
3. Swing magazine into position at right angles to gun.
4. Pull cocking-handle smartly to rear and let go.
5. Apply safety-catch at rear of body by turning downwards.

(II) To fire.

1. Pull back ejection opening cover on left of gun.
2. Raise safety-catch to vertical position.

3. Press trigger.

Note. On a temporary cessation of fire always pull back cocking-handle and retain in rear position by pressing in cocking-handle catch just behind the cocking-handle. To make ready to fire again it is only necessary to give the cocking-handle a short jerk to the rear when the catch will jump out of engagement allowing the breech-block to go fully forward.

(iii) To unload.

1. Press magazine catch and allow magazine to swing forward.
2. Cant gun over to right to remove loose rounds in magazine mouthpiece.
3. Pull back cocking-handle and let go, twice.
4. Press trigger to ease springs.
5. Push forward ejection opening cover.
6. When necessary, remove magazine from magazine hinge and swing hinge into magazine mouthpiece and secure.

(c) Stripping and assembling.**(i) To strip.**

1. Pull out barrel catch plunger on left of gun and lower barrel catch.
2. Turn barrel about 90° to left, slide barrel forward to clear body and withdraw to rear.
3. Push forward fingerpieces of butt catch (under back-sight), twist butt anti-clockwise and remove to rear, together with return spring, return spring guide and buffer spring.
4. Pull back cocking-handle and remove firing-pin, firing-pin spring and breech-block.
5. Remove cocking-handle by pulling fully to rear and lifting off to right.
6. Turn body cover catch (at rear of body cover) to right,

lift body cover, pull out body cover hinge-pin and remove cover.

7. Slide magazine off magazine hinge.
8. Lift out magazine mouthpiece retaining plate which is just in rear of magazine mouthpiece.
9. Slide magazine mouthpiece to rear and lift off to right.
10. Lift out ejector.
11. Turn gun upside down and with the point of a bullet press in the locking-nut catch cover retaining stud.
12. Slide catch cover off to the rear.
13. Push out the locking-nut catch hinge-pin and remove locking-nut catch and spring.
14. Turn gun right side up again and lift locking-nut H-piece retaining catch on left of body to horizontal position and withdraw to left.
15. Move locking-nut H-piece as far as possible to the rear and lift it out.
16. Lift out locking-nut.

Note. No other stripping is normally necessary or desirable.

(ii) To assemble.

Reverse the process in (i) above taking care to see that the locking-nut is twisted as far as possible anti-clockwise before attempting to replace the locking-nut catch.

(d) General information and points of interest.

- (i) The gun is operated partly by recoil and partly by projection of the spent case, the recoil being used to rotate the locking-nut and free the breech-block from its engagement with the rear of the barrel, thus allowing the remaining force of the explosion to drive the spent case and breech-block to the rear.

- (ii) Since the major part of the energy required to operate the weapon is derived from the projection of the spent case it is essential that both this and the breech-block should be lubricated. This is brought about by a small oil pump in the body cover where a plunger is forced upwards by a rib on the breech-block at every forward movement of the latter and forces oil through a small feed-way on to the round next to be fired as it waits in the magazine mouthpiece. The raising of the plunger also allows some oil to find its way on to the breech-block.
- (iii) One important disadvantage of this gun is that on cessation of fire the breech-block is forward and there is a live round in the breech. If the gun is hot this round may explode spontaneously (this is technically known as a "cook-off") and a special retaining catch is therefore provided behind the cocking-handle which can be used to hold the moving parts in the fully backward position in order to obviate this possibility. (See note to para (b) (ii).)
- (iv) In order to ensure that the striker spring is compressed sufficiently to give a blow strong enough to fire the round, and also to ensure that the round is not fired before the breech-block is fully forward and locked a forward sear is provided on top of the gun just inside the body cover. Assuming the trigger to have been held pressed this sear holds back the striker, thus compressing the striker spring, until it (the sear) is raised by ramps at the rear of the breech-block which do not engage with it until the locking-nut is actually turning and locking the breech-block to the barrel.

8. 8 mm. MADSEN L.M.G. (DANISH).

(a) Particulars.

Weight.	21 lbs.
Length.	45½ ins.
Method of operation.	Recoil.
Locked or unlocked.	Locked.
Feed.	Box magazine (overhead) 30 rounds.
Ejection.	Underneath.
Breech open or closed on:	
(a) Cease fire.	Open.
(b) Empty magazine.	Closed.
Type of sights	Open.
Range of adjustment.	200 to about 2,000 yards.
Barrel changeable.	Yes.
Calibre	8 mm.

(See Fig. 13, p. 117)

(b) Loading and unloading.

(I) To fill magazine.

Similar to Bren.

(II) To load.

1. Pull back cocking-handle and release it.
2. Place magazine on gun in magazine housing on the left of the body. Do this in the same manner as for the Bren.
3. Set change lever at "F".

Note. The position of the change lever can only be altered when the gun is cocked—see under Mechanism, p. 117.

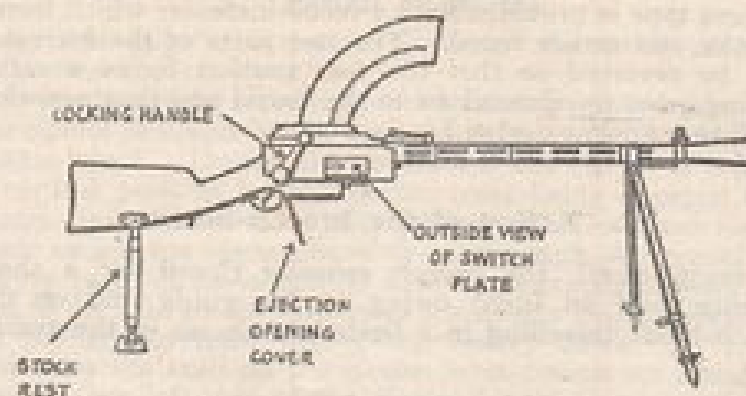

MADSDEN LIGHT MACHINE GUN

FIG. 13.

(III) To unload.

1. Put change lever at "Unl."—the unloading position.
2. Remove magazine.
3. Press trigger.
4. Pull back cocking-handle.
5. Set change lever at "F."
6. Press trigger.

For explanation see under mechanism.

(c) Mechanism.

(I) Backward action.

1. Action of recoil.

On the round being fired, the pressure of the gases forces the recoiling parts back, causing the recoil and firing levers to be forced upwards, compressing their springs. (The

Gamma type is provided with a recoil increaser which forms a choke and assists recoil. The two parts of the increaser may be reversed so that the rear portion forms a collar causing gases to rebound on to the barrel and thus assisting recoil to a greater degree.)

2. Action of the breech-block.

During recoil, the breech remains closed for a short distance (half an inch) owing to the guide stud on the breech-block travelling in a horizontal recess in the switch

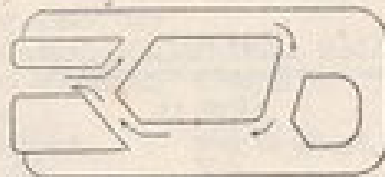

Sketch of "Switch Plate."

FIG. 14.

plate. During this movement the firing lever, being forced up by the rear of the breech mechanism, is freed from the hammer, enabling the latter to be pivoted back, and the firing-pin to be withdrawn, both under the influence of the firing-pin spring. The guide stud moves up the upper cam of the switch plate causing the front of the breech-block to be pivoted upwards to allow for ejection. The guide stud then travels along the top of the cam, and, when unsupported the spring on the cover causes the front of the breech-block to be pivoted downwards, and the guide stud to drop on to the rear stud of the switch plate.

3. Action of ejector.

In this gun, the ejector performs the work of both extraction and ejection.

Immediately the recoiling portions start to move backwards the ejector is raised by the inclined slope on the front of the ejector block. During this movement the ejector is kept in a vertical position by the ejector lever being engaged in a recess on the bottom of the ejector. This upward movement causes the ejector hook to engage with the rim of the empty case. The ejector is kept in engagement with the rim of the case by the bottom of the ejector being positioned on top of the front flat of the ejector block. As recoil continues the stud on the ejector lever travels up a sloping cam on the left side of the ejector block, compressing the ejector lever spring. This movement disengages the ejector lever from the ejector and this allows the tail of the ejector to be tripped forward by the step on the ejector block. Since the ejector is pivoted about its centre the tripping forward of the tail causes the head and hook to be thrown to the rear thus extracting and ejecting the empty case from the chamber.

The case is guided through the opening on the underside of the body by the ejection guide on the breech-block. The stud of the ejector lever is resting on the straight above the sloping cam, holding the ejector lever upwards free of the ejector. The ejector is therefore lying horizontally on top of the rear flat of the ejector block and underneath the breech block.

4. Action of the distributor.

Before recoil commences the distributor is kept open by the arm bearing on the top of the distributor cam in the breech mechanism. In this position, the distributor spring is tensioned and a live round is positioned in the seating of the distributor.

As the recoiling portions move back, the arm of the distributor is able to ride down the distributor cam, thus enabling the distributor to rotate inwards and downwards under the influence of its spring. This positions a round in the feed way against the left flange of the breech-block.

5. Action of the feed-arm.

As the recoiling parts travel back the rear surface of the front leg makes contact with the front face of the feed-arm actuating block. The feed-arm is thus rotated backwards. The bottom of the front leg now rides along the top of the feed-arm actuating block, thus preventing rebound of the feed-arm.

Note. When the ejection opening dust cover is closed, on cocking the gun, the legs of the feed arm automatically open the dust cover. First the bottom of the front leg strikes the centre projection of the dust cover, thus unlocking and partially opening it. In the rearward movement when the front leg rides on top of the actuating block, the back of the rear leg comes in contact with the rear projection of the dust cover, forcing it completely open.

(ii) Forward action.

1. Action of recoil lever spring.

On completion of the backward action, the recoil lever spring takes control and actuating the recoil lever, forces the recoiling parts forward.

2. Action of breech-block.

As the recoiling parts move forward the guide stud moves off the rear stud in the switch plate, and striking the rear surface of the centre block (in the switch plate), the breech-block is forced downwards, thereby exposing the chamber for the entry of the cartridge. The guide stud travels forward until it comes into contact with the lower cam surface of the switch plate, which causes the breech-block

to rise and close the breech. The guide stud is now in alignment with the horizontal slot in the switch plate. It travels forward along this slot during the final half inch of forward travel, thus ensuring that the breech is locked.

3. Action of ejector.

At the commencement of the forward action, the ejector is lying horizontally along the rear flat of the ejector block. The ejector lever is out of contact with the ejector as the stud of the ejector lever is resting on the straight above the sloping cam of the ejector block. As the recoiling parts move forward the stud on the ejector lever rides down this sloping cam, the ejector lever being forced downwards by its spring. The ejector lever thus comes in contact with the tail of the ejector.

During the continued forward movement, the ejector is raised by the ejector lever as soon as the breech block starts to rise, and the tail of the ejector is clear of the steps on the ejector block.

Note. The raising of the ejector is brought about by means of the ejector lever spring forcing the ejector lever further downwards. Should the ejector lever spring not operate for any reason the ejector lever will be forced down by the front cam on the left of the body acting on the ejector lever stud. The ejector lever being engaged with the tail of the ejector, its downward movement raises the head.

When the breech is closed, the ejector, being in front of the front flat of the ejector block, is able to rise to the vertical under the influence of the ejector lever spring, positioning itself in its seating just below the chamber, its hook being below, and clear of the rim of the cartridge.

4. Action of distributor.

During the forward movement the arm of the distributor is forced upwards by the distributor cam on the left side

of the frame. This forces the distributor outwards, tensioning the distributor spring. The next round in the magazine, which was resting on the distributor drops on to its seating in the magazine opening.

5. Action of feed-arm.

As the recoiling parts travel forward the front surface of the rear leg of the feed-arm makes contact with rear surface of the feed-arm actuating block, rotating the feed-arm forward. The arm engages the base of the cartridge which is in position against the left flange of the breech-block and forces it into the chamber. During the continued forward action the rear leg rides up the rear surface of the feed-arm actuating block and along the upper surface. The bottom of the rear leg being now on top of the feed-arm actuating block prevents the rebound of the feed-arm and holds cartridge in the chamber to allow the breech-block to rise.

6. Action of the trigger mechanism.

When the trigger is pressed the trigger spring is compressed and the trigger nose is disengaged from the bent of the recoil lever. The recoil spring forces the recoil lever downwards and being engaged in the link in rear of the breech mechanism, forces the recoiling parts forward. When the recoiling parts are almost home the recoil arm is not fully down. At this point the hump on the recoil lever bears on the flat of the sear forcing the sear downwards. This releases the nose of the sear from the bent of the firing lever, compressing the sear spring. The firing lever is forced downwards by its compressed spring and strikes the tail of the hammer. The front of the hammer forces the firing-pin forward and fires the cartridge. This action compresses the firing-pin spring which partially recovers immediately the cartridge is fired and withdraws firing-pin slightly clear of face of breech-block.

(iii) The mechanism of the change lever.

The change lever can be placed in one of three positions:

"F."—To fire.

"Unl."—To unload. { British type—other letters may
"S."—Safety. { obviously be found.

The change lever can only be positioned when the action is cocked owing to the rib on the bar of the change lever coming in contact with the sear, which is in its lowest position when the recoiling parts are forward.

"F."—To FIRE. The bar of change lever is rotated forward clear of the sear and upper arm of trigger, thereby allowing both to operate when trigger is pressed.

"UNL."—UNLOAD. The bar of change lever is brought to an upright position, engaging under the sear, leaving the upper arm of trigger free to function the recoil lever. The recoil lever forces the recoiling parts forward until the hump on the recoil lever comes in contact with the flat of the sear. As the sear cannot be depressed the firing lever cannot strike the hammer, neither can the recoil lever go fully down. The recoiling parts are thus unable to travel fully forward. The breech, however, is closed and live rounds can be ejected without firing.

"S."—SAFETY. The bar of the change lever is rotated and inclined slightly to the rear, and is brought into contact with under side of the sear and the upper arm of the trigger preventing both from being depressed.

(d) Stripping and assembling (component parts).

A. Locking-bolt.

(1) To strip.

1. See that the recoiling portions are forward, then raise the locking-bolt lever to the vertical position and pull out to the left.

3. Turn the gun slightly to the left, and disengage the butt by pushing it towards the right front, supporting the body on the left hand.

(ii) To assemble.

Raise the butt, push in locking-bolt, lower cover and turn locking-bolt lever down.

B. Barrel and breech mechanism.

(i) To strip.

1. Place the forefinger of the right hand in front of feed-arm axis bar, and draw back barrel and breech mechanism with the whole hand.

2. Complete withdrawal of barrel, etc. taking care that the front end of barrel does not come into contact with the short arm of the cartridge distributor, otherwise damage will be caused to the ring on the front end of the barrel. When the barrel has been removed lower the gun gently to the ground.

(ii) To assemble.

Support gun on the left hand as above, gripping the breech mechanism in right hand, place the barrel carefully into barrel casing avoiding contact with short arm of distributor, see that feed-arm is forward, place thumb in rear of feed-arm axis bar, and push barrel with breech mechanism fully home in one clean movement.

C. Breech block.

(i) To strip.

1. Remove breech-block bolt.

2. Place feed-arm to the rear, raise the front and depress the end of the breech-block fully, pivot front of breech-block up and back to a vertical position, ease the feed-arm forward and at the same time lift out the breech-block.

(ii) To assemble.

Reverse sequence as above.

D. Flash eliminator.

(i) To strip.

Depress securing catch and unscrew.

(ii) To assemble.

Reverse the above.

E. Ejector, ejector lever and spring.

(i) To strip.

1. Remove the ejector axis pin, and remove the ejector.

2. Remove the ejector lever axis pin, keeping the thumb on top of lever to prevent lever and spring from jumping out.

Remove ejector lever and spring by lifting them up.

(ii) To assemble.

Reverse the above.

F. Removal of firing-pin.

(i) To strip.

Sequence of instructions as above.

(i) Remove the firing-pin retaining screw.

(ii) Remove firing-pin and spring.

(ii) To assemble.

Reverse the order.

Note. All bolts on the gun are secured by wire. These must be first removed and lastly replaced.

(e) Stoppages and immediate action.

No.	Immediate action.	Symptoms.	Cause.	Remedy.
1.	Look for rounds through holes at bottom of magazine.	No rounds visible, hole of magazine platform seen.	Empty magazine.	Change magazine.
2.	As for 1.	Neither rounds nor platform visible.	Damaged magazine.	Change magazine.
3.	As for 1 and if rounds are visible look at and "feel" change lever.	Change lever at "Unloaded."	Change lever either set at, or tripped to "Unloaded."	(i) Open body cover. (ii) Cock gun. (iii) Set change lever to FIRE. (iv) Close body cover. (v) Continue firing.
4.	As for 3 and if change lever is correct lift body cover.	Recoiling parts loose and base of a round is visible in the chamber.	Misfire.	(i) Cock gun. (ii) Close body cover. (iii) Continue firing.
5.	As for 4.	Recoiling parts fully home but no round is visible in the chamber.	(i) Loss of recoil due to parts not coming back far enough for a round to be positioned against flange of breech-block, or (ii) If stoppage occurs may be due to damaged mouth of magazine.	(i) Cover down. (ii) Cock gun. (iii) Continue firing. If stoppage recurs due to enlarged mouth of magazine. (iv) Change magazine.
6.	As for 4.	Recoiling parts not fully home and a round protruding from chamber and lying on top of breech-block.	Belged round.	(i) Shoot for head extractor. (ii) With left hand pull back cocking-handle and hold back. (iii) With hand extractor in right hand strike round backwards and examine.

7.	As for 4.	As for 6.	Separated case.	<p>(iv) If round is damaged, cast round and return hand extractor.</p> <p>(v) Close body cover with right hand.</p> <p>(vi) Return cocking-handle with left hand.</p> <p>(vii) Return left hand to trigger control lever.</p> <p>(viii) Continue firing.</p> <p>As for 6 up to (iii).</p> <p>(ix) If good round is extracted, cast round and shoot for "clearing plug."</p> <p>(x) If spare barrel is available remove magazine and, with hand extractor, No. 2 remove loose rounds from distributor.</p> <p>(xi) Change barrel.</p> <p>(xii) Continue firing.</p>
8.	As for 4.	As for 4, but on applying remedy for misfire C.I.F. cannot be pulled back.	Thick rimmed cartridge.	<p>(i) No. 2 shoots "thick rim," gives hand extractor to No. 3.</p> <p>(ii) No. 3 places rounded end of tool in slot in right front end of breech-block and lever upwards, while No. 1 pulls C.I.F. sharply to rest.</p>

Note. If no spare barrel available, e.g. possibly in L.A. rifle, the barrel must be taken out of the gun and the breech-block removed from the frame. The separated case will be removed with the clearing plug in the usual way.

Continued on next page.

MADSEN

No.	Immediate action.	Symptoms.	Cause.	Remedy.
9. As for 4.	Chamber empty. Recoiling parts back and unable to go forward on pressing trigger.	After a stoppage pulling back cocking-handle with cover closed.	(iii) The round should be ejected, but if it sticks half-way. No. 5 must stick the round downwards with the left hand whilst still keeping C.H. to rear with right hand.	
10. As for 4.	Recoiling portions held forward. Feed arm upright. Round trying to enter chamber diagonally.	Cross feed due to loss of recoil.	Pull back cocking-handle fully to rear and hold back, with fingers of left hand, flick round down from underneath.	
11. As for 4.	Recoiling portions half-way forward. Feed arm nearly down. No round in feed-way but empty case half out of chamber.	Failure to extract or eject due to loss of recoil.	(i) Remove magazine. (ii) Clear rounds in dis-tributor with hand extractor. (iii) Cock gun. (iv) Pull round in feed-way back until in the correct position. (v) Pulling cocking-handle fully back with right hand, press breech-block open with left hand. (vi) Close cover. (vii) Magazine on. (viii) Commence firing.	

(ii) If this is impossible work recoiling parts back-wards and forwards a few times and the stoppage will clear itself by the case either dropping out or entering the chamber and being ejected.

Warning.—It is possible for a live round to become jammed in a hot chamber with the breech not correctly locked. In this event, the cartridge will probably "cook-off" and the case become a missile. Do not attempt I.A. in such a case but close the cover if open and stand clear for a couple of minutes.

Stoppages and immediate action.

When a stoppage occurs, the cocking-handle gives no indication of the cause of failure. The method of dealing with the stoppages and the immediate action to be applied by the gunner therefore differs from the type of immediate action in either Vickers or Lewis guns. When for any reason the gun stops firing, the preceding sequence of immediate action is suggested.

CHAPTER III

MEDIUM MACHINE-GUNS

Preliminary.

A medium machine-gun is an automatic weapon of rifle calibre which is capable of sustained rapid fire, and which is fired from a tripod or other form of mounting.

Most medium machine-guns are belt fed. This enables them to carry out their sustained fire tasks, which demand a comparatively high output in rounds per minute over a period of time. An air-cooled magazine-fed weapon is capable of doing the same thing for a short time, but this demands constant barrel and magazine changing, and magazine filling, with consequent undue fatigue to the gun's crew. The period over which a high rate of fire can be maintained is much shorter with a magazine-fed weapon and, if it is designed as a L.M.G., its capacity over a long period is on a lower scale.

The belt method of feed necessitates rather more complicated mechanism than the box magazine type, which is the normal for Light Machine-guns. Stoppages, and immediate action to rectify them, are, therefore, more complicated also. Thus a certain amount of knowledge regarding the mechanism is desirable if immediate action is to be applied intelligently. Especially is this the case with the oldest type action of all, i.e., the Maxim type, which in these days in the British service is exemplified by the Vickers Medium Machine-gun. Rather more mechanism details are, therefore, required to enable certain guns in this category to be described adequately.

MEDIUM MACHINE-GUNS

1. .303-INCH VICKERS M.G.

(a) Particulars.

Service designation of:	
Gun.	.303-inch Vickers M.G. Mk. I.
Tripod	Mounting tripod. Mk. IV.B.
Weight of gun:	
Without water.	30 lbs. (approx.).
With water.	40 lbs. (approx.).
Length of gun	3 ft. 7½ ins.
System of operation.	Recoil.
Locked or unlocked.	Locked.
Method of locking.	Toggle joint.
Method of feed.	Fabric belt of 250 rounds.
Feed opening.	Right side of feed block and gun.
Ejection.	Underneath.
Speed of gun.	500 rounds per minute.
Service rates of fire.	{ Rapid—1 belt per minute Medium—½ belt per minute. Slow—¼ belt per minute.
Ammunition.	.303-inch Mk. VIII. Z.
Sights.	0 to 4,000 yards.
Type of sight.	Aperture.
Battle sight.	Yes. 400 yards.
Weight of tripod.	50 lbs.

(b) Loading, Firing and Unloading.

(1) To load.

1. Pass tag end of belt through feed block from right and hold this on the other side with left hand.
2. Pull crank handle up and back on to roller.
3. While holding crank handle back, pull belt through feed block to the left as far as it will go.

4. Release crank handle, which will fly forward again under the influence of the fusee spring.

Note 1. The above motions enable the base of the first cartridge in the belt to be gripped by the top of the extractor, preparatory to its being withdrawn from the belt on the next backward movement of the extractor.

5. Repeat motions 2, 3, and 4.

Note 2. The repetition of the initial loading motions performs the following operations:

- (i) The extractor withdraws the first round from the belt as the lock comes to the rear.
- (ii) The extractor drops when it gets to the end of the cams in the body (if it does not drop, it is forced down by the ramps on the underside of the rear cover).
- (iii) The first round is thus presented to the barrel on its correct level and the forward movement of the lock thrusts it into the chamber.
- (iv) Just before the lock gets home the side levers, acting on the extractor levers, raise the extractor once more. Since the first round is almost home in the chamber and cannot rise with it, the base of this cartridge rides down the gib on the face of the extractor.
- (v) When the extractor has risen to its fullest extent, the firing-pin hole in the bottom of the extractor is opposite the cap of the round in the chamber and the top of the extractor grips the next round in the belt. There are then two live rounds on the face of the extractor, one in the chamber and one in the feed block.

The gun is now fully loaded.

(ii) To fire.

1. Place both hands on the grips with the forefingers on top of the top grip supports, the second fingers on the far side of the safety-catch, and the thumbs on the firing-lever thumb-piece. Do not grasp the grips as if your life depended on it. The gun does not require holding to ensure accuracy

—the tripod does the job for you. Incidentally, the effort of trying to grip tightly and control the gun will tire you out if you have to do any sustained firing.

2. Lift the safety-catch towards you with your second fingers and,

3. Press in the thumb-piece with your thumbs.

Note 1. The rising of the safety-catch clears the way for the forward movement of the firing-lever. The safety-catch is kept in its normal, or down, position by means of a spring which also serves to keep the firing-lever to the rear. In the "down" position the safety-catch bars the way against any forward movement of the firing-lever sufficient to fire the round in the chamber.

Note 2. When the firing-lever goes forward, the pawl at the bottom pushes forward the bottom of the trigger bar lever. This, being pivoted in the centre, has its top portion withdrawn to the rear. The top of the trigger bar lever is engaged in front of a projection at the rear of the trigger bar. The trigger bar is thus pulled to the rear. At the front of the trigger bar is a slot in which lies the tail of the trigger. The backward movement of the trigger bar, therefore, draws back the tail of the trigger. The trigger is pivoted in the centre and thus its nose goes forward and is released from the bent of the tumbler. The semi-upright position of the tumbler prior to this has kept the firing-pin to the rear with the lock spring compressed. The tumbler now being free to rotate, the firing-pin is allowed to fly forward, under the influence of the lock spring, and fire the cap of the round in the chamber.

The above is a brief résumé of the action taking place up to the moment of firing of the first shot.

(iii) To unload.

1. Pull the crank handle back on to the roller and release it.
2. Repeat.
3. Disengage the top and bottom feed pawls by squeezing the pawl grips.

4. Keeping the pawls disengaged, as in 3 above, withdraw the belt.

5. Lift safety-catch and press thumb-piece.

Note. The pulling to the rear of the crank handle without any motion to feed the belt over for a round to be in position to be gripped by the extractor achieves the following results:

- (i) The round in the chamber has been extracted and when the extractor drops, it either drops off of its own accord, or, when the extractor rises, it is forced off by the seating for ejection just underneath the bottom of the rear of the barrel.
- (ii) The round in the feed block is withdrawn as usual, and put in the chamber, but no fresh round is gripped by the top of the extractor.
- (iii) The round now in the chamber is disposed of as in (i) by the second rearward movement of the crank handle. The face of the extractor is thereby cleared of cartridges.
- (iv) The belt has been held in position up till now by the bottom pawls lying behind the second round in the feed block and the top pawls behind the first round. The latter pawls feed the round into position as recoil takes place, while the former prevent any backward movement of the belt when the top pawls recover to their first position in readiness for feeding the next round.

The pawls must therefore, be cleared out of the way before the belt can be withdrawn to the right.

(c) Brief description of mechanism not so far covered.

(i) Recoil.

1. When a round is fired, the barrel, to which are attached the inside plates, recoils approximately one inch. Recoil is assisted by trapping the gases in the muzzle attachment so that some of their energy is expended in helping to push the recoiling portions to the rear. This is achieved by means of the cone in the muzzle attachment, and the muzzle cup.

2. At the rear end of the left side plate is fixed the fusee, to which is attached the fusee spring. The front end of the latter is fixed to front end of its box, which in turn is fixed to the outside of the body. Thus the front end of the spring is anchored, while the rear end, being connected to the fusee, travels to the rear. The spring is thereby extended.

3. At the front end of the prolongation of the left side plate, there is a recess into which fits the bottom lever of the feed block. On recoil taking place, the bottom lever is brought to the rear. The top and bottom levers being pivoted to one another at right angles the top lever moves to the right. To the top lever is connected the slide and top pawls. These, therefore, also move to the right. This movement is the preparatory one for the feeding over of the next round.

(ii) Method of locking the action and its unlocking on recoil.

The action is locked by the fact that the axis of the crank pin (which joins the connecting rod and crank) in the locked position is below the level of a line joining the crank axis, and the axis of the side levers of the lock. The crank is rigidly supported underneath by the inside plates. Pressure on the face of the lock, taken through the axis of the side levers merely tends, therefore, to press the crank harder down on the inside plates. The toggle joint thus formed cannot be broken until

- (i) About $\frac{1}{4}$ inch recoil has taken place, and
- (ii) The tail of the crank handle has been forced back in contact with the roller and the crank handle been made to rotate.

Owing to the shape of the tail of the crank handle, the crank is forced to rotate upwards, thus raising the crank pin axis above the other two axes.

The continued rolling of the crank handle on the roller

I LOCK COCKED ON TRIGGER- READY FOR FIRST SHOT

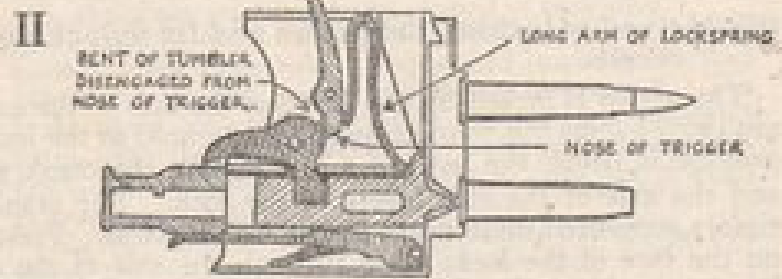
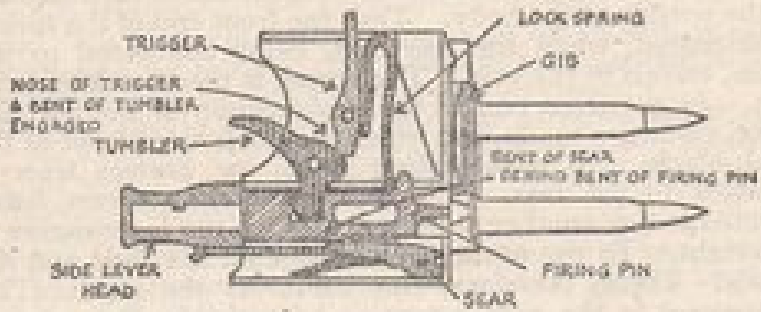

LOCK FIRED

FIG. 15.

and consequent lifting of the crank through about 130 degrees to 140 degrees,

- (i) Cocks the lock by means of the side lever head and tail of the tumbler, and
- (ii) Fully withdraws the lock so that the extractor is able to drop or be forced down behind the cams on the body.

III LOCK JUST COCKED ON SEAR

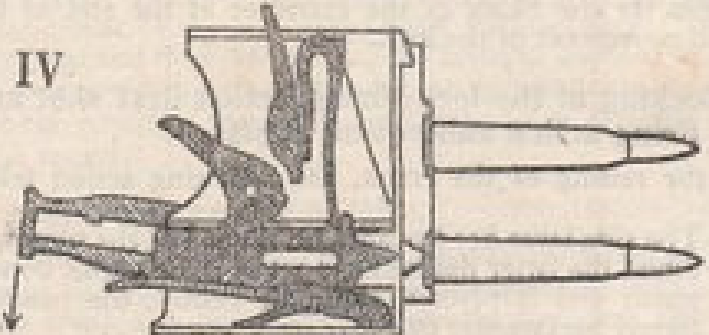
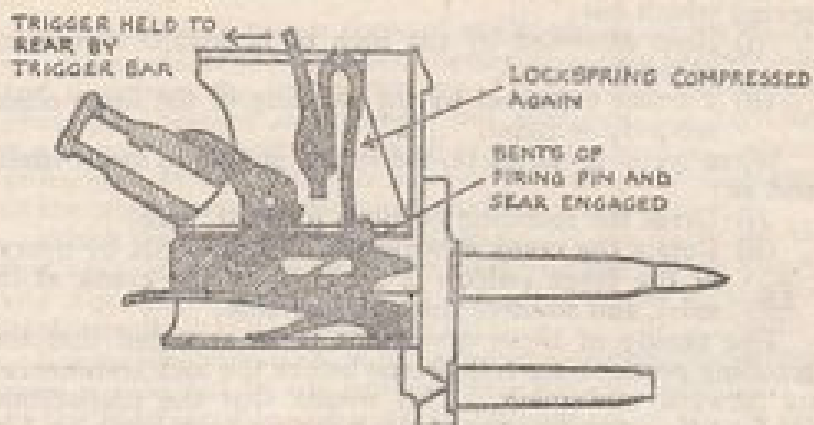

SIDE LEVER HEAD MOVING DOWN JUST ABOUT TO FIRE SECOND SHOT BY PUSHING SEAR OUT OF ENGAGEMENT WITH FIRING PIN

ABOUT TO FIRE SECOND SHOT

OFF SEAR www.vickersmachinegun.org.uk

(iii) Forward movement.

Forward movement is effected by means of the fusee spring which has

- (i) Been extended by the inch of backward movement of the fusee and,
- (ii) Further extended by the winding of the fusee chain around the fusee.

When recoil is complete, the spring is able to assert itself, and so:

- (i) Drive the recoiling portions forward, and
- (ii) Rotate the crank downwards and forwards by means of the fusee (which is attached to the crank at its axis), and so force the lock forwards.

The timing of these operations is so arranged that the recoiling portions are fully home before the lock commences its forward movement. This means that the preparation for feed (i.e. moving over of the belt) has been completed in readiness for the rising of the extractor at the end of the forward movement of the lock.

(iv) Cocking of the lock, firing action first shot and firing action subsequent shots.

On the raising of the crank, the following action takes place:

- (i) The side lever head pushes up the tail of the tumbler.
- (ii) Since the latter has its head set at right angles downwards and is pivoted about its centre, the head is forced backwards; this
- (iii) Withdraws the firing-pin, since the head of the tumbler is positioned in a recess at the rear of the firing-pin.
- (iv) Backward movement of the firing-pin continues until
 - (a) The nose of the trigger passes over the bent of the tumbler and positions itself above it, and
 - (b) The bent of the firing-pin and the bent of the sear engage.

Note. The sear, and consequently the bent of the sear, is forced upwards under the influence of the sear spring.

When the lock travels forward at the end of its movement the underside of the side lever head comes into contact with and depresses the tail of the sear. The bents of sear and firing-pin become disengaged, but owing to the fact that the nose of the trigger is situated as in (iv) (a) above, forward movement of the firing-pin is restricted by the engagement of the trigger nose and bent of tumbler.

When the firing lever is pushed in for the firing of the first shot, the trigger bar pulls back the top of the trigger and disengages the nose from the bent of the tumbler as explained in (b) (ii) *Note* 2 (p. 133).

For subsequent shots, you must remember that the trigger nose is held out of any possible engagement with the bent of the tumbler (See Fig. 15). The lock cocks on the sear as already described, and firing is performed by the downward movement of the side lever head pushing down the tail of the sear and thus disengaging the bents of sear and firing-pin. There now being no trigger nose to oppose complete rotation of the tumbler, the firing-pin is free to go forward and fire the round.

(d) Mechanical safety.

It will be seen that the final movement down of the side lever head fires the round. This final movement also places the crank axis below the line joining the other two axes of the toggle joint. The round cannot, therefore, be fired unless the toggle joint has been formed.

(e) Stripping and assembly.**(i) To strip.**

1. Push up rear cover catch at back of gun and raise

rear cover until it comes to a stop at about 20 degrees to 30 degrees past the vertical.

2. Pull back crank handle on to the roller and lift out lock and connecting rod. Turn lock one-third to right and disconnect from the connecting rod. Close rear cover.

3. Go to front of gun and take out muzzle attachment split pin, turn attachment to left and pull off to the front.

4. With combination tool unscrew muzzle cup from front end of barrel.

5. Unlatch front cover by turning cover latch upwards anti-clockwise, lift up front cover. Lift up feed block complete and remove. Close front cover.

6. Push forward the fusee spring-box to clear the hooks at the front and rear ends from their studs and disconnect box from gun and spring from fusee chain.

7. Remove fusee and chain to the left.

8. Lift rear cover again.

9. Unscrew "T" fixing-pin of rear cross-piece and remove. (This is the large "T" headed pin on the left rear of the body.)

10. Drop rear cross-piece to the horizontal position.

11. Withdraw to the rear the left and right slides. The latter carries the roller.

12. Withdraw to the rear the crank, right and left inside plates and barrel by pulling the crank handle stem straight to the rear.

13. Disconnect left and right plates from crank and barrel.

(ii) To assemble.

Reverse the above order.

Note. When assembling the feed block to the gun, see that the slide is in to the left. In this position the stud on the bottom lever is forward and able to enter its recess in the prolongation of the left inside plate.

(f) Component stripping and assembly.

(i) To strip the lock.

1. Cock the lock by raising the side lever head.
2. Force out side lever split-pin and bush axis side levers.
3. Remove side levers, extractor levers and extractor.
4. Push out the tumbler axis pin and remove tumbler.
5. Release the lock spring by pushing down the tail of the sear.
6. Push out trigger axis pin and remove trigger.
7. Remove lock spring, firing-pin and sear with spring.

(ii) To assemble the lock.

1. Replace:
 - (i) Sear.
 - (ii) Firing-pin.
 - (iii) Trigger and trigger axis pin.
 - (iv) Tumbler and tumbler axis pin.
 - (v) Extractor.
 - (vi) Extractor levers on tumbler axis pin.
 - (vii) Side levers, side lever axis bush and split pin.
2. See that "all tails are down," i.e., that the lock is in the "fired" condition. To do this, proceed as follows:
 - (i) Depress sear *tail* by means of side lever head.
 - (ii) Push *tail* of tumbler down on to side lever head.
 - (iii) Pull back *tail* of trigger.
3. Insert lock spring—long arm to the front—in the space in front of the trigger.
4. Test assembly by cocking the lock and firing it. Cock by an upward movement of the side lever head. Fire by pulling the tail of the trigger to the rear and then depressing the side lever head.

Note. When firing the lock, make sure that you keep your fingers clear of the tail of the tumbler, or you will get severely pinched.

(iii) To strip the feed block.

1. Force out split-pin.
2. Separate top and bottom levers.
3. Take out slide and remove top pawls and spring.
4. Pull out bottom pawl axis pin, and remove spring and pawls.

(iv) To assemble the feed block.

Reverse the order of stripping.

(g) Points before firing.

(i) Rear and front barrel packings.

(a) REAR BARREL PACKING. Wind a strand or two of asbestos string in the cannellure of the barrel. Press the asbestos together with a piece of wood, or the point of a screw-driver or similar object, until the cannellure is full; then oil the asbestos and smooth it down flush with the barrel.

(b) FRONT BARREL PACKING. Unscrew the packing-gland, and wind round the barrel some oiled asbestos string. Whilst winding push the string in firmly with some semi-blunt object, and compress it as much as possible. Screw on the gland as tightly as can be done by hand.

(ii) To weigh the recoiling portions.

1. Remove the fusee spring.
2. Place the crank-handle nearly vertical.
3. Place the loop of spring-balance over the stem of the crank-handle, and pull slowly to the rear.
4. Weight to move should not exceed 4 lbs.

(iii) To weigh the fusee spring.

1. Remove lock.
2. Place loop of spring-balance over the knob of the crank-handle.
3. Standing on left of gun, press down check-lever with left hand.
4. With right hand pull balance vertically upwards; the reading indicated when the crank-handle starts to move should be between 7 and 9 lbs.

Note. To reduce weight turn vice-pin upwards and vice-versa. You can take it that three clicks subtract or add about half a pound.

(iv) Testing the length of the connecting-rod and adjusting cartridge head-space.

1. Remove fusee-spring and lock.
2. Strip the lock and replace only the side levers with bush and extractor.
3. See that the adjusting nut is tight.
4. Place a thin washer on the front of the adjusting nut and replace partially assembled lock.
5. From underneath the breech insert in the extractor over the firing pin-hole a dummy round, or a .064 armourer's gauge, and lift extractor.
6. With recoiling portions fully home, guide the dummy round or gauge into the chamber.
7. Rotate crank-handle slowly downwards under control, and see if there is a slight check just before reaching the check-lever.
8. If there is no check, add separate washers until a check is felt.
9. A check having been obtained with the washers used, determine the next lowest combination of washers from those used to obtain the check.

10. Place remaining washers underneath the adjusting nut on the shoulder of the connecting-rod, and screw up adjusting nut.

Note. On service use a live round, but see that the gun is pointed away from your own troops.

(h) Stoppages and immediate action.

(1) Stoppages.

In the Vickers medium machine-gun the position of the crank-handle denotes the type of stoppage which has caused failure. The handle may stop in one of four positions as follows:

Type of Stoppage	Position of crank-handle.	Cause.
First position.	Slightly to rear of vertical.	The lock is unable to come back far enough to allow the extractor to drop.
Second position.	Slightly in advance of vertical.	The lock is unable to go fully home after recoil.
Third position.	Not quite down on check lever.	The extractor is unable to rise to its highest position. If the feed block slide is jammed there is a fault in feed.
Fourth position.	Down and home on check lever.	There has been no explosion, or, if any, there has been little or no recoil, the lock remaining in its forward position.

The method of competing with these stoppages is described as follows:

(ii) Immediate Action.

Type of Stoppage	Immediate action.	Probable cause.
First position	<ol style="list-style-type: none"> 1. Pull the crank handle on to the roller, pull the belt to the left front, and let go the crank handle. 2. If, after carrying out 1, the crank handle stops in the same position when going forward, pull crank handle on to roller, open the rear cover, clear the face of the extractor, change the lock and reload. 3. If failure recurs, repeat 1, and lighten fuze spring by three "clicks." 	<ol style="list-style-type: none"> 1. If the extractor has not dropped, this may be due to: <ol style="list-style-type: none"> (i) Lack of recoil (due to a variety of causes). (ii) (a) Too heavy fuze spring. (b) Want of oil in working parts. (c) Grit in working parts. (d) Excessive packing. (e) Tight pockets in belts. (f) Friction due to frozen oil or water. 2. If the extractor has dropped, this may be due to a weak or broken gib spring.
Second position	<ol style="list-style-type: none"> 1. Force the crank handle to the rear and call out "clearing plug," open the rear cover, lift up lock and examine the cartridge on the face of the extractor. If a damaged cartridge, or an undamaged cartridge with the front portion of a separated case adhering to it is found, call out "don't want it," clear the face of the extractor and reload. 	<ol style="list-style-type: none"> 1. (a) Damaged cartridge. (b) Separated case with front portion withdrawn telescoped on undamaged cartridge.

<i>Type of Stoppage</i>	<i>Immediate action.</i>	<i>Probable cause.</i>
Second position.	2. If an undamaged cartridge with no front portion of separated case adhering to it is found on the extractor, replace the lock, keeping the crank-handle on the roller. Take the clearing plug, (seeing that the centre pin is back) and insert it into the chamber. Push the pin well home by allowing the lock to go forward slowly, keep a firm pressure on the crank handle, give the clearing plug a rocking motion; withdraw the lock; strike back the handle of the clearing plug and withdraw it (seeing that the front portion of the separated case is on the clearing plug) and reload.	2. Separated case. Front portion remaining in chamber.
Third position.	1. Slightly raise the crank handle, pull the belt to the left front, let go the crank handle and then strike it down on the check lever.	1. A cartridge is fed up slightly cross-wise.

Note. With Mark II plugs which have no handles, use by inserting the rim in the extractor, and position it in the recess in the gib before insertion into the chamber.

<i>Type of Stoppage</i>	<i>Immediate action.</i>	<i>Probable cause.</i>
Third position.	2. If the stoppage recurs, repeat the immediate action, unload, oil the working parts, and reload. 3. If 1 fails, examine feed block slide. If jammed No. 1 calls out "feed block," pulls the crank handle on to the roller,* raises the rear cover and hangs the lock. No. 1 then draws back the recoiling portions while No. 2 depresses the pawls and withdraws the belt. No. 1 then allows the recoiling portions to go forward thus allowing the feed block slide to go over to the left. No. 2 then straightens the rounds in the belt. No. 1 will then lower the rear cover, pull the crank handle on to the roller, pull the belt to the left front and let go the crank handle.	2. Friction in lock, etc. 3. (a) Bent or damaged long brass strip, if an equipment belt is being used. (b) Badly-filled belt. (c) Worn or loose belt pockets. (d) Belt box not in line with the feed block.
	* <i>Note.</i> In order to do this it may sometimes be necessary to open the front cover and force down the horns of the extractor.	<i>Note.</i> The effect of a fault in feed is that the top pawls being engaged behind a cartridge in the belt, are held fast, when some obstruction, such as above, prevents the belt from passing freely through the feed block. The recoiling portions being connected by the top and bottom levers to the slide, are arrested and prevented from going home. The distance they are held back depends upon the point at which obstruction asserts itself.

<i>Type of Stoppage</i>	<i>Immediate action.</i>	<i>Probable cause.</i>
Third position.	4. If slide is free, No. 1 calls out "extractor" and opens the front cover. No. 2 forces down the horns of the extractor. No. 1 clears the face of the extractor. No. 2 depresses the pawls, withdraws the belt and removes the first cartridge in the belt, and then No. 1 closes and locks the front cover and reloads.	4. Thick rimmed cartridge, or dirt behind the rim.
Fourth position.	1. Pull the crank handle on to the roller, pull the belt to the left front and let go the crank handle. 2. If 1 fails, pull crank handle on to roller twice, change lock and reload. 3. If when performing 1, No. 1 notices that more belt than usual comes through to the left, he performs the second half of the loading motions.	1. Defective ammunition. 2. (a) Broken or damaged firing-pin. (b) Broken lock spring. 3. Empty pockets in the belt.

Note. The firing of two rounds only, after I.A. denotes a failure in the feed block. I.A. puts two more rounds on the face of the lock, and failure again occurs, due to no feed having taken place. To remedy; change the feed block.

2. BROWNING .30 MEDIUM M.G.

(a) Particulars.

Weight (less water).	33 lbs. approx.
Length.	3 ft. 2 ins. (approx.)
Method of operation.	Recoil.
Locked or unlocked.	Locked by rising locking block.
Feed.	250-round fabric belt.
Direction of feed.	Left to right (reverse to Vickers).
Ejection.	Underneath.
Type of fire.	Auto only.
Rate of fire.	400-500 rounds per minute.
Sights.	Aperture or semi-open. (See special features.)
Range of adjustment.	See special features.
Weight of tripod.	45 lbs. (See Fig. 16, p. 150).

(b) Loading and unloading.

(i) To load.

1. Pull belt tag through feed block from left to right and give belt a sharp jerk.
2. Pull cocking-handle to the rear and release it.
3. Repeat 2 above.

(ii) To unload.

1. Raise cover.
2. Remove belt by pulling out to left.
3. Pull cocking-handle to rear and look or feel that there is no round on the face of the breech-block.
4. Lower the extractor.
5. Release the cocking-handle.
6. Lower cover.
7. Press trigger.

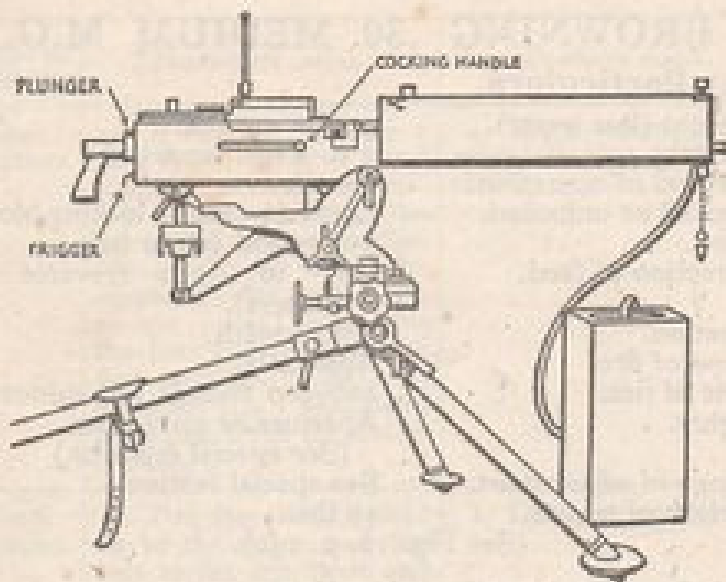

BROWNING MEDIUM MACHINE GUN

FIG. 16.

(c) Stripping and Assembly.**(i) To strip.**

1. Pull back cover and rear plate catch and raise cover.
2. With *left* hand pull back cocking-handle to fullest extent and with right hand (using the rim of a cartridge or a small screw-driver) push in the driving spring rod and turn one-quarter turn to the right, i.e. till slot in rod is vertical.
3. Push forward cocking-handle about one inch. This clears driving spring rod from rear plate.
4. Push forward cover and rear plate catch and push

rear plate up out of engagement with the body by means of the pistol grip.

5. Pull back cocking-handle to fullest extent and withdraw handle to the right.

6. Take hold of driving spring rod and pull breech-block out to the rear.

7. Insert nose of round in hole on right side of body, pushing in the trigger-pin against its spring. This acts as the lock frame retaining pin. Withdraw lock frame, barrel extension, and barrel to the rear.

8. Push forward accelerator claws and disengage lock frame from barrel extension.

(ii) To assemble.

1. Insert barrel and barrel extension into gun body until the projection on the under side of the extension rests against the bottom plate on the body.

2. Assemble lock frame to barrel extension as follows:

- (i) Put accelerator claws in front of "T" shaped projection of barrel extension from the underside.
- (ii) See that the prongs of the lock frame enter the slots made for them in the barrel extension.
- (iii) Snap lock frame forwards against the barrel extension. This will cock the accelerator on the plunger spring and lock the frame to the barrel extension.

3. Lift up rear end of lock frame and push forward barrel, barrel extension and lock frame until held up by the trigger-pin on the right side.

4. Push in trigger-pin against its spring and complete forward movement of lock frame, etc., until the trigger-pin engages once more in its hole in the right of the body.

5. Replace breech-block as follows:

- (i) See that cocking-lever is forward.
- (ii) Rest front end on top of lock frame and push forwards gently.

- (iii) Stop forward movement when cocking-handle hole appears opposite the rear of the cut away portion on the right of the body.
6. Insert cocking-handle and push breech-block forward about one inch.
 7. Push forward cover and rear plate catch and insert rear plate and pistol grip from the top. See that it is quite home and release catch.
 8. Pull cocking-handle back to rearmost position.
 9. Holding cocking-handle back with left hand, with right press in driving spring rod and turn one-quarter turn to the left, i.e. till slot in rod is horizontal.
 10. Release cocking-handle.
 11. See that the slide is as far as possible to the right and close the cover.

(d) To strip and assemble component parts.

A. To strip breech-block.

1. Remove extractor to the left.
2. Holding breech-block firmly, with rim of cartridge push in driving spring rod and turn one-quarter turn to the right maintaining a strong pressure. Release pressure slowly and the driving spring and rod will be forced out by the spring. Be careful not to point the breech-block at anyone, since the spring and rod are liable to come out with considerable force should the cartridge rim slip.
3. Take out cocking-lever pin and cocking-lever.
4. Turn breech block upside down and with nose of round push up sear. This releases firing pin spring.
5. Turn breech-block correct way up and pry sear spring into its recess by inserting the nose of a round into the slot of the sear spring and pushing over to the left. The sear will then drop out.
6. Push sear spring back into its normal position and with

the nose of a bullet push up sear spring pin and remove sear spring.

7. Tilt breech-block to the rear and remove firing-pin complete with spring.

To assemble breech-block.

1. Replace firing-pin complete with spring, with the flat towards the bottom of the breech-block.
2. Replace sear spring, pushing down free end and prying it into the recess on the left side of the breech-block.
3. Replace sear from the underside of the breech-block and push out sear spring from its recess and into engagement with the sear.
4. With breech-block top side uppermost insert cocking-lever in position as follows:
 - (i) Insert thick end with the rounded hump downwards, through gap in sear spring, into the recess in the firing-pin.
 - (ii) Push it firmly down until it clicks into position.
 - (iii) Insert cocking-lever pin from left side of breech-block.
5. Cock firing-pin spring by pulling cocking-lever forwards.
6. With breech-block front end downwards on a table or box insert driving spring and rod into the hole in the rear of the breech-block and proceed as follows:
 - (i) Take hold of as many coils as you can with your left hand, holding the breech-block on the table as firmly as possible.
 - (ii) Push the driving spring rod through as far as possible until it enters the hole in the breech-block.
 - (iii) Shift your hands until you are pressing down with the right thumb. Push the two keys into the slots and turn them clockwise into their recesses.
 - (iv) When engaged, complete one-quarter turn by means of rim of cartridge or screw-driver.

7. Replace extractor in rear hole in breech-block by inserting in the vertical position and turning it downwards into place.

B. To strip lock frame.

1. Take out trigger-pin to the right complete with spring. Withdraw trigger to the rear.
2. Push out accelerator pin to the right and remove accelerator.
3. Place lock frame on table or box and carefully ease out plunger and spring from left side. Be careful not to let the spring fly out.

To assemble lock frame.

Reverse the above order.

N.B. Assemble plunger and spring with lock frame firmly held down on a table or box.

C. To strip slide from feed block.

1. Turn out to the right the retaining pin on the right of the backsight block.
2. Remove pin.
3. Remove feed lever.
4. Remove slide.

To assemble.

Reverse the above order.

(e) Points before firing.

(1) Adjustment of cartridge head space.

The correct head space is obtained by means of screwing up the barrel into the barrel extension until the action will just close (i.e. recoiling portions will go forward) without being forced. Then *unscrew* two notches. This is best done with the aid of the combination tool.

(11) Packing the barrel.

Rear and front packings must be adjusted in the same manner as for the Vickers.

(f) Stoppages and immediate action.

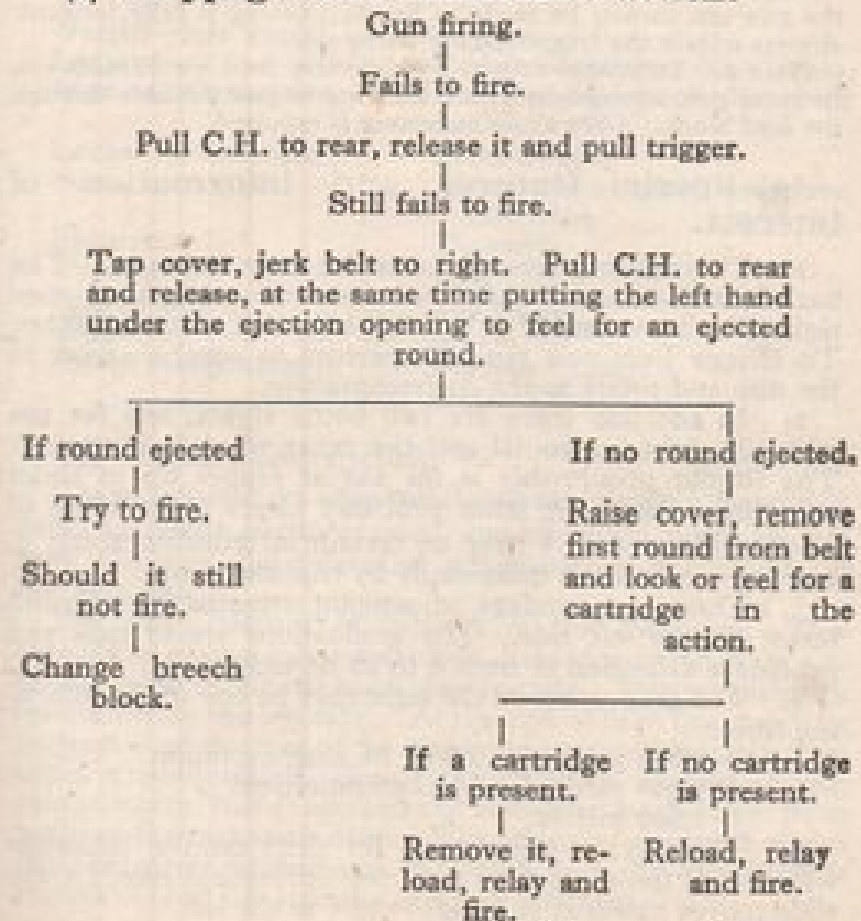

If the above does not produce any result look for breakages in, or damage to, the feed mechanism. Failing that it may be a separated case which must be cleared by means of the clearing plug.

Note 1. If the C.H. stops frequently just short of "home" the gun can usually be made to fire by pushing it fully forward. Always release the trigger before doing this.

Note 2. Stoppages caused by defective feed mechanism can frequently be avoided by No. 2 assisting to pull the belt through the feed block. Only slight assistance is required.

(g) Special features and information of interest.

1. The sighting arrangements are very elaborate. The backsight slide has several-sized apertures and a semi-open sight which consists of a V-notch in a half moon aperture. To change from one type of aperture to another, push in the disc and rotate to the desired position.

2. In addition there are two battle sights, one for use with the sight horizontal and the other when it is vertical. The former presumably is for use at ranges up to about 500 yards, while the latter probably caters for a range of 1,000 yards or so. I have no certain information about it, but you can find out quite easily by trial and error.

3. There is a windage adjustment actuated by a thumb screw on the left side. The graduations are in mils and provide a deflection of from 0 to 20 on either side.

4. The graduation on the sight may be one of the following three:

0-2,600 yards, for .06 or M.2. ammunition.

0-3,400 yards, for M.1. ammunition.

0-2,800 metres.

5. There is an adjustment for drift on the backsight which is of the same type as in the Springfield rifle, i.e. the slide moves upwards at a slight angle to the left.

3. .256-INCH REVELLI MEDIUM MACHINE GUN (ITALY).

(a) Particulars.

Weight—less water.	37½ lbs.
Length.	Rather longer than the Vickers.
Method of operation.	Recoil and projection of spent case.
Locked or unlocked.	Semi-locked.
Feed.	Mouse trap type, 50-round magazine.
Ejection.	Upwards.
Type of fire.	Single shot or auto.
Rate of fire.	500 r.p.m.
Sights.	Open.
Range of adjustment.	0-2,000 metres.

(See Fig. 17, p. 158).

(b) Brief description.

I have not had an opportunity of examining a Revelli in detail for some fourteen years, and since my notes are not now available, fully detailed information is impossible at the moment.

The main feature of interest is the magazine. This consists of a long rectangular box divided into ten compartments, each of which holds five rounds. The magazine is inserted from the left side. At the end of each five rounds a projection on the rear of the magazine compartment platform raises a pawl which, during the previous rounds of that compartment, had prevented the feed-over ratchet arm from pushing the magazine over. The lifting of the pawl allows the feed-over ratchet arm full play and the magazine is shifted over to the right by one compartment.

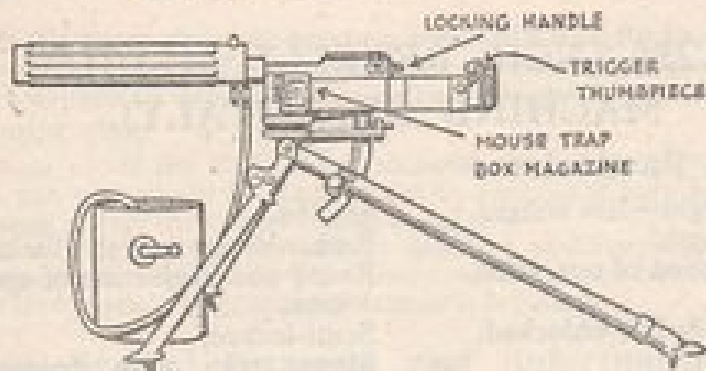

REVELLI MEDIUM MACHINE GUN

FIG. 17.

There is an inspection cover for the mechanism on the right side. The catch for this is also on the right. Pull this out and pull the plate back to inspect.

Stripping should be commenced by pressing down the catch of the rectangular body locking-pin (right side), and pushing out the pin from left to right.

4. 8 mm. FIAT-REVELLI MEDIUM MACHINE GUN, MODEL 35 (ITALIAN).

Note. This is a modified version of the old 6.5 mm. water-cooled gun used by the Italians in the war of 1914-1918. (See No. 3, page 157.)

(a) Particulars.

Weight of gun.	39½ lbs.
.. of mounting.	50 lbs.
Length.	49½ ins.
Method of operation.	{ Recoil and projection of spent case.
Locked or unlocked.	Semi-locked.
Feed.	{ Belt. Lengths of 50 rounds which can be joined together.
Ejection.	Upwards.
Type of Fire.	Single shot or auto.
Rate of fire.	600 rounds per minute (cyclic).
Sights.	{ V backsight, barleycorn foresight.
Range of adjustment.	200-2400 metres.

(See Fig. 17A, p. 159A.)

(b) Loading and unloading.

(1) To load.

1. Insert belt into feed-block from left side, pull as far as possible to right, and cock the gun by pulling back the

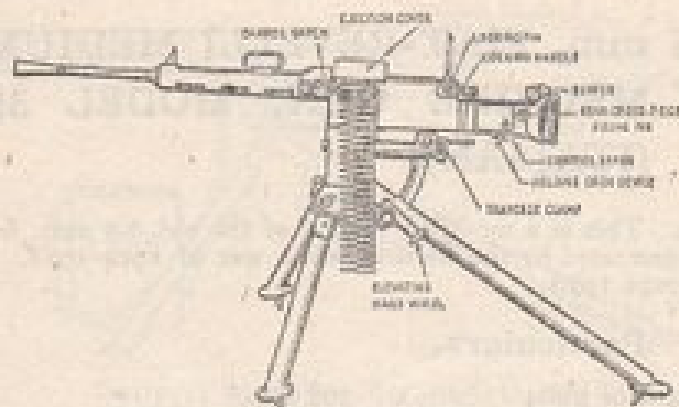

FIAT (REVELL) MEDIUM MACHINE GUN, Model 36.

FIG. 17A.

cocking-handle at rear of the breech-block and allowing it to go forward again.

2. Move change lever to vertical position marked **SICURA** (safe).

(II) To prepare to fire.

1. Set change lever to left for single shot or to right for automatic.

2. Set control lever, on left of body, vertical for slow rate and horizontal for rapid rate of fire.

(III) To unload.

1. Depress release lever on right side of feed-block and pull belt out to left.

2. Pull cocking-handle back and let go, twice.

3. Press trigger to ease spring.

(c) Stripping and Assembling.

(I) To strip.

Operation No.	Most Convenient Position of Gun.	Operation.
1.	Vertical.	Remove barrel as follows: Push in barrel catch on left side, rotate barrel handle to left of slot, push barrel forward till breech is clear of barrel casing; lift up rear of barrel out of slot, turn handle to right of slot and withdraw muzzle end through front opening.
2.	"	Remove rear cross-piece fixing pin by pushing down retaining catch and pushing pin out to left. Drop rear cross-piece.
3.	On left side.	Pull out cover catch on right side and withdraw cover to rear. (Note. A raw-hide mallet may be necessary.)
4.	"	Remove pawl release lever by lifting pawl and rotating rear end of release lever up until feather way coincides.
5.	"	Depress feed pawl lever actuating spring and rod, turn until feather coincides and remove.
6.	"	Push feed block cover upwards until free, then lift out.
7.	"	Remove spring feed lever, remove pin axis, retaining feed lever by pushing up small catch and turning back and to the left.
8.	"	Remove feed lever by putting thumb on slide, raise it, and remove lever through feed block.
9.	"	Remove tensioning lever of feed lever spring.
10.	"	Remove return spring and connecting rod by pushing up rear end with screw-driver.

Operation No.	Most Convenient Position of Gun.	Operation.
11.	On left side	Remove wedge axis pin by lifting up, and remove wedge.
12.	"	Depress catch of key tensioning main-spring and remove catch to the right.
13.	Vertical	Withdraw breech-block to the rear (complete with firing-pin and spring).
14.	"	Remove firing-pin and spring from breech block.
15.	"	Withdraw feed block to the left.
16.	"	Remove barrel extension to the rear.
17.	On left side.	Remove accelerator.
18.	"	Disconnect safety sear spring.
19.	"	Remove trigger by lifting up and at same time push in trigger bar from rear end.
20.	"	Remove trigger bar and spring to rear.
21.	"	Remove axis pin of the firing and safety sears by pushing up with forefinger from under side. Remove sears.
22.	"	Lift out oil pump actuating lever.
23.	"	Push in oil pump retainer on the right side and turn until the feathers coincide, and lift out.
24.	Vertical.	Turn catch on left side to the left and remove.
25.	"	Remove pump.

(ii) To Assemble.

Reverse the order given in "Stripping," paying attention to the following points:—

Corresponding No. in "Stripping" Procedure.	Position of Gun.	Notes.
25. Pump.	Vertical.	1. When replacing the pump make sure that base of the cone opening in the pump is to the left.
24. Pump Catch.	"	
23. Oil Pump Retainer.	On left side.	
22. Oil Pump actuating lever.	"	2. When replacing oil pump actuating lever see that the attached spring (safety sear spring) is towards the front of the gun.
21. Sears.	"	3. The sears should be replaced together. Make sure that drilled projection on the oil pump actuating lever is lying in the recess at the rear of the safety sear.
20. Trigger bar and spring.	"	4. When replacing trigger bar, assemble spring to bar before insertion. The flat on the forward end of the trigger bar should be to the right of the gun. Great care is needed that the flat lies absolutely vertical.
19. Trigger.	"	5. When replacing trigger push the back end of the trigger bar inwards to allow the pin on the trigger to fit in the hole on the trigger bar. Be careful not to push the trigger bar too far forward or the front end of the trigger will foul the single shot trip plunger of the firing sear.

<i>Corresponding No. in "Stripping" Procedure.</i>	<i>Position of Gun.</i>	<i>Notes.</i>
18. Safety sear spring.	On left side.	
17. Accelerator.	"	6. When replacing accelerator, place the pin in its axis hole but leave the top of the accelerator clear of its recess in the body for the time being.
16. Barrel Extension.	Vertical.	7. When replacing barrel extension both sears must be depressed twice, viz.: (i) To clear the flat immediately below the ejector. (ii) To clear rear end of the wedge recess. After clearing the wedge recess, lift the top of the accelerator into its recess in the body and complete forward movement on the barrel extension. This enables the top of the accelerator to assume its correct position in the barrel extension. DO NOT PUSH COMPLETELY FORWARD BUT LEAVE APPROX. $\frac{1}{2}$ INCH PROJECTING TO ALLOW FREE ENTRY OF THE FRED BLOCK.
15. Feed block.	"	
14. Firing-pin and spring	"	
13. Breech-block complete.	"	
12. Key tensioning main spring.	On left side.	8. To replace key tensioning main spring, depress both sears by means of a screw-driver and push forward the firing-pin; insert the key in its recess

<i>Corresponding No. in "Stripping" Procedure.</i>	<i>Position of Gun.</i>	<i>Notes.</i>
11. Wedge.	On left side.	behind the main spring from the left side, depress catch on right and push home until the catch engages. 9. (i) Before replacing wedge connect front end of connecting rod to wedge, push back barrel extension slightly from front end to allow wedge to seat itself in recess. (ii) When replacing wedge and wedge axis pin, it should be noticed that the axis pin has three possible positions. This is to allow control of resistance to recoil. The axis pin has its bearing surface made eccentric and the binding of the wedge in the barrel extension is thereby increased or decreased according to which position is selected.
10. Connecting rod.	"	10. When replacing connecting rod use a screw-driver to lever the connecting rod into its seating on the underside of the body. Leverage can be applied to the bottom of the safety sear opposite the axis pin.
9. Tensioning lever.	"	
8. Feed lever.	"	
7. Feed lever pin.	"	11. Before replacing feed lever lift up slide and insert through feed block with roller in centre of feed slide recess. 12. Replace feed lever key pin with catch towards left side of gun and slightly forward. This ensures the flat of the pin assuming the correct position. Rotate pin to rear, at the same time

Corresponding No. in "Stripping" Procedure.	Position of Gun.	Notes.
6. Feed block cover.	On left side.	depress the catch and complete movement until the pin points to the right and the catch engages.
5. Feed pawl lever actuating spring and rod.	"	13. When replacing feed lever spring connect to feed lever first.
4. Pawl release lever.	"	14. When replacing feed pawl lever actuating spring and rod push in against the spring and rotate half a turn.
3. Cover.	"	
2. Rear cross piece and pin.	Vertical.	
1. Barrel.	"	

(d) General remarks and points of interest.

1. Since this weapon is air cooled it will be necessary to change the barrel after firing for about 3 minutes at the rate of 120 rounds per minute. Every effort should be made to cool the discarded barrel.

2. As the weapon depends partly upon projection of the spent cartridge case for its functioning lubrication of the moving parts is essential and should be resorted to as soon as any malfunctioning occurs.

5. 8 mm. SCHWARZLOZE MEDIUM MACHINE-GUN (AUSTRIA).

(a) Particulars.

Weight—less water.	44 lbs.
Length.	About the same as the Vickers.
Method of operation.	Projection of spent case.
Locked or unlocked.	Strictly unlocked (see description below).
Feed.	Fabric belt—right to left.
Ejection.	Left side.
Type of fire.	Auto only.
Rate of fire.	400 rounds per minute.
Sights.	Open.
Range of adjustment.	0-2,000 metres.

(See Fig. 18, p. 161.)

(b) Brief description.

Here again only a brief description is possible. The main features are as follows:

1. Unlocked breech. Opening is, however, delayed by the fact that:

- (i) The moving parts are very heavy and massive.
- (ii) There is a strong recoil spring.
- (iii) The barrel is short so bullet exit is quicker than in other guns of similar category.
- (iv) The axes of parts which must rotate round one another are more or less in the same horizontal plane, and a certain amount of inertia has to be overcome.

2. Three backward movements of the crank handle are necessary in order to load. The belt is fed up over a toothed wheel, and not till the third movement is a round presented to the chamber.

MEDIUM MACHINE-GUNS

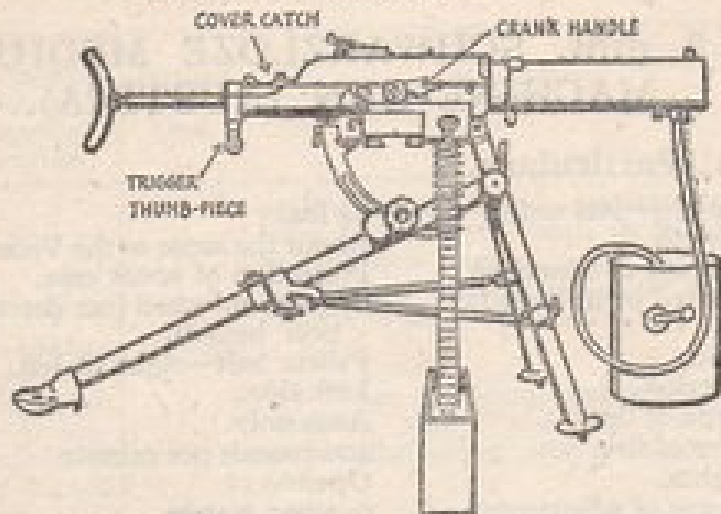

Schwarzloze Medium Machine Gun.

FIG. 18.

3. Firing arrangements. To fire push automatic safety-catch over to the left and push thumb-piece of firing-lever inwards.

4. Automatic oiling device in the cover.

(c) Brief notes on how to commence stripping.

1. Unscrew body locking-pin on rear of gun just above and to the right of the trigger.

2. Rotate end cap and butt handle group about 45 degrees to right and withdraw to rear.

Note. Beware of strong recoil spring.

3. Remove spring to rear.

4. Remove firing-pin and other breech components.

CHAPTER IV

MACHINE CARBINES

1. .45-INCH THOMPSON MACHINE CARBINE

(a) Particulars.

Service designation.
Method of operation.

Thompson Machine Carbine.
Projection of spent case.

Locked or unlocked at
the moment of firing.

Not locked, but on the other hand not in the same class as the simple "blow back" type of weapon. Breech opening is delayed by the adhesion of slipping inclined faces. (Blish system.)

Weight.

10 lbs approx.

Length.

33½ ins.

Capacity of magazine

{ Drum 50 rds. (obsolete).
Box 20 rds.

Type of Fire.

Change lever for "single shot"
or "auto."

Rate of fire.

600-700 r.p.m.

Type of sights.

Aperture.

Range of Adjustment.

0-600 yds.

(See Fig. 19, p. 163).

(b) Loading and unloading.

(i) To fill magazines.

(a) DRUM TYPE. Remove the winding-key by lifting up the flat spring, thereby disengaging its stud from the centre piece, and sliding the key sideways out of engagement with



Thompson Machine Carbine

FIG. 19.

the two slots on either side of the centre piece. Lift off the cover of the magazine. Fill by placing five rounds base downwards in between each claw of the rotor. Load up anti-clockwise and fill the outer spirals first. When it comes to the last compartment, position the rotor with one claw opposite the mouth of the magazine. Replace the cover with the slot in the side over the projecting stud on the bottom left half of the magazine. Slide on the winding-key making sure that the stud on the flat spring is correctly engaged in the centre piece. Wind clockwise nine clicks (or as otherwise indicated on the magazine).

(b) **Box Type.** Hold the magazine in the left hand, mouth uppermost, and base against the body. Place rounds singly on top of the platform or preceding round with the right hand, and press down into the magazine with the left thumb (i.e. as for hand filling of Bren thirty-round magazine).

(ii) To load.

(a) **DRUM MAGAZINE.** *Cock the weapon.* With the winding-key to the front, insert the two ribs of the magazine into the horizontal grooves in the front of the body from the left side. Force the magazine over to the right until the

magazine-catch engages. The magazine can be put on from right to left, but forcing it home from this direction is liable to strain the magazine-catch.

N.B. The drum magazine cannot be put on the carbine when the moving parts are in the forward position. This is due to interference between the underside of the bolt and the magazine mouth.

(b) **Box Type.** *Cock the weapon.* Insert the rib on the back of the magazine in the corresponding recess in the body in front of the trigger-guard, and force upwards until the magazine-catch engages.

N.B. The box magazine can be put on when the moving parts are forward, i.e., with the carbine uncocked, but great care is necessary to ensure that the magazine-spring has to be taken up before engagement is positive. This course is not recommended.

(c) Set change lever at "R" or "A" according to type of fire desired. R = single shot (repetition) and A = automatic.

N.B. The change lever can only be moved when the weapon is cocked.

(iii) To unload.

(a) To remove either type of magazine, press up the thumb-piece of the magazine-catch on the left side of the body and remove the magazine—drum type to the left, box type downwards.

(b) Press trigger and ease moving parts forward under control.

(c) Stripping and assembling.

(i) To Strip.

1. Change lever must be set at "auto."* If not already there, cock weapon, move change lever, press trigger, and ease moving parts forward under control.

* If you attempt to strip the weapon with the change lever in any other position, you will jam the trigger mechanism against

the breech-block. Such a jam can only be rectified by forcing the change lever downwards and forwards to the auto position. This should only be done by the unit armourer.

2. Press down butt plunger and slide butt off body to the rear.

3. Press up plunger on underside of body behind pistol grip group, press trigger and draw pistol grip group off to the rear.

4. With the carbine upside down on a table, slip the tool removing return spring over the spring and rod immediately behind the breech-block; pull the rod collar towards the breech-block, releasing the bar of the rod from its seating in the body. Withdraw return spring and rod.

5. Push cocking-handle back to its rear position and lift out breech-block.

6. Pull cocking-handle forward again and lift out "H" piece.

7. Return cocking-handle to rear position and withdraw.

(ii) To assemble.

1. Replace cocking-handle in rear position and pull forwards.

2. Replace "H" piece, sliding the two trunnions down the inclined ramps in the body and the cross-piece into the jaws of the cocking-handle.

N.B. When you do this, see that the word "Up" on the "H" piece is uppermost.

3. Push the cocking-handle and "H" piece to the rear position and insert breech-block:

(i) With bolt portion in its recess in the front of the body, and

(ii) With the inclined cuts on the block portion coinciding with the side members of the "H" piece.

4. Return cocking-handle, "H" piece and breech-block to the forward position.

5. Assemble return spring to return spring rod.

6. Put front end of spring in its housing in the rear of the breech-block.

7. Slip "tool removing and assembling return spring" over the spring immediately in rear of the breech-block. This is to control the spring which wants to coil itself when unsupported.

8. Carefully compress the spring by forcing the front of the return spring rod through the spring and into the tool.

9. Keeping control of tool, spring and rod, slip the rear end of the rod into its seating in the rear of the body.

N.B. While doing so, ensure that the flat portion of the collar on the rod is downwards; otherwise the rod cannot be assembled.

10. Re-assemble pistol grip from the rear.

11. Replace butt from rear.

(d) Stoppages and immediate action.

In the event of a stoppage, apply the following immediate action:

(i) Cock.

(ii) Remove magazine and change it for another.

(iii) Continue firing.

If you have time, which is unlikely on service, or are on the range, instead of changing the magazine, proceed as follows:

(i) Examine magazine mouth—if round correctly placed.

(ii) Replace magazine and continue firing.

If at (i) above a round is misplaced, remove it, replace magazine and continue firing. If similar stoppages continue, strip and clean, and oil up at the first opportunity. In conditions of sand or dust use only a minute amount of oil on the bearing surfaces of the "H" piece.

(e) Special features and information of interest.

The fifty-round magazine should not be used on patrol work where silence is of primary importance. When full, the rounds rattle in the magazine casing and can be heard for some distance. In addition it is by no means easy to change fifty-round magazines quickly.

2. 9 mm. STEN MACHINE CARBINE

(a) Particulars.

Service designation.	Sten Machine Carbine. Mark I, II or III.
Method of operation.	Projection of spent case.
Locked or unlocked at moment of firing.	Unlocked. Simple blow-back action.
Weight, without magazine.	Mark I, 8 lbs. Mark II, 6½ lbs. Mark III, 6 lbs. 6 ozs.
Length.	Mark I, 35 ins. Mark II 30 ins. Mark III, 30 ins.
Magazine Type.	Box.
Capacity.	32 rounds.
Weight filled.	1½ lbs.
“ empty.	10½ ozs.
Type of fire.	Single shot or automatic.
Rate of fire (cyclic)	500-550 rounds per minute.
Sights.	Fixed aperture backsight, barleycorn foresight (fixed range, 100 yds.).
Ammunition.	9 mm. All types of Parabellum and most other 9 mm. cartridges can be used in this weapon. (See note on p. 10).

(See Fig. 20, p. 169).

(b) Loading and unloading.

(1) To fill magazines.

Slip the filler on to the magazine, place the base of the magazine against the body and whilst working the filler lever with one hand place cartridges, base first, into the hollow of the lever with the other. Work the lever with a smart, firm movement.

MACHINE CARBINES

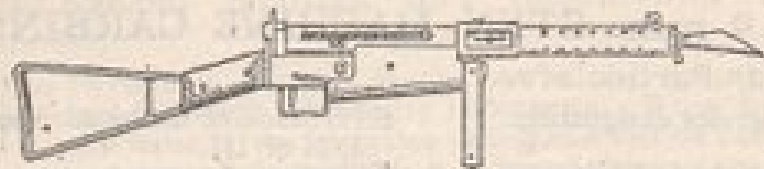

MARK I

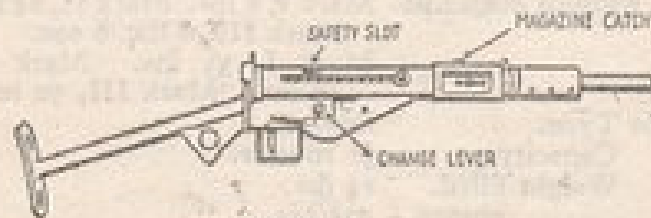

MARK II



MARK III

STEN MACHINE CARBINE

FIG. 20.

MACHINE CARBINES

(II) To load.

1. Insert the magazine in the magazine housing, and push home until you are certain that the magazine catch has engaged.

2. Pull back the cocking handle and, unless fire is to be opened at once, slip it into the safety slot.

Note. The breech-block should NEVER be left forward when a filled or partly filled magazine is in the carbine, since, if this is done and the weapon is jerked sharply, a round may be fired unintentionally.

3. Push change lever to Right for Single Shots (R) or to Left for Automatic (A).

(III) To unload.

1. Grasp the magazine with the fingers of the left hand; press down the magazine catch with the left thumb, and at the same time withdraw the magazine from the housing.

2. Press the trigger and ease the breech-block forward under control.

(c) Stripping and assembling.

(I) To strip.

1. Press in the boss on the return spring-housing and slide butt downwards and remove.

2. Press in return spring cap and twist anti-clockwise as far as possible; remove cap, housing and return spring.

3. Pull back cocking handle as far as safety slot, rotate breech-block slightly in body until cocking handle can be withdrawn; tip muzzle of weapon upwards and breech-block will slide out.

(II) Further stripping.

1. Mark I only.

(i) Unscrew the two screws on the right of the front end of the barrel casing.

(ii) Pull out the flash eliminator and the barrel may thus be removed from the casing.

2. Mark II only.

(i) Pull out magazine housing plunger and rotate magazine housing downwards about the body.

(ii) Unscrew barrel nut and remove barrel nut and barrel.

Note. No other stripping is normally necessary or desirable, except by an armouress.

(III) To assemble.

1. Replace barrel (Marks I and II only).

(i) Mark I only. See that the barrel is fully home in its seating and that the screws are tight.

(ii) Mark II only.

(a) See that the barrel nut is screwed home, that the magazine housing is rotated upwards as far as possible and that the teeth of magazine housing plunger are engaging in the teeth around the barrel nut.

(b) In nearly every case a number or a line will be found stamped on the barrel. Whenever this is so the number or line must be aligned with the foresight as otherwise the accuracy of the weapon will be affected.

2. Slip the breech-block into the body; ease it forward and rotate until the cocking handle can be inserted fully (at the junction of the main slot with the safety slot); press the trigger and ease the breech-block fully forward. Do not let it drop forward by reason of its own weight.

3. Assemble return spring, return spring-housing and return spring cap and replace in body, pushing cap lugs into recesses and turning cap clockwise as far as possible.

4. Slide butt into place, ensuring that the boss on the return spring-cap is fully home in the hole in the front butt plate.

(d) Stoppages and immediate action.

If the weapon stops the following I.A. must be applied:

(i) Pull back cocking handle.

(ii) Remove magazine and insert a full one.

(iii) Continue firing.

If you have time, which is unlikely in action, before exchanging magazines look at the mouth of the one you have just removed from the carbine. Should there be cartridges still in it, and if the top round is not misplaced, reload and carry on. If the top round is misplaced, remove it, reload and carry on.

If on pressing the trigger after carrying out I.A. the breech-block does not go fully forward, pull back the cocking handle, turn the carbine over to the right and shake it. This should remove any empty case not previously ejected.

(e) Special features and information of interest.

1. With Marks I and II care must be taken that the left hand grips the barrel nut well forward so that none of the fingers enter the ejection opening and become trapped by the breech-block—a painful proceeding. In the Mark III a small flange in front of the ejection opening makes it unlikely that this can occur.

2. Unlike the Thompson it is not necessary to oil this weapon to ensure functioning: in fact, the Sten will continue to fire although bone dry. This does not mean, however, that the ordinary rules for the care of weapons should be relaxed: the weapon which is well cared for will always function more reliably than one which is badly treated.

3. 9 mm. SOLOTHURN MACHINE CARBINE

(a) Particulars.

Method of operation.	Projection of spent case.
Locked or unlocked.	Unlocked. Simple blow back action.
Weight (without magazine).	9 lbs. 7 ozs.
Length.	32½ inches.
Capacity of magazine.	30 or 32 rounds. Box magazine.
Type of fire.	Single shot or auto.
Rate of fire.	700 rounds per minute.
Type of sights.	Open.
Range of adjustment.	0-500 metres.
Ammunition.	Parabellum type (See note on p. 10).

(See Fig. 21, p. 174).

(b) Loading and unloading.

(i) To fill magazines.

Proceed as for the Thompson box magazine.

(ii) To load.

Insert mouth of magazine in magazine housing, and press home until the catch engages. Pull back the cocking-handle.

(iii) To unload.

Press in the magazine-catch which is situated on the rear side of the magazine housing, and withdraw the magazine. Press the trigger.

(c) Stripping and assembling.

(i) To strip.

1. Press down stud on cover behind backsight and at the same time push in catch on rear of cover. This allows cover to be raised.

2. With right hand pull back cocking-handle slowly, and, as soon as the narrow portion of the bolt appears, grasp bolt with left hand. Hold firmly and complete backward movement of cocking-handle.

3. Lift front end of bolt, being careful not to let bolt fly forward out of control under the influence of recoil spring and rod.

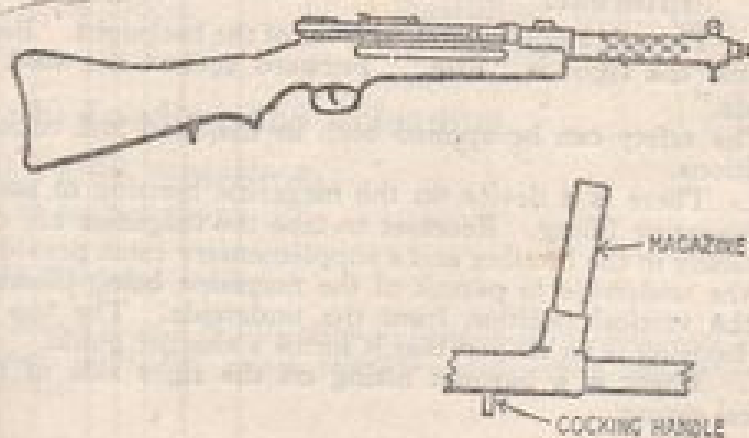

FIG. 21.

(ii) To assemble.

1. See that cocking-handle is forward.
2. Insert recoil spring rod into its recess.

3. Turn bolt so that tongues are to right and the flat is underneath.

4. Push bolt back, compressing recoil spring. When sufficiently far back to allow of assembly of bolt, lower the latter into position. When correctly placed in the body, leave go of the front end of the bolt allowing it to go forward under the influence of the spring. Keep a downward pressure on the top of the bolt to prevent it rising.

(c) Stoppages and immediate action.

Normal immediate action for machine carbines, all of which are very similar with regard to basic principles of operation and feed. (See Thompson.)

(d) Special features and information of interest.

1. There is a safety-catch in front of the backsight. Back against the sight is "Fire." Forward against the stud is "Safe."

The safety can be applied both in the fired and cocked positions.

2. There is a device on the magazine housing to assist in magazine filling. Recesses to take the magazine are cut vertically in the housing and a supplementary catch provided on the underside to permit of the magazine being inserted in the vertical position from the underside. The top of the housing is so shaped that it forms a charger guide.

3. There is a bayonet fitting on the right side of the barrel casing.

4. 9 mm. SCHMEISSER MACHINE CARBINE. M.P. 40.

(a) Particulars.

Method of operation.	Projection of spent case.
Locked or unlocked.	Unlocked. Simple blow-back action.
Weight.	9 lbs. 6 ozs.
Length.	33½ ins.
Capacity of magazine.	32 rounds.
Type of fire.	Single shot or auto.
Rate of fire.	500-600 rounds per minute.
Type of sights.	Open.
Range of adjustment.	100-1,000 metres.
Ammunition.	Parabellum type. (See note on p. 10).

(b) Loading and unloading.

(i) To fill magazines.

As for Solothurn.

(ii) To load.

Insert mouth of magazine in magazine housing, and press home until the catch engages. Pull back the cocking-handle.

(iii) To unload.

Press in the magazine catch, which is situated on top near side of the magazine housing, and withdraw the magazine. Press the trigger.

(c) Stripping and assembling.

(i) To strip.

1. Press in catch at rear of body.
2. Hinge up body.
3. Turn recoil spring cap 45 degrees anti-clockwise and withdraw together with recoil spring.
4. Lift up rear end of lever which protrudes into the left side of the bolt way, and withdraw bolt and firing-pin.

(ii) To assemble.

1. Insert bolt and firing-pin into rear of body.
2. Push forward plunger at rear of trigger mechanism underneath the body, and clear sear out of the way of the bolt. (The plunger is what the trigger pushes forward.)
3. Turn cocking-handle up into its own groove and push bolt forward.
4. It will be held up again by the bents of the bolt and sear engaging. Therefore again push forward the plunger and push the bolt home.
5. Insert recoil spring with end cap attached; with catch on cap at about 45 degrees to the left, get the cut-away portions of end cap and body coinciding and turn end cap to the vertical when it will lock into place.
6. Snap action up to the body.

(d) Stoppages and Immediate Action.

Normal immediate action for machine carbines. (See Thompson.)

(e) Special features and items of interest.

1. There is no safety-catch in the accepted sense of the

word. On top of the cocking-handle operating slot in the body there is a small slot recess in rear of the cocked position. When the cocking-handle is turned into this the weapon is at "SAFE." The safety slot is marked "S."

2. Selection of single shot or auto is brought about by a transverse slide just above the rear of the trigger group. When the catch projects to the right single shots are fired; when pushed out to the left, the sear is not tripped and the weapon fires fully automatic.

5. GERMAN PARACHUTE TROOPS MACHINE CARBINE (Schmeisser Type). M.P.38. 9^{mm}

(a) Particulars.

Method of operation.	Projection of spent case.
Locked or unlocked.	Unlocked. Simple blow back action.
Weight.	9 lbs.
Length.	25 ins. when butt is folded.
Capacity of magazine.	32 rounds.
Type of fire.	Automatic only.
Rate of fire.	500-540 rounds per minute.
Type of sights.	Open. Very thick blade foresight, and square notch backsight.
Range of adjustment	Two flip-up leaves calibrated for 100 and 200 metres.
Ammunition.	9 mm. Parabellum type. (See note on p. 10.)

(See Fig. 22, p. 180.)

(b) Loading and unloading.

As for Schmeisser.

(c) Stripping and assembling.

(i) To strip.

1. Pull out rather more than a quarter of an inch the milled-headed round stud on the bottom front portion of the body, and turn a little to keep unlocked.

2. Grasp barrel with left hand and pistol grip with right; pull trigger and twist pistol grip through about 80 degrees anti-clockwise, and remove pistol grip group.

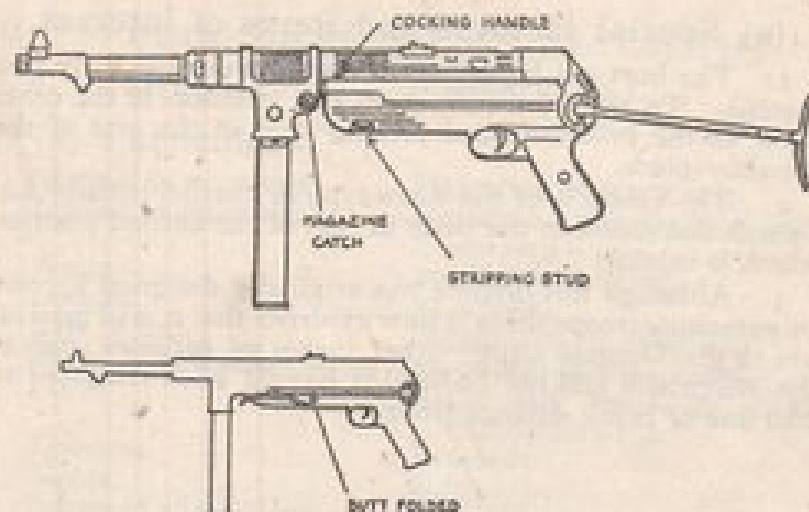

GERMAN PARACHUTE TROOPS MODEL
MACHINE CARBINE - SCHMEISSER TYPE

FIG. 22.

3. Pull back cocking-handle; recoil spring complete and striker and bolt will appear, and can be removed.

(ii) To assemble.

Reverse the above order.

Note. The barrel can be removed with a special tool or with a spanner.

(d) Stoppages and immediate action.

Normal immediate action for machine carbines. (See Thompson.)

(e) Special features and items of interest.

1. The butt can be folded forwards under the body (see sketch). To shift the butt from one position to the other press in the milled-headed locking stud at the end of the shoulder-piece.

2. The safety is of the same type as the Schmeisser, i.e. a small slot recess in the body in rear of the cocked position which is marked "S."

3. Although this carbine was originally designed for use by parachute troops there is now evidence that it is in general use in the German army—other makes of carbines such as the Bergmann and the Solothurn having been relegated to 2nd line or home defence troops.

6. 9 mm. BERGMANN MACHINE CARBINE. (GERMANY.)**(a) Particulars.**

Method of operation.	Projection of spent case.
Locked or unlocked.	Unlocked. Simple blow back action.
Weight.	10½ lbs. with sling.
Length.	33 inches.
Rate of fire.	Single shot or automatic.
Capacity of magazine.	32 rounds (normal) box.
Feed.	Right side magazine points slightly forward.
Ejection.	Left side.
Sights.	Open.
Range of adjustment.	50-1,000 metres.
Ammunition.	Parabellum type. (See note on p. 10).

(See Fig. 23, p. 183.)

(b) Loading and unloading.**(i) To fill magazine.**

Normal for machine carbines.

(ii) To load.

This weapon has a bolt lever which, in order to cock it, must be manipulated in the same manner as the lever of a rotating bolt action rifle.

Insertion of magazine in its housing on the right side is normal.

(iii) Unloading.

Press in catch which is on the near side of magazine housing and remove magazine. Press trigger.

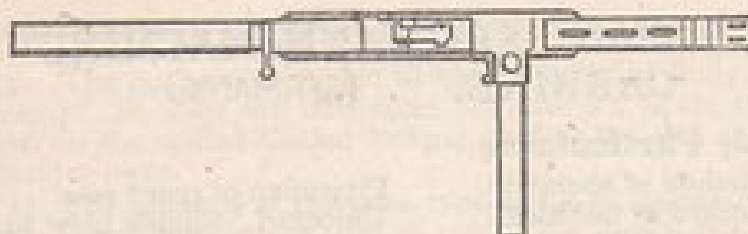

BERGMANN

FIG. 23.

(c) Stripping and assembling.**(I) To strip.**

Press down projecting vertical catch on left side of body, raise bolt lever and withdraw bolt complete to the rear.

(II) To assemble.

Reverse the above, and press trigger.

(d) Special features and information of interest.

1. Safety is on left side of body. "S" for "SAFE" is forward, while "F" for "FIRE" is with catch to rear.
2. A double trigger which acts in the following manner:
 - (i) A light pull on the main or forward trigger does not operate the secondary or rear trigger, and single shots are fired.
 - (ii) By pulling right through to the rear with the main trigger, the secondary one is brought into action, and fully automatic fire is produced.

7. 9 mm. BERETTA MACHINE CARBINE (ITALIAN).**(a) Particulars.**

Service designation.	Moschetto auto Model, 38.
Method of operation.	Projection of spent case.
Locked or unlocked at moment of firing.	Unlocked, simple blow-back action.
Weight without magazine.	9½ lbs.
Feed	Underneath magazine.
Magazine.	Box type.
Capacity of Magazine.	Three types: 10, 20 and 40 rounds.
Length over-all.	37½ ins.
Type of fire.	S.S. or auto.
Rate of fire.	550-600 r.p.m.
Type of sights.	Open.
Ammunition.	9 mm. Parabellum. (See note on page 10.)

Note. This weapon is fitted with two triggers—the front one for single shots and the rear one for automatic fire. The rear trigger can be locked against accidental use by pushing a transverse plunger situated immediately above it, from left to right.

(See Fig. 23A, p. 184A.)

(b) Loading and unloading.**(i) To fill magazine.**

Usual procedure—no special remarks.

(ii) To load.

Insert full magazine in magazine housing in front of the trigger-guard, and press home until the magazine-catch clicks.

N.B. The magazine catch is situated just in front of the trigger-guard.

(III) Unloading.

Press in magazine-catch and remove magazine. Press trigger.

(c) Stripping and assembling.**(i) To strip**

1. Press in the stud at the rear of the body and turn the rear-end cap until the arrow on it is in line with the register mark on the top of the body. Remove the end cap.



9 mm. BERETTA MACHINE CARBINE

(Italian)

FIG. 23A.

2. Pull back the cocking-handle as far as possible and remove the breech-block and return-spring tube from the weapon.

3. Push the return spring tube into the breech-block just far enough to ease the pressure on the sliding catch on the rear of the breech-block, and push the sliding catch over until the key way in it coincides with the lug on the return-spring tube. Remove tube and spring under control.

4. Slide back the milled slide on the under side of the breech-block, thus releasing the striker keeper cam, which in turn releases the striker. Remove striker rod and striker.

5. No further stripping is normally necessary or desirable.

(ii) To assemble.

1. Insert striker and striker rod, ensuring that the milled "flats" at the rear of the latter are horizontal and that the striker keeper cam engages in the space in rear of the striker. Push the striker rod home till its end is flush with the rear of the breech-block and slide the milled slide forward to hold the striker keeper cam in position.

2. Insert return spring and return-spring tube in breech tube in breech-block taking care not to allow the spring to become buckled. As soon as the lug on the tube has passed the sliding catch push the latter to the closed position.

3. Insert breech-block complete in body, and allow to move right forward by pressing one of the triggers. The cocking-handle, if in the rear position, will be carried forward by the breech-block.

4. Push the rear-end cap over the end of the body with the arrow uppermost and when fully forward twist arrow towards right side of weapon until it locks in position.

CHAPTER V

REVOLVERS AND AUTOMATIC PISTOLS

Preliminary.

The term "pistol" is used in the army as a general one, and is taken as meaning either a "revolver" or an "automatic pistol."

Any pistol, owing to the short length and the ease with which it can be pointed in any direction, is dangerous to both friend and foe alike if improperly handled. This dictum holds good even when it is being handled by an expert. In the hands of the fool or the man who knows little about it, it is much more likely to be dangerous to his comrades than to the enemy. For these reasons I make no apology for setting out below certain time-honoured precepts which should invariably be observed when handling pistols. The observance of these rules prevents accidents; neglect of them will one day lead to an accident and subsequent useless regrets.

The following rules must always be observed:

- (i) *Never* leave a loaded pistol lying about where other people can get at it without your knowing about it.
- (ii) When laying a pistol down, *always* "break" it or "open" it, if a revolver, or take out the magazine and clear the chamber if an automatic.
- (iii) If you want to pick up someone else's pistol, *never* do anything with it until you have proved that it is unloaded. If it is loaded, unload it and kick the

REVOLVERS AND AUTOMATIC PISTOLS 186

- person who left it unattended the next time that you see him.
- (iv) When dealing with an automatic, *always* remove the magazine first before you clear the chamber. If you do not do this and look at the chamber first, the unloading of the round in the chamber will certainly be accomplished, but the next round from the magazine will be fed in in its place. Subsequent removal of the magazine will not clear the round in the chamber. Neglect of this precaution causes more accidents with automatics than any other misdemeanour.
 - (v) If, despite all warnings, you have left your pistol lying about, *always* treat it as someone else's when you pick it up again—see (iii) above. Another person, just as careless as you are, may have picked it up and it may not be in the same condition as when you left it. It is better to be sure than sorry.
 - (vi) Last but not least, *never* point a pistol, whether loaded or unloaded, at anyone unless you mean business.

1. .455-INCH WEBLEY REVOLVER Mk. VI

(a) Particulars.

Service designation.	Pistol No. 1.
Weight.	2 lbs. 6 ozs.
Length.	11½ ins.
Length of barrel.	6 ins. Earlier Marks have shorter barrels. Target models 7¼ ins.
Number of chambers.	Six.
Cylinder rotates.	Clockwise.

.455 INCH WEBLEY MARK VI.

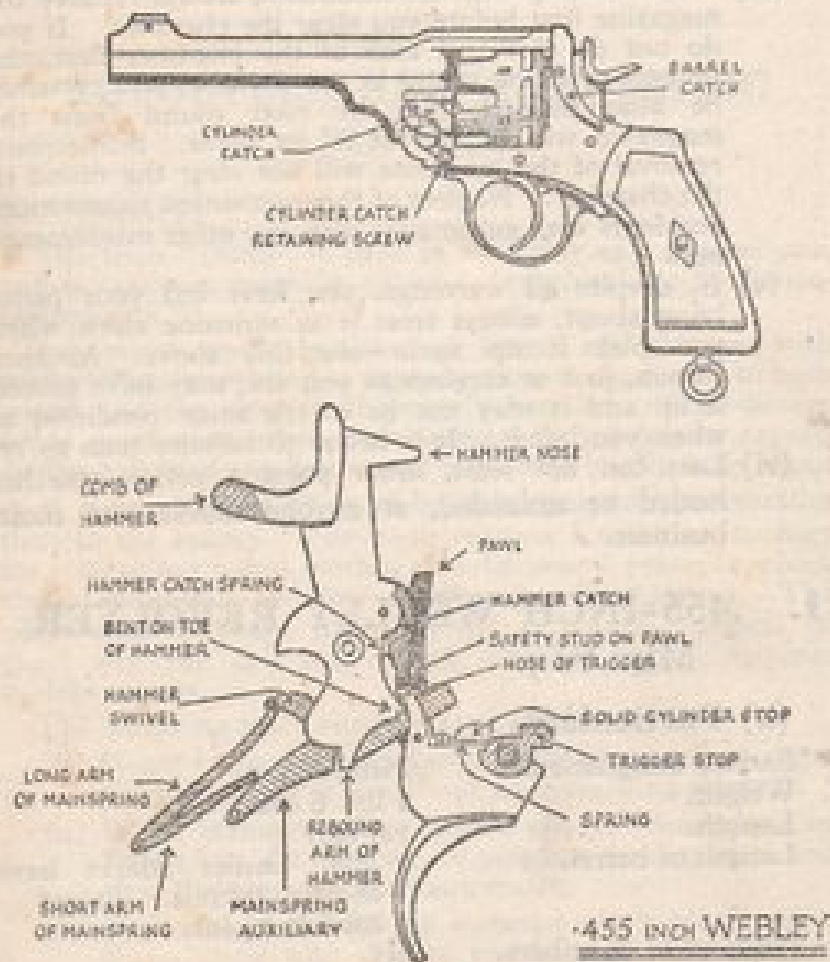

FIG. 24.

Ammunition

.455 inch Mk. II. For practice use only—lead bullet.
 .455 inch Mk. VI. For service use. This is nickel jacketed.

(See Fig. 24, p. 187.)

(b) Stripping and assembling.

(i) To strip.

1. Unscrew screw securing butt grips.
2. Unscrew trigger guard screws.
3. Push mainspring out of its seating from right to left, and unhook long arm from the hammer swivel.
4. Lift up tail of mainspring auxiliary from its seating and remove mainspring auxiliary.
5. Unscrew hammer axis screw and remove hammer.
6. Unscrew trigger axis screw and remove trigger complete with pawl.
7. Remove pawl from trigger.
8. With a coin unscrew the cylinder catch retaining screw; push bottom of cylinder catch retainer upwards, thus depressing rear of catch, and remove cylinder.

(ii) To assemble.

1. Reverse 8 above.
2. Replace hammer and hammer axis screw. Test for freedom of functioning.
3. Assemble pawl to trigger.
4. Replace trigger complete with pawl with the hammer forward; put in trigger axis screw one or two turns; test for functioning by pulling trigger and pushing it forward again.

189 REVOLVERS AND AUTOMATIC PISTOLS

The hammer should rise and fall freely. Repeat once or twice. If O.K., screw up trigger axis screw.

5. Replace mainspring auxiliary with its trunnions at the rear end in their seating. Test for functioning as in 4 above.

6. Hook the claws of the long arm of the mainspring on to the hammer swivel; place the top of the short arm on the top of the mainspring auxiliary, and lever the mainspring pin into its hole. Test for functioning by pulling the trigger. This time the trigger should recover under the influence of mainspring.

7. Replace trigger guard and screws.

8. Replace butt grips and screw.

(c) Notes on mechanism.

1. The cylinder is secured in the firing position by the pawl, engaged against the ratchet on the cylinder, preventing backward rotation; the solid stop on the trigger bearing against the end of one of the grooves at the rear of the cylinder prevents over rotation.

2. If the pistol is incompletely closed, either:

(i) The hammer is prevented from getting at the cap of the round by the barrel catch, which obviously cannot be properly engaged. or

(ii) The pistol is so far from being closed that the hammer cannot possibly reach the cap.

3. Rebound of the hammer is brought about by the inclined face of the short side of the mainspring auxiliary, under the influence of the mainspring, bearing against the tail of the hammer.

4. Mechanical safety is ensured by the tail of the hammer bearing against the short side of the mainspring auxiliary. Owing to the shape of the latter, a knock on the back of the

REVOLVERS AND AUTOMATIC PISTOLS 190

hammer causes the auxiliary to rise, and in doing so the long arm meets the safety-stud on the pawl, thus causing the pawl to rise. This then brings the trigger nose up until the latter becomes engaged against the hammer-catch, so preventing any further movement of the hammer, which cannot therefore reach the cap.

2. .380-INCH PISTOL No. 2.

(a) Particulars.

Service designation.	Pistol No. 2 Mk. I and I*.
Weight.	1 lb. 11½ ozs.
Length.	9½ inches.
Number of chambers.	Six.
Cylinder rotates:	Clockwise.
Ammunition.	British .380 in.

(See Fig. 25, p. 192.)

Note. The Mark I pistol can be fired either by cocking or pulling through. The Mark I* will only function by double action, i.e. by pulling through. In the later mark the comb of the hammer and the bent of the hammer have been abolished.

There are two marks of butt grip, Mark I and Mark II. The Mark II grips are somewhat fuller than the Mark I and have grooves cut in them to accommodate the thumb and trigger finger respectively.

(b) Stripping and assembling.

(I) To strip.

1. Unscrew cylinder retainer fixing screw and remove cylinder.
2. Unscrew screw securing butt grips and remove grips.
3. Unscrew barrel catch screw and remove barrel catch.

Note. Before unscrewing, the tension should be taken off the screw by compressing the spring. Do not use pliers.

4. Unscrew body plate screws on left side (4) and remove plate.
5. Lever back the top of the pawl and lift out.

PISTOL No. 2

FIG. 25.

6. Unhook mainspring from the hammer swivel and remove spring.
7. Knock out mainspring auxiliary fixing pin and remove auxiliary.
8. Rotate hammer backwards and remove.
9. Take out trigger and safety stop.
10. Take out cylinder stop and spring.

(II) To assemble.

Reverse the above order.

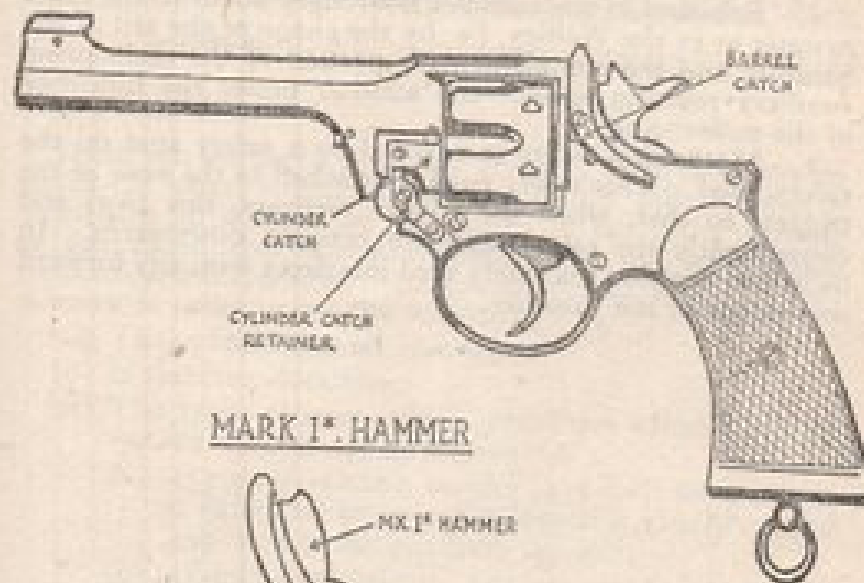
Note. When assembling the pawl, raise the mainspring auxiliary slightly, so that the latter rides on top of the pawl axis pin.

(c) Notes on Mechanism.

1. Rebound of the hammer is brought about in the same manner as in the Webley, i.e. by the shape of the tail of the hammer and the complementary portion of the mainspring auxiliary reacting against one another under the influence of the mainspring.

2. Mechanical safety is ensured by a safety stud on the safety pawl. This safety pawl is attached to the nose of the trigger, so that, when the trigger recovers, this pawl and consequently the safety stud are brought downwards. In its lowest position the safety stud interferes with any forward movement of the hammer.

3. COLT .455, .45, .38-INCH REVOLVERS

(a) Particulars.

There are so many different types of Colt revolvers in which the barrel-length, weight and calibre differ that it is impossible to summarise particulars in the same manner as for rifles and machine-guns. The following three particulars will, however, tell you almost all you will want to know in order to use the weapon:

- (i) The cylinder has six chambers.
- (ii) It revolves clockwise.
- (iii) The types of ammunition which are suitable for the various calibres are as follows:
 - (a) .455-inch—British service .455-inch ammunition or American ammunition which is clearly marked .455-inch as distinct from .45-inch.
 - (b) .45-inch—American .45-inch revolver ammunition as distinct from .45-inch auto ammunition.
 - (c) .38-inch—Any pistol with a cylinder whose length is one and a half inches or more, will take any .38 American ammunition, revolver type as distinct from auto ammunition.
 - (d) .38-inch—Any pistol with a cylinder whose length is less than one and a half inches (this type generally has cylinders one and a quarter inches long) will take Colt .38-inch *short* ammunition, or British service .38-inch ammunition.

(See Fig. 26, p. 195.)

N.B. There may be one or two exceptions to the above rules, but in general it will be found that they are a sound guide.

COLT .455 INCH REVOLVER

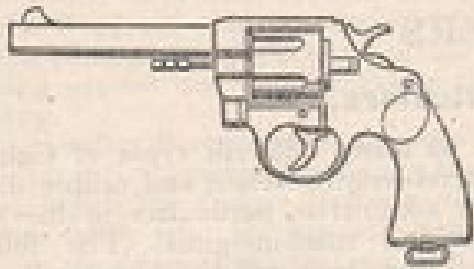

COLT REVOLVER MECHANISM

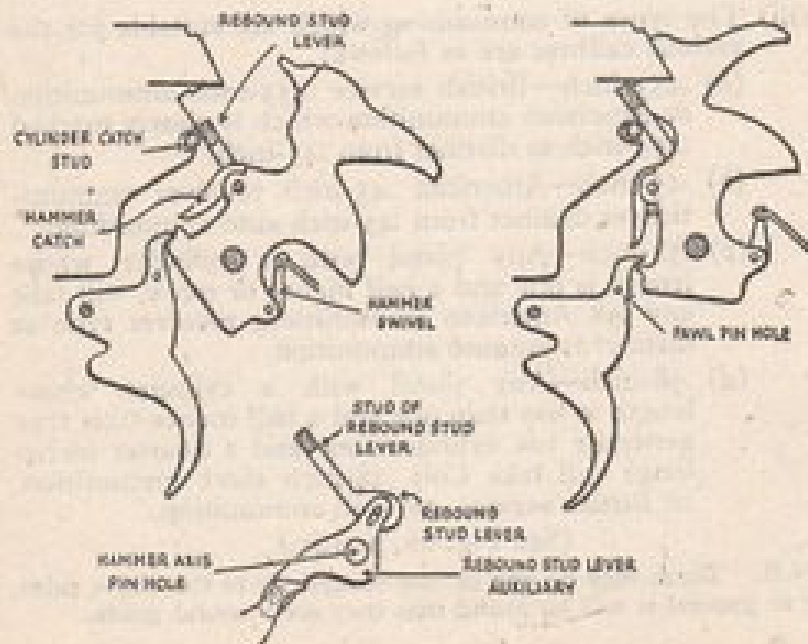

FIG. 26.

REVOLVERS AND AUTOMATIC PISTOLS 196

(b) Stripping and assembling.

(i) To strip.

1. Unscrew screw securing butt grips.
2. Unscrew two screws side plate. The latter is on the left side of the pistol, one screw being just above the trigger and the other immediately above the top of the left butt grip.
3. Ease up the left side plate by means of a screw-driver placed underneath the plate between the two arms of the lockspring and remove complete with cylinder-catch and thumb-piece.

N.B. The mechanism is now completely exposed. Take out the remaining components in the following order.

4. Lift out pawl, easing it up with a screw-driver if necessary.
5. With a punch knock out axis pin of mainspring auxiliary and remove auxiliary.
6. With a pair of pliers press together the long and short arms of the mainspring, and lever out mainspring, disengaging its claws from the arms of the hammer swivel.
7. Rotate hammer backwards until nose is clear of body and lift out.
8. Press trigger forward, withdraw cylinder-catch stud to the rear and remove.
9. Lift out trigger, rebound stud lever auxiliary, and rebound stud lever. They will probably all come out together.
10. Loosen cylinder stop screw on right side of body above front of trigger guard and remove cylinder to the front.

(ii) To assemble.

1. Replace cylinder stop, spring and screw.
2. Replace trigger, rebound stud lever auxiliary, and

197 REVOLVERS AND AUTOMATIC PISTOLS

rebound stud lever as one complete unit, i.e., see that the pins of the trigger and the rebound stud lever are in their respective slots of the rebound stud lever auxiliary.

3. Test these components for correctness of functioning.
4. Insert cylinder-catch stud.
5. Hold trigger to rear and replace hammer.
6. Test for functioning.
7. Replace mainspring auxiliary and axis pin.
8. Replace mainspring by compressing it as when stripping; hook the claws on to the arms of the hammer swivel and place the short arm of the spring on top of the mainspring auxiliary. Thereafter ease the stem of the mainspring into its seating.
9. Test all components again for functioning.
10. With trigger forward, so as to ensure that the mainspring auxiliary lies above the pawl pin, replace pawl by inserting its pin in the hole in the trigger nose. With a screw-driver ease up the nose of the mainspring auxiliary until the pawl can be pushed down and right home.
11. Holding the base of the pawl down with the left thumb (i.e., thumb acting as left side plate) test all components for functioning.
12. Replace side plate, pulling thumb-piece back until cylinder-catch and stud engage. Insert screws in side-plate.
13. Test everything for functioning.
14. Replace butt grips.

General note re stripping and assembling.

There are so many different models of Colt that it is hard to say whether minor differences in the order of stripping and assembling may not be necessary with some of them. The above instructions should, however, serve as a general guide.

REVOLVERS AND AUTOMATIC PISTOLS 198

(c) Notes on mechanism.

1. The cylinder is secured in the firing position by the cylinder-catch stud being pressed home into the recess in the centre of the rear of the cylinder by the cylinder-catch stud spring.
 2. If the cylinder is incompletely engaged, the trigger and hammer cannot be operated owing to the fact that the extractor pushed back the cylinder-catch thumb-piece slightly, which in turn pulls the cylinder-catch stud to the rear sufficiently far to interfere with the normal downward movement of the rebound stud lever, which takes place whenever the trigger is pulled.
 3. Rebound of the hammer is brought about by the shoulder of the mainspring lever, which is being forced down by the mainspring, meeting the rear face of the tail of the hammer and pushing it forward. This causes the hammer to rotate about its axis pin so that the hammer nose is forced back.
 4. Mechanical safety is ensured by the rear face of the tail of the hammer binding against safety face of the mainspring lever. After rebound, therefore, the hammer nose cannot come in contact with the cap of the case or cartridge, i.e. empty or live.
- When the trigger is pulled to the rear the stud of the rebound stud lever comes down behind the cylinder-catch stud and thus the cylinder must be locked in the firing position. If it is not so locked, then the trigger cannot be completely pulled to the rear because the stud of the rebound stud lever fouls the cylinder-catch stud, which protrudes because it cannot be pressed home in the recess in the cylinder.

4. .450-INCH AND .455-INCH COLT AUTOMATIC PISTOLS.

(a) Particulars.

Common names.	Colt .45 auto, and Colt .455 auto.
Weight:	
Loaded.	2 lbs. 11 ozs.
Unloaded	2 lbs. 6 ozs.
Length overall.	8½ ins.
Length of barrel.	4½ ins. including chamber.
Number of rounds in magazine.	Seven.
Ammunition.	.450-in. and .455-in. automatic (i.e. rimless). .455 will NOT fit .450 pistols, but the .450 may be fired in most .455 automatic weapons.
Locked or unlocked.	Locked.
Sights.	Fixed.

(See Fig. 27, p. 200.)

(b) Loading and unloading.

(i) To fill the magazine.

1. First withdraw the magazine from the pistol by pressing the spring catch on the left of the pistol just in rear of the trigger.

2. Holding the magazine in one hand place the base of each cartridge about half-way along the preceding one and then push down and back using both thumbs.

(ii) To load.

Push the magazine well home into the butt, pull back the moving portions as far as possible and allow them to return fully forwards. The pistol is now loaded and cocked.

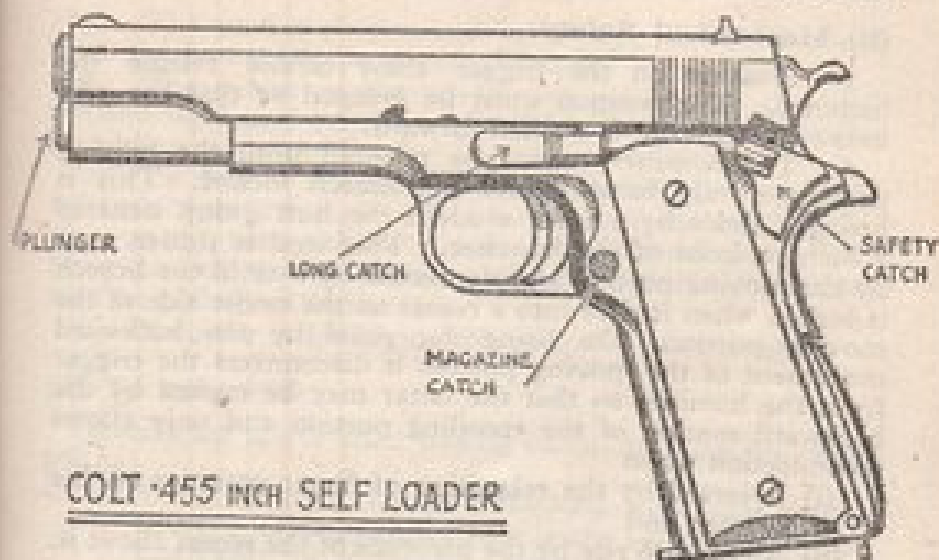

COLT .455 INCH SELF LOADER

FIG. 27.

(iii) To unload.

Remove the magazine. Pull the moving parts back sharply to eject the round in the chamber. Press the trigger.

Note Always remove the magazine FIRST, and pull the moving portion back SECOND.

(c) Applied and mechanical safety.

(i) Applied safety.

There is a catch on the left of the pistol which can only be applied when the hammer is cocked. It then locks both trigger and hammer.

(ii) Mechanical Safety.

1. Pressure on the trigger alone cannot release the hammer. The weapon must be grasped so that the grip below the hammer is pushed forward.

2. The hammer cannot be released until the moving parts are fully forward and the breech locked. This is brought about by a small stud in the butt group situated $\frac{1}{4}$ inch in front of the hammer. This stud is ridden over by the moving portion and depressed by it until the breech is locked when it rises into a recess on the under side of the moving portion. On being depressed by the backward movement of the moving portion it disconnects the trigger from the hammer so that the latter may be cocked by the backward motion of the recoiling portion and only allows reconnection when

- (i) Released by the relaxation of finger-pressure on the trigger, and
- (ii) Allowed to rise by the presence of the recess above it.

(d) Stripping and assembling.**(1) To strip.**

1. Remove the magazine.
2. Press in the knurled head of the return spring plunger underneath the muzzle and rotate the plunger retainer about the barrel to the left. The return spring plunger, return spring, and plunger retainer may then be removed.
3. Slide the moving portion back until the rearward of two small cuts on the lower left edge of the moving portion is above the rear end of the long catch on the butt group which is just above the trigger.
4. This long catch has at its forward end a pin which runs through the pistol from side to side. Press now on the end of this pin protruding from the right side of the pistol and the catch may then be pulled clear to the left.

.45
.455 COLT AUTO

5. The moving portion and barrel may now be removed from the butt group by sliding forwards.

6. The return spring positioning pin should then fall out and the barrel may be removed from the moving portion by sliding out at the front.

7. To remove the firing-pin and the extractor push in the base of the firing-pin with a punch until the small sliding plate at the back can be slid downwards and clear. The firing-pin and spring will now come out and the extractor may be pulled out to the rear.

8. No other stripping should normally be attempted.

(ii) To assemble.

Reverse the above order paying attention to the following points:

- (i) When inserting the pin of the long catch make certain that it goes through the hole in the barrel link. This can easily be tested by trying to move the barrel. There should only be the smallest amount of "play."
- (ii) On completing assembly test the weapon before inserting the magazine by withdrawing the moving portion, letting it go forward and pressing the trigger.

(e) Special features and general information.

1. The locking of the action when the pistol is cocked is accomplished as follows:

- (i) On the top of the barrel just in front of the chamber are two transverse ribs which fit into grooves in the moving portion.
- (ii) As the moving parts go forward the barrel is pushed by the moving portion until the barrel link, pivoting on the long catch pin, forces the rear end of the barrel upwards where it engages in the grooves.

(iii) On firing the pistol remains locked for the short space of time during which the recoil is forcing the moving parts back, causing the barrel link to rotate about the long catch pin and pull the barrel clear of the grooves. This time lag is sufficient to allow the bullet to leave the barrel.

2. When the last round is fired, or if the moving portion is pulled back over an empty magazine, a holding open device will prevent the breech from closing as follows:

(i) The front end of the magazine platform is cut in two, longitudinally, for a short distance, and the left hand part is bent down below the plane of the platform.

(ii) When the magazine is empty this bent part rises and presses against the rear part of the long catch and forces the projection on the top of the latter to engage in the first and larger of the two cuts on the lower left edge of the moving portion.

(iii) To close the breech after firing the last round it is therefore only necessary to depress the rear of the long catch when the moving portion will fly forward. Press the trigger to ease the springs.

5. .38 COLT AUTOMATIC PISTOL.

(a) Particulars.

Common name.	Colt .38 auto.
Weight—Unloaded.	2 lbs. 6 ozs.
Length—Overall.	9½ ins.
Length of barrel.	6 ins., including chamber.
Number of rounds in magazine.	Seven.
Ammunition.	.38 rimless.
Locked or unlocked.	Locked.
Sights.	Fixed.

Note. This pistol should not be confused with pistols of similar make but of .380 calibre. For details of the latter see below. Most pistols are clearly marked .38 or .380 to avoid confusion. Those marked .38 are usually the more powerful.

(b) Loading and unloading.

These operations are in all respects similar to those described above for the .450 Colt automatic except that the magazine catch is at the bottom of the butt instead of at the side.

(c) Applied and mechanical safety.

(i) Applied safety.

There is no safety catch but the hammer may be pulled back to "half cock" which locks all moving parts.

(ii) Mechanical safety.

There is no grip safety lever in this pistol, but arrangements are made to prevent the forward movement of the hammer until the moving parts are fully forward and the breech locked, as in the .450 Colt automatic.

(d) Stripping and assembling.**(i) To strip.**

1. Remove the magazine.
2. Press the plunger below the muzzle and slip out the small cross bar which is situated a short distance back from the plunger and in line with it. This allows the whole of the moving portion to be removed to the rear.
3. The barrel is secured at front and rear to two links which cause it to rise and fall parallel to the axis of the moving parts, thus locking and unlocking the breech. If it is desired to remove the barrel it will be necessary to punch out the two pins which hold the links to the body of the pistol.

(ii) To Assemble.

1. Reverse the above actions.
2. Press the trigger to ease the springs.

(e) Special features and general information.

1. The locking action is similar to that employed in the .450 Colt automatic the only difference being the fact that the barrel is pivoted at both front and rear by means of the two links.
2. The "holding open" device incorporated in this pistol is similar in action to that employed in the .450 Colt automatic.

6. .380 COLT AUTOMATIC PISTOL.**(a) Particulars.**

Common name.	Colt .380 auto.
Weight unloaded.	1 lb. 7½ ozs.
Length overall.	6½ ins.
Length of barrel.	3½ ins. including chamber.
Number of rounds in magazine.	Seven.
Ammunition.	.380 rimless.
Locked or unlocked.	Unlocked.
Sights	Fixed.

(b) Loading and unloading.

These operations are similar to those described above for the .450 Colt automatic except that the magazine catch is situated at the base of the magazine instead of on the left of the pistol near the trigger.

(c) Applied and mechanical safety.**(i) Applied safety.**

There is a safety-catch on the left of the pistol at the top of the butt. This catch can only be applied when the pistol is cocked, and is one indication of whether or not the pistol is in this state or not. This is useful since no hammer is visible in this model as it is concealed under the rear end of the moving portion.

(ii) Mechanical safety.

1. Pressure on the trigger alone cannot release the hammer. The weapon must be grasped so that the grip safety-lever at the back of the butt is pushed forward.

2. Although this pistol works on the "blow-back" principle, and the breech is not locked in any way when the trigger is pressed, arrangements (similar to those described in paragraph (c) (ii) 2 for the .450 Colt automatic) are made to ensure that the hammer cannot go forward until the breech is completely closed.

(d) Stripping and assembling.**(i) To strip.**

1. Remove the magazine.
2. Pull back the moving portion until a small line, indicated by an arrow thus | ← engraved on the right side of the lower part of the moving portion just below the muzzle, coincides with the front edge of the body of the pistol. This uncovers the forward end of the barrel.
3. Hold the moving portion in this position and with the disengaged hand turn the barrel as far as it will go in an anti-clockwise direction (looked at from the front).
4. Let the moving portion come forward under the influence of the return spring and slide it and the barrel off the front end of the body.
5. The barrel may now be removed from the moving portion by twisting it back to its original position and withdrawing it to the front. The return spring and guide rod may also be removed.
6. No further stripping should be attempted.

(ii) To assemble.

1. Reverse the above actions.
2. Press the trigger to ease the springs.

(e) Special features and general information.

1. The barrel is held in position relative to the body by means of six ribs, similar to interrupted screw threads, underneath the chamber which normally fit into six corresponding grooves in the body.

When the barrel is turned in stripping the weapon these ribs disengage from the grooves but another rib about half-way along the barrel engages in a groove near the front of the moving portion so that when the latter has been slid off the body it is necessary to twist the barrel again, as described in paragraph (d) (i) 5, to remove it from the moving portion.

2. There is no "holding-open" device in this pistol and therefore to avoid pressing the trigger with an empty breech it is necessary to count the rounds fired and also to re-cock the weapon after changing magazines.

7. SMITH AND WESSON .455, .38, AND .45 D.A. REVOLVERS

(a) Particulars.

Here again there are so many different types as regards barrel-length, weight, etc., that it is impossible to summarize particulars in the same way as for rifles and machine-guns. The following, however, are the main particulars which are applicable to the principal types.

- (i) The cylinder has six chambers.
- (ii) It revolves *anti-clockwise*.
- (iii) The types of ammunition which are suitable for the various calibres are as follows:
 - (a) .455-inch.—British service .455-inch or American ammunition which is clearly marked .455-inch as distinct from .45-inch.
 - (b) .45-inch.—American .45-inch revolver ammunition as distinct from .45-inch auto ammunition.
 - (c) .45-inch D.A.—.45-inch auto ammunition (e.g. as used in the Thompson machine carbine) in conjunction with two special three-round clips.

NOTE.—1. The pistol will not fire rimmed ammunition.

2. Without the special clips automatic extraction will not take place; each case will have to be pushed out separately with a pencil or other suitable instrument.

- (d) .38-inch.—Any pistol with a cylinder whose length is one and a half inches or more will take any ammunition of American manufacture of .38-inch calibre, provided that it is revolver type as distinct from auto.

(See Fig. 28, p. 210).

N.B. Here also, as in the case of the Colt, there may be a few exceptions, but the above may be taken as a good general guide.



.455 INCH SMITH & WESSON

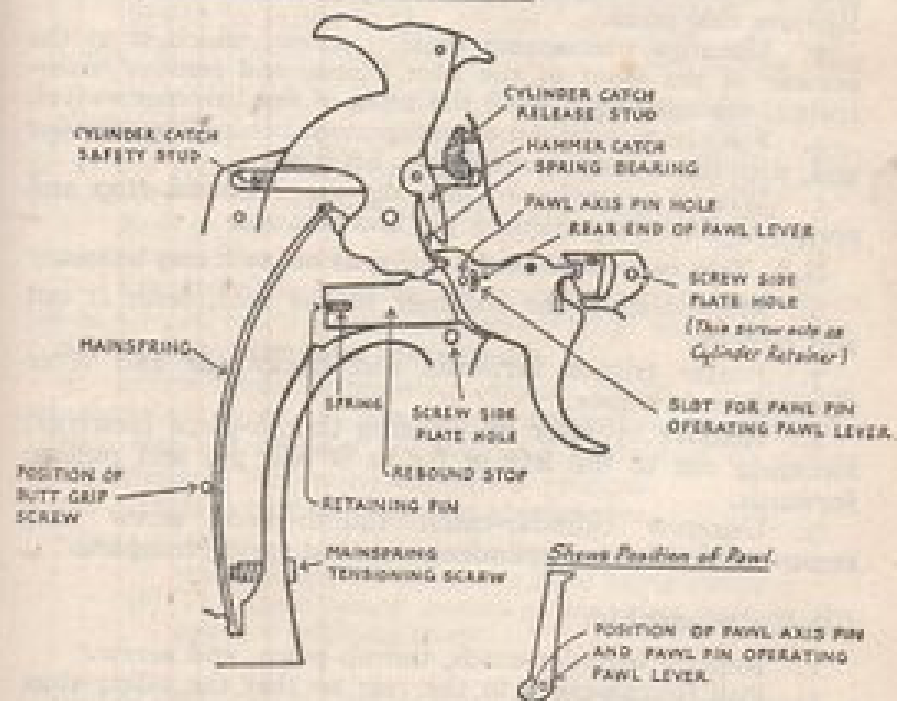

SMITH & WESSON .455, .45 & .38 INCH.

(b) Stripping and assembling.

(i) To strip.

1. Unscrew screw securing butt grips.
2. Unscrew the four screws securing side plate. The latter is on the right-hand side, instead of the left as in the case of the Colt. Two screws are just above either end of the trigger guard, one just on top of the back of the right grip and the other just in rear of the top of the cylinder. Remove side plate.
3. Unscrew mainspring tension screw, which is at the bottom of the front of the butt frame, and remove mainspring, disengaging it from the arms of the hammer swivel.
4. Push back pawl out of engagement behind the cylinder and, with the aid of a screwdriver, lift it out.
5. With a screwdriver ease up the rebound stop and spring to clear the retaining pin and remove.

N.B. Take care not to let the spring fly out or it may be lost.

6. Manipulating the hammer to the rear, lever it out and remove.
7. Rotate trigger forwards and backwards and lever upwards and remove.
8. Remove cylinder by pressing thumb-piece forwards, swinging out to the left as far as it will go, and pulling forwards.
9. Unscrew cylinder-catch thumb-piece screw and remove thumb-piece, cylinder-catch and spring complete.

(ii) To assemble.

1. Replace cylinder-catch, thumb-piece, and screw.
2. Pull thumb-piece to the rear so that the safety-stop clears the hammer, and replace the hammer.
3. Assemble pawl to the trigger, making sure that:
 - (i) The pawl lever spring stud at the front of the pawl

- S & W
- lever is correctly placed on top of the pawl lever spring, and
 - (ii) The rear of the pawl lever is on top of the pawl pin operating pawl lever, before inserting the pawl axis pin into its hole in the bottom of the trigger nose.
 4. Push hammer forward and assemble trigger and pawl complete, making sure that:
 - (i) The nose of the trigger lies between the bent of the hammer and the hammer-catch.
 - (ii) The cylinder stop lever at the front of the trigger lies in its recess in the cylinder stop, and
 - (iii) The rebound stop connecting rod of the trigger does not fall below the trigger guard.
 5. Place the front end of the rebound stop behind the rear of the trigger and, with the aid of a screw-driver, compress the rebound stop spring and lever the rebound stop and spring down into place behind their retaining pin.
 6. Engage claws of the mainspring behind the arms of the hammer swivel and replace mainspring.
 7. Put sufficient tension on mainspring to keep it in place, i.e., screw in mainspring screw *about half-way home*.
 8. Replace butt grips and screw.
 9. Screw home mainspring tension screw. The screw securing butt grips acts as a stop to prevent over tensioning.
 10. Replace cylinder by inserting spindle in its recess and pushing in the spring-supported plunger.
 11. Replace side plate and its four screws.

- N.B. (a) The shortest screw is the one just behind top rear of the cylinder, the remaining three being common.
 (b) The front screw retaining side plate acts as the cylinder retaining screw.

General note regarding stripping and assembling.

The above instructions will serve as a general guide for all types of Colt revolvers.

(c) Notes on mechanism.

1. The cylinder is secured in the firing position by the cylinder-catch stud, which is spring supported and lies in the centre of the extractor, entering and being held in position in its recess in the body under the influence of its spring.

2. If the cylinder is not properly closed, the trigger and hammer cannot be operated owing to the interference of the safety stud, which is on the rear of the cylinder-catch release stud. This is brought about by the fact that the latter is allowed to enter the cylinder-catch stud recess in the body owing to the absence of the cylinder-catch stud.

3. Rebound of the hammer is brought about by the rebound stop being forced forward under the influence of its spring. The shape of the forward end of the rebound stop and the rebound arm of the hammer is such that the forward movement of the rebound stop pushes the lower part of the hammer forwards, thus rotating the nose of the hammer to the rear.

4. Mechanical safety is ensured by the face of the rebound arm of the hammer bearing hard against the top of the rebound stop and binding. After rebound therefore the hammer nose cannot go forward and contact the cap of the cartridge.

8. 9mm. BORCHARDT-LUGER (PARABELLUM) AUTOMATIC PISTOL

(a) Particulars.

Common name.	9 mm. Luger.
Weight.	2 lbs.
Length.	8½ ins.
Length of barrel.	3.9 ins.
Number of rounds in normal magazine.	} 8 rounds.
Ammunition	
Locked or unlocked.	Locked by toggle joint.

There is a longer type with a special holster. The latter can be fitted on to either the long or short pistols to serve as a butt for reasonably accurate shooting at distances in excess of normal pistol ranges.

(See Fig. 29, p. 215).

(b) Loading and unloading.**(1) Loading.**

1. Place the mouth of a full magazine in the magazine opening in the bottom of the butt, and press home until you hear or feel the magazine-catch engage.

2. Holding the butt of the pistol in the right hand, take hold of the two knurled knobs of the crank with the thumb and forefinger of the left hand, and pull smartly upwards and backwards, and then leave go of the crank. The above action will cock the weapon and at the same time the top round in the magazine will be fed into the chamber.



9 MM. BORCHARDT-LUGER PARABELLUM.

FIG. 29.

(ii) Unloading.

1. Remove magazine by pressing in magazine-catch, which lies on the left side of the pistol just behind the trigger.
2. Carry out the loading motion of pulling the crank back and letting it go. This will extract the round in the chamber and, since the magazine had *previously* been removed no other round will be fed in.
3. Release springs by pulling the trigger.

(c) Applied and mechanical safety devices.

(i) Applied safety.

There is a safety-catch on the left side of the body at the top of the butt. There are two positions for the catch, i.e., at

about 50 degrees to the horizontal, which is the "ready" position (this position is the more forward of the two), and further back at about 30 degrees to the horizontal which is the "safe" position. The movements of the catch from the ready to the safe position uncovers the word "Gesichert" which denotes "SAFE."

(ii) Mechanical safety.

If the trigger is pulled when the action is not fully locked, the trigger-bar cannot press in against the sear tail since the latter is too far to the rear owing to the recoiling parts not being fully forward.

(d) Stripping and assembling.

(i) Stripping.

1. Remove the magazine.
2. Push back barrel slightly and then turn down to the vertical position the thumb-catch just in front of the trigger guard.
3. Lift out the covering plate.
4. Draw off to the front the barrel, receiver, and the recoiling portions as a complete assembly.

Note. In general there should not be any need to strip further than this. The trigger comes out quite easily, but it is better left where it is since clumsy handling can damage the trigger-spring while assembling it again.

(ii) To assemble.

1. Replace the barrel, etc., assembly from the front. It is best to do this with the pistol upside down in order to prevent the hook at the rear of the receiver from dropping into the wrong recess. See that the ribs on the receiver correctly enter the grooves on the body. At the moment when the hook already mentioned is just in rear of the back of the magazine opening and in front of the inclined ramps,

turn the pistol the right way up. The hook will then drop into its correct place, which is in front of the underside of the inclined ramps. Push the receiver back as far as it will go without force being used.

2. Replace the covering plate, making sure that the rear tongue is inserted in its recess in the body and that the projecting portion of the trigger-bar enters its slot at the top of the trigger.

3. Push back barrel and turn catch in front of trigger of trigger guard back to its original horizontal position.

(e) Special features and general information.

1. There is a holding-open device to indicate when the magazine is empty. A small stud on the right side of the magazine rises with the magazine platform, to which it is connected. When the last round has been fed into the chamber, the stud is pressing up against a cross-member in the bolt-way which is normally kept out of the way by its own spring, which, however, is weaker than the magazine spring. As soon as the recoiling portions and breech bolt have come back far enough, the cross-member rises and interferes with the forward movement of the breechbolt.

2. The breech is locked at the moment of firing in the same manner as the Vickers machine-gun, i.e., a toggle joint, the centre axis of which lies below the other two axes, and is firmly supported underneath. Recoil of about a quarter of an inch occurs before the toggle is broken and the crank begins to rotate under the influence of contact with the inclined shoulders at the rear of the body.

9. 7.63 MM. AND 9 MM. MAUSER AUTOMATIC PISTOL.

(a) Particulars.

Common name.	Mauser pistol
Weight.	2 lbs. 8 ozs.
Weight with wooden holster.	} 3 lbs. 10 ozs.
Length.	11 ins.
Length of barrel.	5½ ins.
Number of rounds in magazine.	} 10 rounds.
Ammunition	{ 7.63 mm. } Mauser. 9 mm.

Many, but not all, of the 9 mm. weapons will take Parabellum ammunition, as used in machine carbines. (See note on p. 10).

Locked or unlocked.	Locked by rising link engaging bolt.
Type of sights.	Open.
Range of adjustment.	50-500 metres. In some cases the sight may be graduated to 600 or 1,000 metres.

(See Fig 30, p. 219).

This pistol is commonly found with a wooden holster which can be fitted as a butt and enables the weapon to be used for reasonably accurate shooting at distances greater than the normal range of pistols.

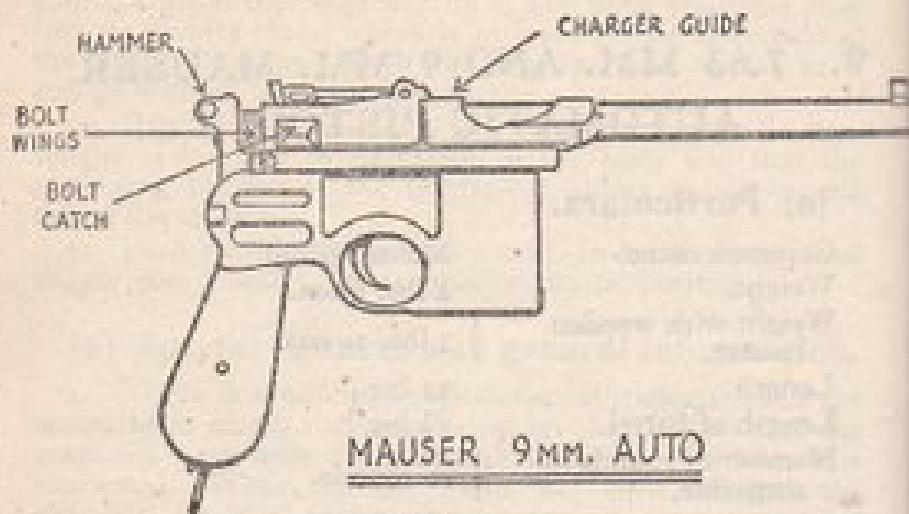

FIG. 30.

(b) Loading and unloading.

(i) To load.

1. Pull back the bolt, by means of the ribbed wings at the back, to its full extent. This will cock the hammer and also allow the magazine platform to rise and prevent the bolt closing again on an empty breech.

2. Insert a charger into the guides in rear of the breech and push the rounds steadily into the magazine.

3. Remove the charger and the bolt will close carrying the first cartridge into the breech.

(ii) To unload.

1. Work the bolt backwards and forwards until it is held open by the magazine platform.

2. Holding the bolt back with one hand depress the magazine platform with the thumb of the other hand and

ease the bolt forward, making sure no cartridge has been left in the breech.

3. Press the trigger.

Note. An alternative method, not to be recommended, is to remove the magazine base plate, spring and platform, when the rounds will fall out. It would then only be necessary to work the bolt once to clear the cartridge in the chamber, press the trigger and replace the magazine platform, spring and base plate.

(c) Applied and mechanical safety devices.

(i) Applied safety.

There is a catch on the left of the body beside the hammer. When this is horizontal the pistol may be fired or cocked. When it is pushed up as far as it will go (an angle of about 60 degrees to the horizontal) the pistol is SAFE. The catch may be applied whether the hammer is cocked or not. In the fired position the hammer is withdrawn from the firing-pin and locked. In the cocked position the hammer is withdrawn clear of the sear and locked.

(ii) Mechanical safety.

1. The bolt is locked in its fully closed position by means of a link until the barrel and barrel extension have recoiled about an eighth of an inch, by which time the bullet is clear of the barrel.

2. By means of the same link, on the forward motion of the moving parts although the hammer is already cocked, the trigger is not reset until the bolt is again locked in the forward position.

(d) Stripping and assembling.

(a) To strip.

1. With the point of a bullet press up the stud in the

REVOLVERS AND AUTOMATIC PISTOLS 222

221 REVOLVERS AND AUTOMATIC PISTOLS

magazine base plate, slide the plate forward slightly and withdraw with magazine spring and platform.

2. Cock the hammer, press up the body catch just below the base of the hammer and pull back the barrel, barrel extension and hammer mechanism clear of the body.

3. The hammer mechanism is then easily removed from the barrel extension, from which the link member can also be detached. (Care should be taken that the body catch does not drop out of the hammer mechanism block and become lost.)

4. The bolt may be removed from the barrel extension as follows:

(i) With a small screwdriver press in the rear of the firing-pin and give a quarter turn clockwise. The firing-pin may then be withdrawn.

(ii) Push forward the bolt catch on the right of the barrel extension and pull out to the right. This releases the bolt return spring and frees the bolt for withdrawal to the rear.

(II) To assemble.

1. Slide bolt into barrel extension and with the blade of a screwdriver (which should be as wide as the diameter of the spring) compress the bolt return spring until it is possible to insert the bolt catch behind it.

2. Insert firing-pin, making certain that it goes through the hole in the bolt catch. Push forward and give a quarter turn anti-clockwise to secure.

3. Hold barrel group upside down, place link over link pillar, place hammer mechanism over link, making sure that the hammer is cocked, and press home until the ejector which projects at the front of the mechanism fits into the slot on the underside of the bolt. Press down the hammer mechanism and draw the body over it from the front until the body catch engages in the body.

4. Turn pistol the right way up and press the trigger.
5. Insert magazine platform and spring, and slide home magazine base plate.

(e) Special features and general information.

1. To distinguish them from the 7.63 mm. models the 9 mm. pistols usually have a large 9 carved in each side of the pistol grip. This figure is, in addition, sometimes painted red.

2. This weapon is a very good example of the earlier and more complicated automatic pistols; it was used considerably by the Boers in the South African War, and has only changed in one or two minor particulars since then. The modern trend, however, is towards greater simplicity, mainly on account of speed and cost of production to which such parts as the hammer mechanism block, with its many bearing surfaces and complicated shape, do not lend themselves.

10. 9mm. WALTHER MODEL .38 AUTOMATIC PISTOL (GER- MAN).

(a) Particulars.

Common names.	P.38, or 9mm. Walther auto.
Weight:	
Loaded.	2 lbs. 5 ozs.
Unloaded.	2 lbs. 2 ozs.
Length, overall.	8½ ins.
Length of barrel	4½ ins. including chamber.
Capacity of magazine.	8 rounds.
Ammunition.	9 mm. Parabellum. (See note on p. 10).
Locked or unlocked.	Locked by rising block.
Sights.	Fixed.

(See Fig. 31, p. 224.)

(b) Loading and unloading.

(i) To fill magazine.

1. Withdraw magazine by pushing back the catch at the base of the pistol grip, when the magazine should spring out far enough to enable it to be gripped in the fingers.
2. Place the base of each round just in front of the magazine lips and press down and backwards into place.

(ii) To load.

1. Push magazine home into pistol grip.
2. Pull the slide back as far as possible and allow it to run forwards under the influence of the return spring.

Note. It does not matter whether the safety-catch is in the horizontal FIRE position or whether it has been turned down to the SAFE position. In the former case the weapon is now



FIG. 31.

cocked and ready to fire, in the latter case the hammer will be in the fired position and to fire it will only be necessary to set the safety-catch to FIRE and press the trigger. It is NOT necessary to cock the hammer as this pistol has a "double action" hammer mechanism.

3. If the safety-catch is not at SAFE move it downwards into this position. This will release the hammer which will fly forward but will NOT fire the round in the chamber.

(iii) To unload.

1. Remove magazine.
2. With safety-catch in either position pull back the slide as far as possible to remove round from chamber and let it run forward.
3. If the safety-catch is set at FIRE move it to SAFE; this will release the hammer and thus ease the springs.

(c) Applied safety.

1. There is a safety-catch on the left of the weapon near the rear end of the slide. This may be moved from FIRE to SAFE whether the pistol is cocked or uncocked.

(i) If the pistol is cocked the hammer will be released and will come forward without firing the round in the chamber since the firing pin is locked before the hammer hits it. It is then impossible to press the trigger as it is fully retracted.

(ii) If the pistol is uncocked the pressing of the trigger cannot fire the pistol as the hammer is prevented from moving back far enough to be released. In any case the firing-pin is locked, although the trigger is not fully retracted.

2. If, whilst the safety-catch is at SAFE, the slide is pulled back the hammer will not remain cocked when the slide moves forward again but will be released as at (i) above when the slide reaches the end of its forward movement.

(d) Stripping and assembling.**(i) To strip.**

1. See that the safety-catch is at SAFE.
2. Remove the magazine.
3. Pull back the slide with one hand and, with the other, raise the holding open catch into engagement.
4. Turn the locking lever forward as far as it will go. (This lever is on the left side of the weapon in front of the trigger guard.)
5. Holding the slide under control depress the holding open catch and remove slide and barrel to the front.
6. Turning the slide and barrel upside down, push forward the small plunger at the rear of the barrel assembly. This will unlock the white metal locking block and enable the barrel to be removed from the slide.

7. The locking block may now be removed from the barrel.

8. No other stripping should be attempted.

(ii) To assemble.

1. Replace locking block in barrel assembly, and see that the lugs on each side of it are in line with the wide ribs on the barrel.

2. Push the barrel assembly into the slide as far as possible and then push the locking block upwards into the locked position.

3. See that the hammer is forward in the uncocked position and that all moving parts in the body are below the level of the flat bearing surfaces at the rear end.

4. Holding the locking block in the locked position and with the safety-catch at SAFE push the slide and barrel on to the body, pushing the slide fully back and holding it in that position by raising the holding-open catch.

5. Turn the locking lever back to the locked (horizontal) position.

6. Depress the holding open catch thus allowing the slide to move forward.

7. Insert the magazine.

(e) Points of interest.

The chief point of note is that this pistol, although automatic, has a double action hammer mechanism more usually found in revolvers. This enables the weapon to be carried loaded but at SAFE with the hammer uncocked and yet be ready for instant action without having to cock it.

11. 9mm BERETTA MODEL 1934 AUTOMATIC PISTOL (ITALIAN).

(a) Particulars.

Weight:	
Unloaded.	1½ lbs.
Loaded.	1 lb. 10 ozs.
Length overall.	6 ins.
Length of barrel.	3½ ins. including chamber.
Capacity of magazine.	Seven rounds.
Ammunition.	9 mm. short (corto). Standard rimless .380 ammunition will fit this pistol. Parabellum or Mauser ammunition will NOT fit; both are too long. (See note on p. 10).
Locked or unlocked.	Unlocked.
Sights.	Fixed.

(See Fig. 32, p. 228.)

(b) Loading and unloading.

(i) To fill magazine.

1. Withdraw magazine from pistol by pushing back the catch at the base of the pistol grip and pulling downwards on the tongue on the front of the base of the magazine.
2. Place the base of each round just in front of the magazine lips and press down and backwards into place.

(ii) To load.

1. Push magazine home into pistol grip.
2. See that the safety-catch on the left of the weapon is in the fully forward (FIRE) position, the letter F and the red dot being visible.



FIG. 32.

3. Pull the slide back as far as possible and let it go forwards under the influence of the return spring. The pistol is now ready to fire.
4. Apply the safety-catch by moving it as far as possible to the rear (thus uncovering the letter S).

Note. If desired the hammer may be lowered before applying the safety-catch by holding it with one hand, pressing the trigger and letting the hammer go forward gently. In this case the hammer must be cocked by hand before the weapon can be fired; this may be done either before or after releasing the safety-catch.

(iii) To unload.

1. Remove the magazine.

2. Push the safety-catch forward.
3. Pull back the slide to eject the round in the chamber, and allow to move forward again.
4. Press the trigger to ease the springs.

(c) Applied and Mechanical safety.

(i) Applied safety.

The safety-catch locks the trigger but not the hammer. It is therefore possible to cock the pistol with the safety-catch applied, and with a defective weapon it might be possible to fire by giving the pistol a sharp jerk or knock although the safety-catch was applied. It is better therefore with this pistol to leave the hammer uncocked whenever possible.

(ii) Mechanical Safety.

It is not possible for the hammer to be released until the slide is fully forward. This is brought about by means of a disconnecter, the upper tongue of which protrudes above the bakelite grip on the left side of the pistol and normally rises into and moves backwards in, a groove cut in the underside of left flange of the slide when the trigger is pressed. If the slide is not fully forward the disconnecter tongue cannot rise and only moves backwards disconnecting the trigger from the hammer.

(d) Stripping and assembling.

(i) To strip.

1. Remove the magazine.
2. Turn safety-catch to rear (SAFE).
3. Pull back slide as far as possible, safety-catch will then jump up into notch on lower edge of left of slide thus holding slide to rear.
4. Push barrel to rear and lift out breech end first.
5. Holding slide, under control turn safety-catch fully forward (FIRE) and remove slide from front end of body.

6. Remove return spring, return spring rod and safety-catch.

Note. No other stripping should normally be attempted.

(ii) To assemble.

1. Insert safety-catch, turned to rear (SAFE).
2. Insert return spring and rod; the collar on the rod being to the rear.
3. Push slide on to body from front and push rearwards until it is held in the rear position by the safety-catch engaging in the notch as before.
4. Insert the barrel, muzzle first and push forward so that the tongue below the chamber engages in the recess in the body.
5. Turn safety-catch forward (to FIRE) releasing slide and allowing it to move forward.
6. Press trigger to ease springs.
7. Insert magazine.

(e) Points of interest.

1. On firing the last round in the magazine the magazine platform rises and prevents the breech from closing. Removing the magazine, however, allows the slide to move forward so that when a full magazine is inserted it will again be necessary to pull back the slide to load.
2. There is a "half-cock" position of the hammer. This is normally not a requirement where a safety-catch is provided.

Note. There is also a 7.65 mm. (.32 in.) calibre version of this pistol. Weights and dimensions, except for the barrel, chamber and magazine, are the same as for the 9 mm. model.

(Do not fill in here anything that should be secret from the enemy.)

AMMUNITION. 0.303 MKS. VII. MRS VIII.

TYPE	CODE LETTER ON BASE	ANNULUS COLOUR	BULLET TIP COLOUR
DUMMY	CASE IS SILVER WITH 3 RED GROOVES.		
PRACTICE	P	PURPLE	PURPLE (WOODEN BASE)
BLANK	—	PURPLE	PURPLE
BALL	—	PURPLE	PURPLE
S.A.P.	F	GREEN	—
A.P.	W	GREEN	—
S.A.P. TRACER	FG	GREEN	—
A.P. TRACER	WG	GREEN	—
TRACER	G	RED	— GREY
INCENDIARY	—	BLUE	—
EXPLOSIVE	—	BLACK	—
OBSERVING	—	BLACK	RED.
PROOF	GMKI	(RARE TIP IN BULLET REPLACED BY PHOSPHORUS PASTE) YELLOW. { CASE REDDENED. DEVELOPES EXTRA } { HIGH PRESSURE FOR NEW RIFLE TESTS } { BY INSPECTORS }	

NOTE:- THERE IS NO S.A.P. EXPLOSIVE IN 0.303.

GRENAD CHARGES.

CORDITE.	ALL BLACK CASE.
BALLISTITE	1/2 BLACK CASE

0.22. MK I NR.

NORMAL.	COPPER CASE.
HIGH VELOCITY	BRASS CASE

ROYAL ARMOURD CORPS.

0.312" - 7.92" M	} SAME AS ABOVE. + S.A.P. EX.
0.591" - 15" M	

PENETRATION OF A 0.303 BULLET.

HARD STEEL	7/16"	SAND BAGS	18"
SHINGLE	6"	HARD WOOD	38"
BRICKWORK	9"	UNRAMMED EARTH	40"
CEMENT MORTAR	9"	SOFT WOOD	58"
LIME MORTAR	14"	CLAY	60"
CHALK	15"	DRY TURF OR PEAT	80"

RAMMING EARTH REDUCES ITS RESISTANCE.

AMMUNITION 0.300. (U.S.A.)

NOTE:- ALL U.S. AMMO. IS TRACER. ?

GRENAD CHARGES.

BALLISTITE END OF CASE IS CRIMPED, SOMETIMES A BLUE SPLASH ON CAP.

NOTES

DESCRIPTION OF THE MACHINE

The machine is a...
It is a...
The...
The...
The...

The...
The...

The...
The...

The...
The...

The...
The...
The...
The...

NOTES

DESCRIPTION OF THE MACHINE

The...
The...

The...
The...

The...
The...

The...
The...

The...
The...

The...
The...

The...
The...

The...
The...

The...
The...

The...
The...

The...
The...

The...
The...

The...
The...

The...
The...

The...
The...

A companion book for

HOME GUARDS

THE HOME GUARD TRAINING MANUAL

Edited by Major John Langdon-Davies, M.B.E.

Based by permission on W.O. Training
Instructions

With 2 chapters on Rifle and Lewis Gun firing
and maintenance by

BRIGADIER J. A. BARLOW, S.A.C.

Sections also on Nazi Warfare, Village Defence,
Gas Warfare, Anti-Tank, Drill and Discipline,
Anti-Air War.

New and Revised Edition. 9th Printing. 2s. net.

Approved by W.O. for H.G. issue

Of all Booksellers

JOHN MURRAY & THE PILOT PRESS

A new HOME GUARD Book by
MAJOR JOHN LANGDON-DAVIES, M.B.E.

FIELDCRAFT TRAINING MANUAL

for Home Guards

Based on the Courses given at Maj. Langdon-Davies' School at his Farm in Southern England under War Office arrangements.

Scouting—Tracking—Personal Camouflage—Map
Reading, etc.

Fully Illustrated

4th Printing.

2s. net

Of all Booksellers

JOHN MURRAY & THE PILOT PRESS

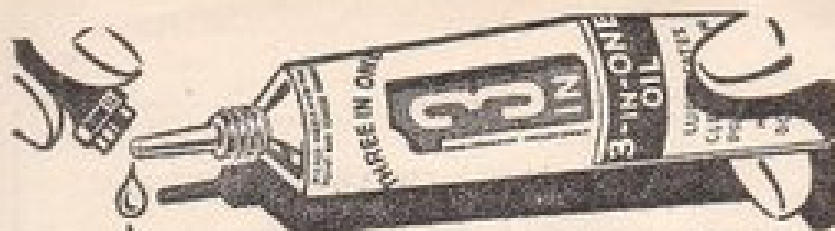

**HOME GUARD! . . . 'SHUN!
HERE'S 'THREE-IN-ONE'...**

Give your rifle what it needs most—
'Three-in-One,' the triple action oil,
now obtainable in handy tubes or bottles.
No waste in use or leakage when carried
in your kit. Just a spot gives smoother
action and prevents rust and pitting.

There are innumerable uses in the home
for 'Three-In-One'—the oil which pene-
trates and will not clog.

From all Gunsmiths, Ironmongers
and Hardware Dealers. 8d., 1/- and
2/6. (Exempt from Purchase Tax).



3-IN-ONE OIL
THE OIL OF 301 USES



HUSSAR
THE
**BRUSHLESS
SHAVING CREAM**
WHICH
lathers

Think of the best brushless shave you've ever had. Add a close non-bubbling, creamy, active, lasting lather—and you have HUSSAR. HUSSAR will give you smoother, quicker, slicker shaves than ever before. Requiring neither soap, brush nor water, HUSSAR is as easy to use in the desert as it is in the bathroom. Try HUSSAR today for the perfect shave; it's the shave cream for which men have been waiting.

BROADWAY SURGICAL BUREAU, LONDON, W.1.

A Jean Claude Product

www.vickersmachinegun.org.uk

STAFFS, ALSO
REPAIRS, ETC.



EST. 1810

DRUMS, FLUTES,
BUGLES, PIPES.

Henry Potter & Co.,

36/39, WEST STREET, CHARING CROSS ROAD, W.C.2

London

“ DRUMS ”

Specialists in Painting and Heraldry
Sterling Silver Embroidery

Pipe Banners, Colour Belts, Drum Bases, Regimental
Colours, Drum-Majors' Sashes, Etc.

★ *Military Catalogue or* ★
Cadet Guide on application.



The old army excuse won't wash to-day. There may be only half the previous supply of razor blades for sale, but if you can buy a KLEEN Blade, you can make it last for days and days and days. KLEEN Blades are the thinnest, most highly tempered, longest lasting Sheffield steel. Always strop the blade on the palm of the hand before and after using it. Dry it well after use and unscrew razor slightly as blade gets older.

*Made from Sheffield's finest
razor steel in a 40-hour-week
factory.*

DOUBLE EDGE 6 for 6d
(plus 1½d. tax)

SINGLE EDGE 4 for 6d
(plus 1½d. tax)



ASK FOR THEM IN THE CANTEN

NO INCREASE IN PRICE OTHER THAN PURCHASE TAX
W. R. SWANN & CO. LTD - PENN WORKS - SHEFFIELD

